

UJNR

TSUKUBA 2011

**PROCEEDINGS OF
THE 43RD JOINT MEETING
OF U.S.-JAPAN PANEL ON
WIND AND SEISMIC EFFECTS
UJNR**

August 29 - 30, 2011
TSUKUBA, JAPAN

Public Works Research Institute

Copyright © (2012) by P.W.R.I.

All rights reserved. No part of this book may be reproduced by any means, nor transmitted, nor translated into a machine language without the written permission of the Chief Executive of P.W.R.I.

この報告書は、土木研究所理事長の承認を得て刊行したものである。したがって、本報告書の全部又は一部の転載、複製は、土木研究所理事長の文書による承認を得ずしてこれを行ってはならない。

PROCEEDINGS OF THE 43RD JOINT
MEETING OF U.S.-JAPAN PANEL ON
WIND AND SEISMIC EFFECTS
UJNR

Edited by

Keiichi Tamura, Secretary-General
Japan-side Panel on Wind and Seismic Effects

Synopsis

This publication contains the proceedings of the 43rd Joint Meeting of the U.S.-Japan Panel on Wind and Seismic Effects, UJNR. The meeting was held at the National Institute for Land and Infrastructure Management, Tsukuba, Japan during August 29-30, 2011. Ten technical papers featuring the 2011 Great East Japan Earthquake were authored for the meeting.

Keywords: *wind engineering, earthquake engineering, sustainable design, natural disaster prevention, 2011 Great East Japan Earthquake, UJNR*

PREFACE

This publication contains the proceedings of the 43rd Joint Meeting of the U.S.-Japan Panel on Wind and Seismic Effects, UJNR. The meeting was held at the National Institute for Land and Infrastructure Management, Tsukuba, Japan during August 29-30, 2011. The proceedings include the program, list of members, task committee reports, and technical papers submitted to the Joint Panel Meeting.

BACKGROUND

Responding to the need for improving engineering and scientific practices through exchange of technical data and information, research personnel and research equipments, the United States and Japan created the U.S.-Japan Cooperative Science Program in 1961. The U.S.-Japan Cooperative Program in Natural Resources (UJNR) was created in January 1964. The objective of UJNR is to exchange information on research results and scientists and engineers in natural resources of benefit of both countries. UJNR is of 18 Panels each responsible for specific technical subjects.

The Panel on Wind and Seismic Effects was established in 1969. Twenty-one U.S. and seven Japanese agencies currently participate to develop and exchange technologies aimed at reducing damage from high winds, earthquakes, storm surge, and tsunamis. This work is produced through collaboration between U.S. and Japanese member researchers working in five Task Committees. Each Task Committee focuses on specific technical issues, e.g., buildings and infrastructure systems. The Panel provides the vehicle to exchange technical data and information on design and construction of civil engineering infrastructures, buildings, and to exchange high wind and seismic measurement records. Annual Joint Panel Meetings alternate in the U.S. and Japan. These technical meetings including technical site visits provide the forum to discuss on-going research and research results.

The National Institute of Standards and Technology (NIST) provides the U.S.-side chairman and secretary-general. The Public Works Research Institute (PWRI) provides the Japan-side chairman and secretary-general.

These annual Joint Panel Meetings provide the mechanism for interaction with U.S. and Japanese researchers in wind and earthquake engineering which provides opportunities to gain valuable information and to engage in cooperative research. Through these opportunities the Panel member organizations have realized important advances in building and structure technology.

The Panel provides the vehicle to exchange technical data and information on design and construction of civil engineering lifelines, buildings, waterfront, and coastal structures. The data produced by the Panel influence on-going structural engineering research and contribute to the revision and creation of U.S. building codes and standards. Examples of Panel benefits include:

- Created and exchanged digitized earthquake records used as the basis of design and research for Japan and the U.S.
- Produced full-scale test data that advanced seismic design standards for buildings.
- Translated into English a Port and Harbour Research Institute handbook on *Liquefied Remediation of Reclaimed Land*, A. A. Balkema, The Netherlands, publisher that provided general guidance for the US design profession on remediation of liquefiable soils.
- In collaboration with Japan's Geotechnical Society translated into English a report from the Port and Harbour Research Institute, *Remedial Measures Against Soil Liquefaction: From Investigation and Design to Implementation*, A. A. Balkema, The Netherlands, 1998, publisher that served as background and guidance for the Corps of Engineers in performing dam remediation at Clemson University.
- Developed a protocol for testing bridge columns subjected to earthquake loads that facilitated the exchange of experimental data between both countries. The protocol serves as a basis for FHWA's development of new seismic design criteria for bridge columns.
- Facilitated an USACE Team to Kobe within days after the Kobe Earthquake that allowed access to data and information through performing post disaster investigations. This investigation would not have been possible without the Panel's endorsement.
- Performed joint post disaster investigations whose findings influenced revisions to and development of new seismic design and rehabilitation criteria in the US.
- Accessed a large US and Japan database that helped develop an USACE Guidance Criteria in Geotechnical Engineering.
- Provided access to data to help characterize gravely soils in determining the seismic instability of gravely soils for dams and were used to improve USACE construction criteria.
- Through a Japan Guest Researcher from the Port and Harbour Research Institute working at ERDC/WES, Vicksburg geotechnical research findings were transferred into USACE documents.
- Created a database comparing Japanese and US standard penetration tests to improve prediction of soil liquefaction.
- Influenced the creation of a NIST base isolation research program using data from translated Japan reports into English on base isolation systems.
- Increased awareness of wind engineering practice, problems, and breakthroughs in Japan and the U.S.
- Improved cross-discipline research among wind engineers/meteorologists/sociologists in each country.
- Increased the dissemination of latest research findings in wind engineering, especially post-storm events (typhoons/hurricanes) to each country.
- Stimulated interest to create Joint quick-response storm survey teams with interdisciplinary research thrusts to examine storm damage in both countries.
- Developed field test data for use in aerodynamic retrofit of bridge structures.
- Produced data that advanced retrofit techniques for bridge structures.
- Advanced technology for repairing and strengthening reinforced concrete, steel, and masonry structures, improved in-situ measurement methods for soil liquefaction and stability under seismic loads.
- Created database on storm surge and tsunamis and verified mathematical models of tsunami and storm surge warning systems.

- Established a library resource of current research on wind and earthquake engineering and on storm surge and tsunamis.
- Exchanged more than 250 guest researchers between Japan and the US that has resulted in advancing their respective organizations mission research, advanced the state-of-technology, and provided career growth opportunities for these guest researchers.
- Performed joint research in more than 10 collaborative research projects that resulted in new US seismic design criteria for buildings and bridges.
- Published proceedings of Panel meetings, Task Committee Workshops, and special publications such as List of Panel Publications, translated two-volume series on earthquake resistant construction using base isolation systems, newsletter, website of Panel activities, and more.
- Gained better knowledge of both countries research, design and construction capabilities from in-depth visits to host country's laboratories and building and public works projects. Results of such visits contribute to creation of new Task Committees, agendas for Joint Panel meetings and task committee workshops, special visits of US-Japan researchers, and joint collaborative research.

The Panel's efforts are exemplary of effective joint research and of technology delivery between researchers in the U.S. and Japan. Since its creation, about 2000 papers were presented in 40 Joint Panel Meetings and Task Committee Workshops and over 250 guest researchers were exchanged. The Panel provides important information about the U.S. and Japan's civil engineering thrusts which influence both countries' research and provide the basis for improvements in building and structure codes and standards.

TABLE OF CONTENTS

PREFACE	i
AGENDA OF JOINT MEETING AND TECHNICAL SITE VISITS	1
LIST OF PANEL MEMBERS	9
RESOLUTIONS	25
STRATEGIC PLAN	31
PAPERS	47
The Lessons of the Great East Japan Earthquake 2011 and the Countermeasures against Earthquakes and Tsunami in Future - Fundamental Concepts behind Future Tsunami Disaster Prevention -	
Shigeo Ochi* and Mao Suzuoki	49
Strong Motion and Earthquake Response Records of the 2011 off the Pacific Coast of Tohoku Earthquake	
Shojiro Kataoka*, Kazuhiro Nagaya, Kazunari Matsuoka and Masahiro Kaneko	61
Crustal Deformation and Fault Model of the 2011 off the Pacific Coast of Tohoku Earthquake	
Tetsuro Imakiire, Mikio Tobita, Shinzaburo Ozawa, Takuya Nishimura, Hisashi Suito and Tomokazu Kobayashi.....	70
Building Damage by the 2011 off the Pacific Coast of Tohoku Earthquake and Coping Activities by NILIM and BRI Collaborated with the Administration	
Isao Nishiyama*, Izuru Okawa*, Hiroshi Fukuyama* and Yasuo Okuda*	80
Effects on Dams due to the 2011 off the Pacific Coast of Tohoku Earthquake	
Yoshikazu Yamaguchi, Masafumi Kondo, Toshihide Kobori and Shinya Mitsuishi	139
U.S.-Japan Joint Reconnaissance Report of Bridge Damage due to 2011 Tohoku Earthquake	
Tetsuro Kuwabara* and Phillip Yen.....	152
Damage of Bridges during 2011 Great East Japan Earthquake	
Kazuhiro Kawashima*, Kenji Kosa, Yoshikazu Takahashi, Mitusuyoshi Akiyama, Tsutomu Nishioka, Gakuho Watanabe, Hirohisa Koga and Hiroshi Matsuzaki	165
Port Damage from Tsunami of the Great East Japan Earthquake	
Takashi Tomita*, Gyeong-Seon Yeom, Daisuke Tatsumi, Osamu Okamoto and Hiroyasu Kawai.....	179
ASCE/JSCE Tohoku Tsunami Investigation of Structural Damage and Development of the ASCE 7 Tsunami Design Code for Buildings and Other Structures	
Gary Chock*	184
The Impulsive Tsunami Source of the 2011 Off the Pacific Coast of Tohoku Earthquake Estimated from Seismic Wave and Offshore Tsunami Data	

Yutaka Hayashi, Hiroaki Tsushima, Yasuhiro Yoshida and Takashi Yokota	191
APPENDIX	201
TASK COMMITTEE REPORTS.....	203
CHARTER	217

**AGENDA OF JOINT MEETING AND
TECHNICAL SITE VISITS**

JOINT MEETING

August 28 (Sunday)

Arrival of U.S.-side Delegation

Hotel: Okura Frontier Hotel Tsukuba Epochal

Phone/Fax: +81-(0)29-860-7700/+81-(0)29-860-7701

<http://www.okura-tsukuba.co.jp/eng/>

August 29 (Monday)

9:30

Opening Ceremonies

[Int'l Conference Room]

Call to order by Keiichi Tamura, Secretary-General, Japan-side Panel

Remarks by Taketo Uomoto, Chairman, Japan-side Panel on Wind and Seismic Effects, Chief Executive, Public Works Research Institute

Remarks by Steven L. McCabe, Acting Chairman, U.S.-side Panel on Wind and Seismic Effects, Deputy Director, National Earthquake Hazards Reduction Program, Engineering Laboratory, National Institute of Standards and Technology, Department of Commerce

Introduction of Japan-side Members by Japan-side Panel Chairman

Introduction of U.S.-side Members by U.S.-side Panel Chairman

Elect Joint Panel Meeting Chairman

Adopt Agenda

Adjourn

10:10

Group Photograph

10:30

Technical Session 1 - The 2011 Great East Japan Earthquake

Chairman - Dr. Steven L. McCabe

10:30

The Lessons of the Great East Japan Earthquake 2011 and the Countermeasures against Earthquakes and Tsunami in Future - Fundamental Concepts behind Future Tsunami Disaster Prevention -, Shigeo Ochi* and Mao Suzuoki, Cabinet Office

10:50

Strong Motion and Earthquake Response Records of the 2011 off the Pacific Coast of Tohoku Earthquake, Shojiro Kataoka*, Kazuhiro Nagaya, Kazunari Matsuoka and

	Masahiro Kaneko, NILIM	
11:10	<i>U.S.-Japan Joint Reconnaissance Report of Bridge Damage due to 2011 Tohoku Earthquake</i> , Tetsuro Kuwabara*, PWRI; and Phillip Yen, FHWA	
11:30	<i>Damage of Bridges during 2011 Great East Japan Earthquake</i> , Kazuhiko Kawashima*, Tokyo Institute of Technology; Kenji Kosa, Kyusyu Institute of Technology; Yoshikazu Takahashi, Kyoto University; Mitsuoyoshi Akiyama, Waseda University; Tsutomu Nishioka, Hanshin Expressway, Co., Ltd.; Gakuho Watanabe, Yamaguchi University; Hirohisa Koga, PWRI; and Hiroshi Matsuzaki, Tokyo Institute of Technology	
11:50	Discussion	
12:10	Lunch	[1F Conference Room]
13:10	Technical Session 2 - The 2011 Great East Japan Earthquake Chairman - Dr. Steven L. McCabe	
13:10	<i>Building Damage by the 2011 off the Pacific Coast of Tohoku Earthquake and Coping Activities by NILIM and BRI Collaborated with the Administration - Outline</i> , Isao Nishiyama*, NILIM; <i>Building Damage due to Earthquake Ground Motion</i> , Hiroshi Fukuyama*, BRI; <i>Building Damage due to Tsunami</i> , Yasuo Okuda*, BRI; and <i>Regulation for Long-Period Earthquake Ground Motion</i> , Izuru Okawa*, BRI	
13:50	<i>US NSF/Japan BRI Tohoku Tsunami LiDAR Survey of Structures and Topography</i> , Solomon Yim*, OSU / <i>ASCE/JSCE Tohoku Tsunami Investigation of Structural Damage and Development of the ASCE 7 Tsunami Design Code for Buildings and Other Structures</i> , Gary Chock*, Martin & Chock, Inc.	
14:20	<i>Port Damage from Tsunami of the Great East Japan Earthquake</i> , Takashi Tomita*, Gyeong-Seon Yeom, Daisuke Tatsumi, Osamu Okamoto and Hiroyasu Kawai, PARI	
14:40	Discussion	
15:00	Break	
15:20	Task Committee Meetings	
	B: Buildings	[Room #610]
	C: Dams	[Room #616]
	D: Wind Engineering	[Room #727]
	G: Transportation Systems	[Room #617]
	H: Storm Surge and Tsunami	[Room #631]
17:00	Conclusion of Day 1	
18:30	Welcome Reception (Okura Frontier Hotel Tsukuba)	

August 30 (Tuesday)

- 9:00 **Strategic Planning Session 1**
 Chairman - Dr. Taketo Uomoto
- 10:20 Break
- 10:40 **Strategic Planning Session 2**
 Chairman - Dr. Taketo Uomoto
- 12:00 Lunch [1F Conference Room]
- 13:00 **Task Committee Reports**
 Chairman - Dr. Taketo Uomoto
- 14:20 Break
- 14:40 **Adoption of Final Resolutions**
 Chairman - Dr. Taketo Uomoto
- 16:00 Break
- 16:20 **Closing Ceremonies**
 Call to order by Keiichi Tamura, Secretary-General, Japan-side Panel
- Remarks by Steven L. McCabe, Acting Chairman, U.S.-side Panel on Wind and
 Seismic Effects
- Remarks by Taketo Uomoto, Chairman, Japan-side Panel on Wind and Seismic Effects
- 16:50 Conclusion of 43rd Joint Panel Technical Sessions

TECHNICAL SITE VISITS

Group 1 (Buildings)

August 31 (Wednesday)

8:47-9:40	Depart from Tsukuba for Akihabara by Tsukuba Express
10:28-12:16	Depart from Tokyo for Sendai by Hayate #163
12:30-13:30	Lunch
14:00-15:00	Visit Teraoka Elementary School
15:30-16:30	Visit Nankodai Junior High School
17:00-18:00	Visit Sendai 3rd Common Building for Governmental Offices
18:30	Arrive at Hotel

September 1 (Thursday)

8:30	Depart from hotel
9:00-11:00	Visit Tohoku University (Workshop)
11:30-12:00	Visit Furusato Building
12:00-13:00	Lunch
13:30-14:00	Visit 2nd Komatsujima Municipal Residential Housing
14:30-15:30	Visit Grand Jour Takasago-Ekimae
16:00-18:00	Visit Nagamachi Urban Residential Housing
18:30	Arrive at hotel

Group 2 (Dams)

August 31 (Wednesday)

8:00-11:00	Depart from Tsukuba by car
11:00-12:00	Visit Fujinuma Dam
12:30-13:30	Lunch
15:30-16:30	Visit Minamikawa Dam
17:30	Arrive at hotel

September 1 (Thursday)

8:00-10:30	Depart from hotel
10:30-12:00	Visit Ishibuchi Dam
12:30-13:30	Lunch
15:00-16:00	Visit Tase Dam
17:30	Arrive at hotel

Group 3 (Tsunami)**August 31 (Wednesday)**

8:47-9:40 Depart from Tsukuba for Akihabara by Tsukuba Express
10:28-12:16 Depart from Tokyo for Sendai by Hayate #163
12:30-13:30 Lunch
14:00-15:00 Visit Sendai Port
16:00-17:00 Visit Ishinomaki Port
18:30 Arrive at hotel

September 1 (Thursday)

7:30 Depart from hotel
10:00-10:30 Visit Kesenuma City
11:00-11:40 Visit Koizumi Bridge
11:50-12:30 Visit Sodeogawa Bridge
12:30-13:00 Lunch in the bus
13:00-13:30 Visit Nijyu-ichihama Bridge
13:45-14:25 Visit Utatsu Bridge
14:40-15:40 Visit Minami-Sanriku Town
16:40-17:10 Visit Onagawa Town
18:30 Arrive at hotel

September 2 (Friday)

8:30-10:15 Depart from Sendai for Tokyo by Hayate #152
11:03-11:57 Depart from Tokyo for Narita Airport (Terminal 1) by Narita Express #21
Departure of U.S.-side Delegation

LIST OF PANEL MEMBERS

U.S.-SIDE DELEGATION

Dr. Steven L. McCabe
Acting Chairman, U.S.-side Panel on Wind and Seismic Effects
Deputy Director, National Earthquake Hazards Reduction Program
Engineering Laboratory
National Institute of Standards and Technology
100 Bureau Drive, MS8630
Gaithersburg, MD 20899
301-975-8549
steven mccabe@nist.gov

Dr. Mehmet K. Celebi
Research Civil Engineer
U.S. Geological Survey
U.S. Department of the Interior
345 Middlefield Road, MS 977
Menlo Park, CA 94025
650-329-5623 (F) 650-329-5163
celebi@usgs.gov

Mr. Gary Y. K. Chock
President, Martin & Chock, Inc.
1132 Bishop Street, Suite 1550
Honolulu, HI 96813
808-521-4513
gchock@martinchock.com

Dr. Jeffrey J. Dragovich
Research Structural Engineer, National Earthquake Hazards Reduction Program
Engineering Laboratory
National Institute of Standards and Technology
100 Bureau Drive, Stop 8604
Gaithersburg, MD 20899-8604
301-975-6391
jeffrey.dragovich@nist.gov

Dr. Robert L. Hall
Chief, Geosciences and Structures Division
Geotechnical and Structures Laboratory
US Army Engineer Research and Development Center
CEERD-GS
3909 Halls Ferry Road
Vicksburg, MS 39180-6199
601-634-2567 (F) 601-634-3412
(C) 601-618-0644
Robert.L.Hall@erdc.usace.army.mil

Dr. James R. Harris
President, J. R. Harris & Company
1775 Sherman Street, Suite 2000
Denver, CO 80203
303-860-9021
Jim.Harris@jrharrisandco.com

Dr. Stephen A. Mahin

Director, Pacific Earthquake Engineering Research Center,
and Byron and Elvira Nishkian Professor of Structural Engineering
University of California at Berkeley
777 Davis Hall, University of California
Berkeley, CA, 94720-1710
510-693-6972
mahin@berkeley.edu

Dr. Joy Pauschke
Program Director, George E. Brown, Jr. Network for Earthquake Engineering Simulation (NEES)
Division of Civil, Mechanical, and Manufacturing Innovation
National Science Foundation
4201 Wilson Boulevard, Suite 545
Arlington, VA 22230
703-292-7024
jpauschk@nsf.gov

Dr. Long T. Phan
Research Structural Engineer, Materials and Construction Research Division
Engineering Laboratory
National Institute of Standards and Technology
100 Bureau Drive, Stop 8611
Gaithersburg, MD 20899-8611
301-975-6077
long.phan@nist.gov

Dr. Julio A. Ramirez
Professor of Civil Engineering and NEEScomm Center Director
School of Civil Engineering
Purdue University
550 Stadium Mall Drive
West Lafayette, IN 47907-2051
765-494-2716
ramirez@purdue.edu

Dr. David H. Sanders
Professor
Department of Civil and Environmental Engineering
University of Nevada
Reno, NV 89557
(T) 775-784-4288 (F) 775-784-1390
sanders@unr.edu

Dr. Solomon C. Yim
Professor
Structural and Ocean Engineering
Oregon State University
202 Apperson Hall
Corvallis, OR 97331-2302
541-737-6894 (F) 541-737-3052
solomon.yim@oregonstate.edu

U.S.-SIDE PANEL ON WIND AND SEISMIC EFFECTS MEMBERSHIP LIST

Dr. John R. Hayes, Jr. ("Jack")
Chairman, U.S.-side Panel on Wind and Seismic Effects
Director, National Earthquake Hazards Reduction Program
Engineering Laboratory
National Institute of Standards and Technology
100 Bureau Drive, MS8604
Gaithersburg, MD 20899
301-975-5640
jack.hayes@nist.gov

Dr. Marc L. Levitan
Secretary-General, U.S.-side Panel on Wind and Seismic
Effects
Leader, National Windstorm Impact Reduction Program
Research and Development
Engineering Laboratory
National Institute of Standards and Technology
100 Bureau Drive
Gaithersburg, MD 20899-8604
301-975-5340
marc.levitan@nist.gov

Mr. John Baals
Seismic Safety Coordinator
P.O. Box 25007 (D-8110)
Bureau of Reclamation
U.S. Department of the Interior
Denver, CO 80225
303-236-9129 x304 (F) 303-236-9099
jbaals@do.usbr.gov

Dr. Eddie N. Bernard
Director, Pacific Marine Environmental Laboratory
National Oceanic and Atmospheric Administration
U.S. Department of Commerce
7600 Sand Point Way, NE
BIN C15700/Building 3
Seattle, WA 98115-0070
206-526-6800 (F) 206-526-4576
Eddie.N.Bernard@noaa.gov

Dr. David M. Boore
U.S. Geological Survey
U.S. Department of the Interior
345 Middlefield Road MS 977
Menlo Park, CA 94025
650-329-5616 (F) 650-329-5163
boore@usgs.gov

Dr. Roger D. Borchardt
U.S. Geological Survey
U.S. Department of the Interior
345 Middlefield Road, MS 977
Menlo Park, CA 94025
650-329-5619 (F) 650-329-5163
borcherdt@usgs.gov

Mr. Stephen A. Cauffman
Deputy Chief, Materials and Structural Systems Division

Engineering Laboratory
National Institute of Standards and Technology
100 Bureau Drive, Stop 8611
Gaithersburg, MD 20899-8611
301-975-6051 (F) 301-869-6275
stephen.cauffman@nist.gov

Dr. Mehmet K. Celebi
Research Civil Engineer
U.S. Geological Survey
U.S. Department of the Interior
345 Middlefield Road, MS 977
Menlo Park, CA 94025
650-329-5623 (F) 650-329-5163
celebi@usgs.gov

Dr. C. Y. Chen
Senior Civil/Geotechnical Engineer
Office of Foreign Buildings
Department of State
Code SA-6, Rm. 347
Washington, DC 20520
703-875-6207 (F) 703-875-6204
chency@state.gov

Dr. Anjana Chudgar
Structural Engineer
U.S. Army Corps of Engineers
550 Main Street, RM 10-031
Cincinnati, OH 45202
513-684-6210 (F) 513-684-2460 (C) 5020345-0743
anjana.k.chudgar@hq02.usace.army.mil

Dr. Amr Elnashai
Director, Mid-America Earthquake Center
Professor of Civil Engineering
University of Illinois
1245 Newmark Laboratory
205 North Mathews Avenue
Urbana, IL 61801
217-265-5497 (F) 217-333-3821
aelnash@uiuc.edu

Mr. John Gaynor
Director, Office of Weather and Air Quality
Office of Oceanic and Atmospheric Research
National Oceanic and Atmospheric Administration
Silver Spring, MD 20910
301-734-1178 (F) 301-713-3515
john.gaynor@noaa.gov

Dr. Hamid Ghasemi
Bridge Safety, Reliability and Security
Office of Infrastructure and Security
Office of Infrastructure R&D
Federal Highway Administration
6300 Georgetown Pike
McLean VA 22101
202-493-3042 (F) 202-493-3443

hamid.ghasemi@fhwa.dot.gov

Dr. John L. Gross
Research Structural Engineer
Engineering Laboratory
National Institute of Standards and Technology
100 Bureau Drive, Stop 8611
Gaithersburg, MD 20899-8611
301-975-6068 (F) 301-869-6275
john.gross@nist.gov

Dr. Robert L. Hall
Chief, Geosciences and Structures Division
Geotechnical and Structures Laboratory
US Army Engineer Research and Development Center
CEERD-GS
3909 Halls Ferry Road
Vicksburg, MS 39180-6199
601-634-2567 (F) 601-634-3412
(C) 601-618-0644
Robert.L.Hall@erdc.usace.army.mil

Mr. R. Cris Hughes
Senior Civil Engineer, Dams Sector Branch
Office of Infrastructure Protection
U.S. Department of Homeland Security
245 Murray Lane, Arlington, VA 20598-0608
703-603-5121
cris.hughes@dhs.gov

Dr. Mary Ellen Hynes
Director of Research, Infrastructure, and Geophysical
Division
Science and Technology Directorate
Department of Homeland Security
Washington, DC 20528
1499 Massachusetts Avenue, NW Apt 113A, Washington,
DC 20005
202-254-5807
Maryellen.hynes@dhs.gov

Dr. Nicholas P. Jones
Dean, Whiting School of Engineering
Johns Hopkins University
Baltimore, MD 21218
410-516-4050 (Jeannie Pugh) 443-834-3740
npjones@jhu.edu

Mr. Michael D. Keever
Chief, Earthquake Engineering Office
California Department of Transportation Division of
Engineering Services, MS9-2/7J
P.O. Box 168041
Sacramento, CA 95816
916-227-8806 (F) 916-227-8242
mike_keeve@dot.ca.gov

Dr. George C. Lee
Task Director, Multidisciplinary Center for Earthquake
Engineering Research (MCEER)
University at Buffalo
122 Red Jacket Quad
Buffalo, NY 14261
716-645-3391 x111 (F) 716-645-3399
716-645-2039 716-310-1078 (C)
gcllee@mceermail.buffalo.edu

Mr. Eric Letvin
Director, Disaster and Failure Studies Program
Engineering Laboratory
National Institute of Standards and Technology
100 Bureau Drive, Stop 8611
Gaithersburg, MD 20899-8611
301-975-5412
eric.letvin@nist.gov

Dr. H. S. Lew
Senior Research Structural Engineer
Engineering Laboratory
National Institute of Standards and Technology
100 Bureau Drive, Stop 8611
Gaithersburg, MD 20899-8611
301-975-6060 (F) 301-869-6275
hai.lew@nist.gov

Dr. Nicolas Luco
Research Structural Engineer
Geologic Hazards Science Center
U. S. Geological Survey
U.S. Department of the Interior
1711 Illinois Street
Golden, CO 80401
303-273-8683
nluco@usgs.gov

Dr. Stephen A. Mahin
Director, Pacific Earthquake Engineering Research Center,
and Byron and Elvira Nishkian Professor of Structural
Engineering
University of California at Berkeley
777 Davis Hall, University of California
Berkeley, CA, 94720-1710
510-693-6972
mahin@berkeley.edu

Mr. Michael Mahoney
Physical Scientist
Federal Emergency Management Agency
500 C Street, SW
Washington, DC 20472
202-646-2794 (F) 202-646-4387
mike.mahoney@dhs.gov

Dr. Josephine N. Malilay
Associate Director for Science (Acting)
Division of Environmental Hazards and Health Effects
National Center for Environmental Health
Centers for Disease Control and Prevention
4770 Buford Hwy., NE (Mail stop F-52)
Atlanta, GA 30341
770-488-3465 (F) 770-488-3460
JMalilay@cdc.gov

Dr. Enrique E. Matheu
Chief, Dams Sector Branch
Sector Specific Agency Executive Management Office
Office of Infrastructure Protection
US Department of Homeland Security
Washington, DC 20528
703-235-2863 (F) 703-235-3053
enrique.matheu@dhs.gov

Dr. Steven L. McCabe
Deputy Director, National Earthquake Hazards Reduction
Program
Engineering Laboratory
National Institute of Standards and Technology
100 Bureau Drive, MS8630
Gaithersburg, MD 20899
301-975-8549
steven mccabe@nist.gov

Dr. Joy Pauschke
Program Director, George E. Brown, Jr. Network for
Earthquake Engineering Simulation (NEES)
Division of Civil, Mechanical, and Manufacturing
Innovation
National Science Foundation
4201 Wilson Boulevard, Suite 545
Arlington, VA 22230
703-292-7024
jpauschk@nsf.gov

Dr. Roger V. Pierce
Meteorologist, Office of Laboratories and Cooperative
Institutes
NOAA Office of Oceanic and Atmospheric Research
1315 East-West Highway SSMC3 room 11325
Silver Spring, MD 20910
301-734-1062
roger.pierce@noaa.gov

Mr. Noël J. Raufaste
NIST Emeritus/Guest Researcher
Engineering Laboratory
National Institute of Standards and Technology
Gaithersburg, MD 20899-8611
301-975-6062
noel.raufaste@nist.gov

Dr. Andrei M. Reinhorn
Clifford C. Furnas Professor of Structural Engineering and
Director, Structural Engineering and Earthquake
Simulation Laboratory (SEESL)
University at Buffalo, State University of New York
231 Ketter Hall, Buffalo, NY 14260
716-645-2114 X2419
(F) 716-645-3733
Reinhorn@buffalo.edu

Dr. William E. Roper
School of Computational Sciences
Center for Earth Observing and Space Research

George Mason University
4400 University Drive, MS 5C3
Fairfax, VA 22030
703-993-1648 (F) 703-993-1521
wroper@gmu.edu

Dr. Michael K. Sharp
Technical Director, Civil Works Infrastructure
Geotechnical and Structures Laboratory
US Army Engineer Research and Development Center
3909 Halls Ferry Road
Vicksburg, MS 39180-6199
601-634-4127 (F) 601-634-4894
michael.k.sharp@erdc.usace.army.mil

Dr. M. P. Singh
Program Director
Structural Systems and Hazard Mitigation of Structures
(SSHM)
Room 550 S
National Science Foundation
4201 Wilson Boulevard
Arlington, VA 22230
703-292-7081
mpsingh@nsf.gov

Dr. Charles E. Smith
Senior Technical Advisor
Accident Investigation Board
U. S. Minerals Management Service
381 Elden Street, MS 4021
Herndon, VA 20170-4817
703-787-1561 (F) 703-787-1549
smithe@mms.gov or Charles.E.Smith@mms.gov

Dr. W. Phillip Yen
Principal Bridge Engineer, Structural Dynamics
Office of Bridge Technology
Federal Highway Administration
1200 New Jersey Avenue, SE, Washington, DC 20590
202-493-3056 (F) 202-493-3442 (C) 202-468-6113
Wen-huei.Yen@dot.gov

Dr. Solomon C. Yim
Professor
Structural and Ocean Engineering
Oregon State University
202 Apperson Hall
Corvallis, OR 97331-2302
541-737-6894 (F) 541-737-3052
solomon.yim@oregonstate.edu

JAPAN-SIDE PANEL ON WIND AND SEISMIC EFFECTS

MEMBERSHIP LIST

STEERING COMMITTEE MEMBERS

Dr. Taketo Uomoto
Chairman, Japan-side Panel on Wind and Seismic Effects
Chief Executive, Public Works Research Institute
1-6 Minamihara, Tsukuba-shi, Ibaraki-ken 305-8516
Tel: 029-879-6700
Fax: 029-879-6702
E-mail: uomoto@pwri.go.jp

Dr. Keiichi Tamura
Secretary-General, Japan-side Panel on Wind and Seismic Effects
Research Coordinator for Earthquake Engineering
Center for Advanced Engineering Structural Assessment and Research (CAESAR)
Public Works Research Institute
1-6 Minamihara, Tsukuba-shi, Ibaraki-ken 305-8516
Tel: 029-879-6721
Fax: 029-879-6739
E-mail: ke-tamura@pwri.go.jp

Dr. Tomonori Abe
Director, Hydraulic Engineering Research Group
Public Works Research Institute
1-6 Minamihara, Tsukuba-shi, Ibaraki-ken 305-8516
Tel: 029-879-6723
Fax: 029-879-6737
E-mail: to-abe@pwri.go.jp

Mr. Yoshikazu Fukushima
Director, Geocartographic Department
Geospatial Information Authority of Japan
Ministry of Land, Infrastructure, Transport and Tourism
1 Kitasato, Tsukuba-shi, Ibaraki-ken 305-0811
Tel: 029-864-2667
Fax: 029-864-1804
E-mail: fukushima@gsi.go.jp

Dr. Hiroshi Fukuyama
Chief Research Engineer, Department of Structural Engineering
Building Research Institute
1 Tachihara, Tsukuba-shi, Ibaraki-ken 305-0802
Tel: 029-864-6647
Fax: 029-864-6773
E-mail: fukuyama@kenken.go.jp

Mr. Tomohiro Hasegawa
Director for International Building Analysis, Building Guidance Division
Housing Bureau
Ministry of Land, Infrastructure, Transport and Tourism
2-1-3 Kasumigaseki, Chiyoda-ku, Tokyo 100-8918
Tel: 03-5253-8111
Fax: 03-5253-1630
E-mail: hasegawa-t2qq@mlit.go.jp

Dr. Jun-ichi Hoshikuma
Chief Researcher, Bridge and Structural Engineering Research Group
Center for Advanced Engineering Structural Assessment and Research (CAESAR)
Public Works Research Institute
1-6 Minamihara, Tsukuba-shi, Ibaraki-ken 305-8516
Tel: 029-879-6773
Fax: 029-879-6739
E-mail: hosikuma@pwri.go.jp

Dr. Masanori Iiba
Director, Department of Structural Engineering
Building Research Institute
1 Tachihara, Tsukuba-shi, Ibaraki-ken 305-0802
Tel: 029-864-6633
Fax: 029-864-6773
E-mail: iiba-m@kenken.go.jp

Dr. Koichi Kajiwara
Director, Hyogo Earthquake Engineering Center
National Research Institute for Earth Science and Disaster Prevention
1501-21, Mitsuta, Nishikameya, Shijimi-cho, Miki-shi, Hyogo-ken 673-0515
Tel: 0794-85-8944
Fax: 0794-85-7994
E-mail: kaji@bosai.go.jp

Mr. Masahiro Kaneko
Head, Earthquake Disaster Prevention Division
Research Center for Disaster Risk Management
National Institute for Land and Infrastructure Management
Ministry of Land, Infrastructure, Transport and Tourism
1 Asahi, Tsukuba-shi, Ibaraki-ken 305-0804
Tel: 029-864-3244
Fax: 029-864-0598
E-mail: kaneko-m92pq@nilim.go.jp

Dr. Kazuhiko Kawashima
Professor, Department of Civil Engineering
Tokyo Institute of Technology
2-12-1 O-okayama, Meguro-ku, Tokyo 152-8552
Tel: 03-5734-2922
Fax: 03-5734-3810
E-mail: kawashima k.ae@m.titech.ac.jp

Dr. Shin Koyama
Chief Research Engineer, Department of Structural Engineering
Building Research Institute
1 Tachihara, Tsukuba-shi, Ibaraki-ken 305-0802
Tel: 029-864-6761
Fax: 029-864-6773
E-mail: skoyama@kenken.go.jp

Mr. Tetsuro Kuwabara
Director, Bridge and Structural Engineering Research
Group
Center for Advanced Engineering Structural Assessment
and Research (CAESAR)
Public Works Research Institute
1-6 Minamihara, Tsukuba-shi, Ibaraki-ken 305-8516
Tel: 029-879-6726
Fax: 029-879-6739
E-mail: t-kuwa@pwri.go.jp

Mr. Rikio Minamiyama
Director, Office of Reduction Research
Research and Development Bureau
Ministry of Education, Culture, Sports, Science and
Technology
3-2-2 Kasumigaseki, Chiyoda-ku, Tokyo 100-8959
Tel: 03-6734-4134
Fax: 03-6734-4139
E-mail: rminami@mext.go.jp

Dr. Shuzo Murakami
Chief Executive, Building Research Institute
1 Tachihara, Tsukuba-shi, Ibaraki-ken 305-0802
Tel: 029-864-2900
Fax: 029-864-3574
E-mail: murakami@kenken.go.jp

Mr. Jun Murakoshi
Chief Researcher, Bridge and Structural Engineering
Research Group
Center for Advanced Engineering Structural Assessment
and Research (CAESAR)
Public Works Research Institute
1-6 Minamihara, Tsukuba-shi, Ibaraki-ken 305-8516
Tel: 029-879-6792
Fax: 029-879-6739
E-mail: murakosi@pwri.go.jp

Dr. Masaomi Nakamura
Director, Typhoon Research Department
Meteorological Research Institute
Japan Meteorological Agency
1-1 Nagamine, Tsukuba-shi, Ibaraki-ken 305-0052
Tel: 029-853-8663
Fax: 029-853-8735
E-mail: manakamu@mri-jma.go.jp

Mr. Kazuhiro Nishikawa
Director-General
National Institute for Land and Infrastructure Management
Ministry of Land, Infrastructure, Transport and Tourism
1 Asahi, Tsukuba-shi, Ibaraki-ken 305-0804
Tel: 029-864-2210
Fax: 029-864-2148
E-mail: nishikawa-k92br@nilim.go.jp

Dr. Isao Nishiyama
Director, Building Department
National Institute for Land and Infrastructure Management
Ministry of Land, Infrastructure, Transport and Tourism
1 Tachihara, Tsukuba-shi, Ibaraki-ken 305-0802
Tel: 029-864-4277
Fax: 029-864-6774
E-mail: nishiyama-i92ta@nilim.go.jp

Mr. Tomofumi Nozaki
Director, Road Risk Management Office, National
Highway and Risk Management Division
Road Bureau
Ministry of Land, Infrastructure, Transport and Tourism
2-1-3 Kasumigaseki, Chiyoda-ku, Tokyo 100-8918
Tel: 03-5253-8111
Fax: 03-5253-1620
E-mail: nozaki-t2td@mlit.go.jp

Mr. Shigeo Ochi
Director for Earthquake, Volcanic and Large-scale Flood
Disaster Management
Disaster Management Bureau
Cabinet Office
1-2-2 Kasumigaseki, Chiyoda-ku, Tokyo 100-8969
Tel: 03-3501-5693
Fax: 03-3501-5199
E-mail: shigeo.ochi@cao.go.jp

Dr. Hisashi Okada
Director, Testing and Research Laboratory
Japan Housing and Wood Technology Center
3-4-2 Shinsuna, Koto-ku, Tokyo 136-0075
Tel: 03-3647-3930
Fax: 03-3647-3840
E-mail: h-okada@howtec.or.jp

Dr. Michio Okahara
President, Advanced Construction Technology Center
2-15-6 Otsuka, Bunkyo-ku, Tokyo 112-0012
Tel: 03-3942-3990
Fax: 03-3942-0424
E-mail: okahara@actec.or.jp

Dr. Izuru Okawa
Senior Research Fellow, Department of Structural
Engineering
Building Research Institute
1 Tachihara, Tsukuba-shi, Ibaraki-ken 305-0802
Tel: 029-864-6627
Fax: 029-864-6773
E-mail: okawa@kenken.go.jp

Dr. Yasuo Okuda
Chief Research Engineer, Department of Structural
Engineering
Building Research Institute
1 Tachihara, Tsukuba-shi, Ibaraki-ken 305-0802
Tel: 029-864-6618
Fax: 029-864-6773
E-mail: y_okuda@kenken.go.jp

Dr. Taiki Saito
Chief Research Engineer, International Institute of
Seismology and Earthquake Engineering
Building Research Institute
1 Tachihara, Tsukuba-shi, Ibaraki-ken 305-0802
Tel: 029-864-6751
Fax: 029-864-6777
E-mail: tsaito@kenken.go.jp

Mr. Tetsuya Sasaki
Team Leader, Soil Mechanics and Dynamics Research
Team
Geology and Geotechnical Engineering Research Group

Public Works Research Institute
1-6 Minamihara, Tsukuba-shi, Ibaraki-ken 305-8516
Tel: 029-879-6770
Fax: 029-879-6735
E-mail: t-sasaki@pwri.go.jp

Dr. Hiroshi Sato
Counselor, IHI Infrastructure Systems Co., Ltd.
3 Ohama-nishimachi, Sakai-ku, Sakai-shi, Osaka 590-0977
Tel: 072-223-0980
Fax: 072-223-0854
E-mail: hiroshi_sato@iis.ihl.co.jp

Mr. Hiroshi Satoda
Senior Coordinator for Research and Development,
Planning Division, Administration Department
Japan Meteorological Agency
1-3-4 Ote-machi, Chiyoda-ku, Tokyo 100-8122
Tel: 03-3212-8341
Fax: 03-3211-2032
E-mail: satoda@met.kishou.go.jp

Dr. Koji Sekiguchi
Head, Outreach Group
Outreach and International Research Promotion Center
National Research Institute for Earth Science and Disaster
Prevention
3-1 Tennodai, Tsukuba-shi, Ibaraki-ken 305-0006
Tel: 029-863-7784
Fax: 029-851-1622
E-mail: ksekigut@bosai.go.jp

Dr. Hideki Sugita
Geology and Geotechnical Engineering Research Group
Public Works Research Institute
1-6 Minamihara, Tsukuba-shi, Ibaraki-ken 305-8516
Tel: 029-879-6814
Fax: 029-879-6735
E-mail: sugita@pwri.go.jp

Mr. Tetsutaro Sumi
Director, Disaster Risk Management Office, Disaster
Prevention and Relief Division
Water and Disaster Management Bureau
Ministry of Land, Infrastructure, Transport and Tourism
2-1-3 Kasumigaseki, Chiyoda-ku, Tokyo 100-8918
Tel: 03-5253-8111
Fax: 03-5253-1608
E-mail: sumi-t2k3@mlit.go.jp

Mr. Morito Takahashi
Director, Cold-Region Construction Engineering Research
Group
Civil Engineering Research Institute for Cold Region
Public Works Research Institute
1-3-1-34 Hiragishi, Toyohira-ku, Sapporo-shi, Hokkaido
062-8602
Tel: 011-841-5175
Fax: 011-841-3502
E-mail: morito@ceri.go.jp

Mr. Naokazu Takata
Director, Disaster Risk Management Office
Coastal Administration and Disaster Management Division
Ports and Harbors Bureau

Ministry of Land, Infrastructure, Transport and Tourism
2-1-3 Kasumigaseki, Chiyoda-ku, Tokyo 100-8918
Tel: 03-5253-8111
Fax: 03-5253-1654
E-mail: takata-n2fw@mlit.go.jp

Dr. Takashi Tomita
Tsunami Research Director, Asia-Pacific Center for Coastal
Disaster Research
Port and Airport Research Institute
3-1-1 Nagase, Yokosuka-shi, Kanagawa-ken 239-0826
Tel: 046-844-5052
Fax: 046-844-1274
E-mail: tomita@pari.go.jp

Dr. Shigeki Unjoh
Research Coordinator for Earthquake Disaster Prevention,
Research Center for Disaster Risk Management
National Institute for Land and Infrastructure Management
Ministry of Land, Infrastructure, Transport and Tourism
1 Asahi, Tsukuba-shi, Ibaraki-ken 305-0804
Tel: 029-864-4963
Fax: 029-864-0598
E-mail: unjoh-s92ta@nilim.go.jp

Dr. Yoshikazu Yamaguchi
Team Leader, Dam and Appurtenant Structure Research
Team
Hydraulic Engineering Research Group
Public Works Research Institute
1-6 Minamihara, Tsukuba-shi, Ibaraki-ken 305-8516
Tel: 029-879-6780
Fax: 029-879-6737
E-mail: yamaguti@pwri.go.jp

Mr. Naoyuki Yamane
Director, Planning and Research Administration
Department
National Institute for Land and Infrastructure Management
Ministry of Land, Infrastructure, Transport and Tourism
1 Asahi, Tsukuba-shi, Ibaraki-ken 305-0804
Tel: 029-864-2826
Fax: 029-864-1527
E-mail: yamane-n8310@nilim.go.jp

Mr. Goro Yasuda
Director, International Cooperation and Engineering for
Infrastructure, Overseas Project Division
Policy Bureau
Ministry of Land, Infrastructure, Transport and Tourism
2-1-3 Kasumigaseki, Chiyoda-ku, Tokyo 100-8918
Tel: 03-5253-8111
Fax: 03-5253-1562
E-mail: yasuda-g252@mlit.go.jp

Dr. Takashi Yokota
Director, Seismology and Volcanology Research
Department
Meteorological Research Institute
Japan Meteorological Agency
1-1 Nagamine, Tsukuba-shi, Ibaraki-ken 305-0052
Tel: 029-853-8675
Fax: 029-851-3730
E-mail: yokotat@met.kishou.go.jp

SECRETARIES COMMITTEE MEMBERS

Dr. Keiichi Tamura
Secretary-General, Japan-side Panel on Wind and Seismic Effects
Research Coordinator for Earthquake Engineering
Center for Advanced Engineering Structural Assessment and Research (CAESAR)
Public Works Research Institute
1-6 Minamihara, Tsukuba-shi, Ibaraki-ken 305-8516
Tel: 029-879-6721
Fax: 029-879-6739
E-mail: ke-tamura@pwri.go.jp

Mr. Tatsuya Azuhata
Head, Structural Standard Division
Building Department
National Institute for Land and Infrastructure Management
Ministry of Land, Infrastructure, Transport and Tourism
1 Tachihara, Tsukuba-shi, Ibaraki-ken 305-0802
Tel: 029-864-4307
Fax: 029-864-6774
E-mail: azuhata-t92ta@nilim.go.jp

Dr. Hiroshi Fukuyama
Chief Research Engineer, Department of Structural Engineering
Building Research Institute
1 Tachihara, Tsukuba-shi, Ibaraki-ken 305-0802
Tel: 029-864-6647
Fax: 029-864-6773
E-mail: fukuyama@kenken.go.jp

Dr. Jun-ichi Hoshikuma
Chief Researcher, Bridge and Structural Engineering Research Group
Center for Advanced Engineering Structural Assessment and Research (CAESAR)
Public Works Research Institute
1-6 Minamihara, Tsukuba-shi, Ibaraki-ken 305-8516
Tel: 029-879-6773
Fax: 029-879-6739
E-mail: hosikuma@pwri.go.jp

Mr. Masahiro Kaneko
Head, Earthquake Disaster Prevention Division
Research Center for Disaster Risk Management
National Institute for Land and Infrastructure Management
Ministry of Land, Infrastructure, Transport and Tourism
1 Asahi, Tsukuba-shi, Ibaraki-ken 305-0804
Tel: 029-864-3244
Fax: 029-864-0598
E-mail: kaneko-m92pq@nilim.go.jp

Mr. Tetsuro Kuwabara
Director, Bridge and Structural Engineering Research Group
Center for Advanced Engineering Structural Assessment and Research (CAESAR)
Public Works Research Institute
1-6 Minamihara, Tsukuba-shi, Ibaraki-ken 305-8516
Tel: 029-879-6726
Fax: 029-879-6739
E-mail: t-kuwa@pwri.go.jp

Dr. Koichi Morita
Chief Research Engineer, International Institute of Seismology and Earthquake Engineering
Building Research Institute
1 Tachihara, Tsukuba-shi, Ibaraki-ken 305-0802
Tel: 029-864-6677
Fax: 029-864-6777
E-mail: morita@kenken.go.jp

Mr. Jun Murakoshi
Chief Researcher, Bridge and Structural Engineering Research Group
Center for Advanced Engineering Structural Assessment and Research (CAESAR)
Public Works Research Institute
1-6 Minamihara, Tsukuba-shi, Ibaraki-ken 305-8516
Tel: 029-879-6792
Fax: 029-879-6739
E-mail: murakosi@pwri.go.jp

Mr. Hidetoshi Nakajima
Head, Planning Division, Geocartographic Department
Geospatial Information Authority of Japan
Ministry of Land, Infrastructure, Transport and Tourism
1 Kitasato, Tsukuba-shi, Ibaraki-ken 305-0811
Tel: 029-864-5917
Fax: 029-864-1804
E-mail: nakajima@gsi.go.jp

Dr. Shoichi Nakatani
Chief Researcher, Bridge and Structural Engineering Research Group
Center for Advanced Engineering Structural Assessment and Research (CAESAR)
Public Works Research Institute
1-6 Minamihara, Tsukuba-shi, Ibaraki-ken 305-8516
Tel: 029-879-6794
Fax: 029-879-6739
E-mail: nakatani@pwri.go.jp

Dr. Hiroaki Nishi
Team Leader, Structures Research Team
Cold-Region Construction Engineering Research Group
Civil Engineering Research Institute for Cold Region
Public Works Research Institute
1-3-1-34 Hiragishi, Toyohira-ku, Sapporo-shi, Hokkaido
062-8602
Tel: 011-841-1698
Fax: 011-841-3502
E-mail: h-nishi@ceri.go.jp

Dr. Yasuo Okuda
Chief Research Engineer, Department of Structural Engineering
Building Research Institute
1 Tachihara, Tsukuba-shi, Ibaraki-ken 305-0802
Tel: 029-864-6618
Fax: 029-864-6773
E-mail: y_okuda@kenken.go.jp

Mr. Tetsuya Sasaki

Team Leader, Soil Mechanics and Dynamics Research
Team
Geology and Geotechnical Engineering Research Group
Public Works Research Institute
1-6 Minamihara, Tsukuba-shi, Ibaraki-ken 305-8516
Tel: 029-879-6770
Fax: 029-879-6735
E-mail: t-sasaki@pwri.go.jp

Dr. Koji Sekiguchi
Head, Outreach Group
Outreach and International Research Promotion Center
National Research Institute for Earth Science and Disaster
Prevention
3-1 Tennodai, Tsukuba-shi, Ibaraki-ken 305-0006
Tel: 029-863-7784
Fax: 029-851-1622
E-mail: ksekigut@bosai.go.jp

Dr. Hideki Sugita
Geology and Geotechnical Engineering Research Group
Public Works Research Institute
1-6 Minamihara, Tsukuba-shi, Ibaraki-ken 305-8516
Tel: 029-879-6814
Fax: 029-879-6735
E-mail: sugita@pwri.go.jp

Mr. Osamu Suzuki
Head, The Second Research Laboratory
Meteorological Satellite and Observation System Research
Department
Meteorological Research Institute
Japan Meteorological Agency

1-1 Nagamine, Tsukuba-shi, Ibaraki-ken 305-0052
Tel: 029-853-8578
Fax: 029-853-0644
E-mail: osuzuki@mri-jma.go.jp

Dr. Takashi Tomita
Tsunami Research Director, Asia-Pacific Center for Coastal
Disaster Research
Port and Airport Research Institute
3-1-1 Nagase, Yokosuka-shi, Kanagawa-ken 239-0826
Tel: 046-844-5052
Fax: 046-844-1274
E-mail: tomita@pari.go.jp

Dr. Shigeki Unjoh
Research Coordinator for Earthquake Disaster Prevention,
Research Center for Disaster Risk Management
National Institute for Land and Infrastructure Management
Ministry of Land, Infrastructure, Transport and Tourism
1 Asahi, Tsukuba-shi, Ibaraki-ken 305-0804
Tel: 029-864-4963
Fax: 029-864-0598
E-mail: unjoh-s92ta@nilim.go.jp

Dr. Yoshikazu Yamaguchi
Team Leader, Dam and Appurtenant Structure Research
Team
Hydraulic Engineering Research Group
Public Works Research Institute
1-6 Minamihara, Tsukuba-shi, Ibaraki-ken 305-8516
Tel: 029-879-6780
Fax: 029-879-6737
E-mail: yamaguti@pwri.go.jp

TEMPORARY MEMBERS

Mr. Yutaka Hayashi	Meteorological Research Institute
Mr. Tetsuro Imakiire	Geospatial Information Authority of Japan
Dr. Shojiro Kataoka	National Institute for Land and Infrastructure Management

ASSOCIATE MEMBERS

Mr. Tomomitsu Fujii	Foundation of River Basin Integrated Communications
Dr. Minoru Fujiwara	Formerly, Nippon Slag Association
Dr. Masami Fukuoka	Management System Assessment Center
Dr. Masaya Hirosawa	Professor Emeritus, Kogakuin University
Dr. Shiro Ibukiyama	Professor Emeritus, Kogyokusha College of Technology
Dr. Kaoru Ichihara	Public Works Research Center
Dr. Takashi Iijima	Civil Engineering Research Laboratory
Mr. Yasutake Inoue	Fukuda Corporation
Dr. Toshio Iwasaki	Public Works Research Center
Mr. Shunichiro Kamijo	KICTEC Inc.
Mr. Kenji Kawakami	Kubota Corporation
Dr. Kazuhiko Kawashima	Professor, Tokyo Institute of Technology
Dr. Eiichi Kuribayashi	Professor Emeritus, Toyohashi University of Technology
Dr. Kiyoshi Nakano	Professor Emeritus, Tokyo Denki University
Dr. Shinsuke Nakata	Professor, Kochi University of Technology
Dr. Kazuto Nakazawa	Formerly, Public Works Research Institute
Dr. Nobuyuki Narita	Public Works Research Center
Dr. Setsuo Noda	Coastal Development Institute of Technology
Dr. Hisashi Okada	Japan Housing and Wood Technology Center
Dr. Michio Okahara	Advanced Construction Technology Center
Dr. Shin Okamoto	Japan Association for Building Research Promotion
Mr. Kei-ichi Ohtani	Formerly, National Research Institute for Earth Science and Disaster Prevention
Mr. Yoshijiro Sakagami	Formerly, Japan Development Construction Corporation
Dr. Tadahiko Sakamoto	Nippon Koei Co., Ltd.
Dr. Yasushi Sasaki	Japan Institute of Construction Engineering
Dr. Hiroshi Sato	IHI Infrastructure Systems Co., Ltd.
Dr. Yukihiko Sumiyoshi	Central Consultant Inc.
Mr. Jiro Taguchi	Sakurada Co., Ltd.
Dr. Masateru Tominaga	Public Works Research Center, Central Consultant Inc.
Dr. Hajime Tsuchida	Japan Association of Cargo-handling Machinery Systems
Mr. Seizo Tsuji	Japan Utility Subway Company Inc.
Dr. Hiroyuki Yamanouchi	The Building and Housing Center of Japan, Inc.
Dr. Koichi Yokoyama	Professor Emeritus, Ibaraki University

TASK COMMITTEE MEMBERS

* denotes Task Committee Chair.

B. Buildings

John R. Hayes*	NIST
Fu-Kuo Chang	Stanford University
Douglas Foutch	NSF
George C. Lee	MCEER
Steven L. McCabe	NIST
Mete A. Sozen	Purdue University
B. F. Spencer	University of Illinois
K. Thirumalai	DOT
Ming Wang	University of Illinois
Isao Nishiyama*	National Institute for Land and Infrastructure Management
Hiroshi Fukuyama*	Building Research Institute
Tatsuya Azuhata	National Institute for Land and Infrastructure Management
Takashi Hasegawa	Building Research Institute
Namihiko Inoue	National Institute for Land and Infrastructure Management
Tadasi Ishihara	Building Research Institute
Yoshihiro Iwata	National Institute for Land and Infrastructure Management
Toshikazu Kabeyasawa	Building Research Institute
Koichi Kajiwara	National Research Institute for Earth Science and Disaster Prevention
Hiroto Kato	Building Research Institute
Hitomitsu Kikitsu	National Institute for Land and Infrastructure Management
Koichi Kusunoki	Yokohama National University
Koichi Morita	Building Research Institute
Akiyoshi Mukai	National Institute for Land and Infrastructure Management
Tomohisa Mukai	Building Research Institute
Taiki Saito	Building Research Institute
Hitoshi Shiohara	University of Tokyo
Haruhiko Suwada	National Institute for Land and Infrastructure Management
Seitarou Tajiri	Building Research Institute
Masanori Tani	Building Research Institute
Masaomi Teshigawara	Nagoya University

C. Dams

Enrique E. Matheu*	DHS
Michael K. Sharp*	USACE-ERDC
Anjuna Chudgar	USACE
Richard C. Dove	USACE-ERDC
Ziyad H. Duron	Harvey Mudd College
Robert L. Hall	USACE-ERDC
Larry K. Nuss	U.S. Bureau of Reclamation
Richard S. Olsen	USACE-ERDC
Rick Poeppelman	USACE
Donald E. Yule	USACE-ERDC
Yoshikazu Yamaguchi*	Public Works Research Institute
Tomonori Abe	Public Works Research Institute
Noriaki Hakoishi	Public Works Research Institute
Takashi Ikeda	Japan Dam Engineering Center
Kuninobu Itoh	Japan Water Agency
Hideaki Kawasaki	Yamaguchi University
Masafumi Kondo	Public Works Research Institute
Hiroyuki Satoh	Public Works Research Institute
Nario Yasuda	Kyoto University

D. Wind Engineering

Marc L. Levitan*	NIST
------------------	------

Earl J. Baker	Florida State University
Bogusz Bienkiewicz	Colorado State University
Harold Bosch	FHWA
Donald Burgess	NOAA
John Gaynor	NOAA
Nicholas P. Jones	Johns Hopkins University
Ahsan Kareem	University of Notre Dame
Joseph Main	NIST
Mark D. Powell	NOAA
Liz Ritchie	University of New Mexico
Partha Sarkar	Iowa State University
Emil Simiu	NIST

Yasuo Okuda*	Building Research Institute
Hitoshi Yamada*	Yokohama National University
Susumu Fukunaga	Honshu-Shikoku Bridge Expressway Company Limited
Takeshi Ishihara	University of Tokyo
Hiroshi Katsuchi	Yokohama National University
Hiromasa Kawai	Kyoto University
Hitomitsu Kikitsu	National Institute for Land and Infrastructure Management
Kichiro Kimura	Tokyo University of Science
Masao Mikami	Meteorological Research Institute
Jun Murakoshi	Public Works Research Institute
Masaomi Nakamura	Meteorological Research Institute
Hisashi Okada	Japan Housing and Wood Technology Center
Hiromichi Shirato	Kyoto University
Tetsuro Tamura	Tokyo Institute of Technology
Yukio Tamura	Tokyo Institute of Polytechnics
Yasushi Uematsu	Tohoku University

G. Transportation Systems

W. Phillip Yen*	FHWA
Harold Bosch	FHWA
Michel Bruneau	MCEER
Peter Chang	University of Maryland
Hamid Ghasemi	FHWA
Nicholas P. Jones	Johns Hopkins University
David H. Sanders	University of Nevada

Tetsuro Kuwabara*	Public Works Research Institute
Yozo Fujino	University of Tokyo
Taku Hanai	Public Works Research Institute
Jun-ichi Hoshikuma	Public Works Research Institute
Satoshi Kashima	Japan Bridge Engineering Center
Minoru Kawaida	Central Nippon Expressway Company Limited
Kazuhiko Kawashima	Tokyo Institute of Technology
Motoki Kazama	Tohoku University
Kenji Kosa	Kyushu Institute of Technology
Jun Murakoshi	Public Works Research Institute
Shoichi Nakatani	Public Works Research Institute
Takashi Negi	National Institute for Land and Infrastructure Management
Hiroaki Nishi	Public Works Research Institute
Hideaki Nishida	Public Works Research Institute
Atsushi Nozu	Port and Airport Research Institute
Katsuya Ogihara	Honshu-Shikoku Bridge Expressway Company Limited
Masasumi Okada	Metropolitan Expressway Company Limited
Hiroshi Sato	IHI Infrastructure Systems Company Limited
Takahiro Sugano	Port and Airport Research Institute
Akiko Tabata	Hanshin Expressway Company Limited
Shunsuke Tanimoto	Public Works Research Institute
Takashi Tamakoshi	National Institute for Land and Infrastructure Management
Keiichi Tamura	Public Works Research Institute
Shigeki Unjoh	National Institute for Land and Infrastructure Management
Hiroshi Watanabe	Public Works Research Institute

H. Storm Surge and Tsunami

Solomon C. Yim*	OSU
Eddie Bernard	NOAA
Michael Briggs	USACE
Gary Y. K. Chock	Martin & Chock, Inc.
Laura Kong	ITIC
Marc L. Levitan	NIST
Long T. Phan	NIST
Harry Yeh	OSU
Philip Liu	Cornell University
Takashi Tomita*	Port and Airport Research Institute
Koji Fujima	National Defense Academy of Japan
Kenji Hirata	Meteorological Research Institute
Fumihiko Imamura	Tohoku University
Hiroyasu Kawai	Port and Airport Research Institute
Nadao Kohno	Japan Meteorological Agency
Norimi Mizutani	Nagoya University
Takashi Negi	National Institute for Land and Infrastructure Management
Yoshio Suwa	National Institute for Land and Infrastructure Management

RESOLUTIONS

**RESOLUTIONS OF THE FORTY-THIRD JOINT MEETING
U.S.-JAPAN PANEL ON WIND AND SEISMIC EFFECTS (UJNR)**

National Institute for Land and Infrastructure Management, Tsukuba, Japan
29-30 August 2011

The following resolutions are hereby adopted:

1. The Forty-Third Joint Panel Meeting provided the forum to exchange valuable technical information that is beneficial to both countries. In particular, both sides shared information on the 2011 Great East Japan Earthquake and its impacts on buildings and infrastructure. The Panel discussed and drafted its tentative Third Five-Year Strategic Plan. In view of the importance of cooperative programs on the subject of wind and seismic effects, the continuation of Joint Panel Meetings is considered important. Both sides agreed to follow the recommendations of the Panel's Third Five-Year Strategic Plan after it is reviewed and adopted by both sides and will emphasize identifying opportunities, primarily through its Task Committees, for sharing and developing technologies that lead to new design and construction practices, and for providing users with improved design and construction procedures.
2. The following activities have been conducted since the Forty-Second Joint Meeting:
 - a. Technology Exchanges. Technical experts and technical documents have been exchanged. These exchanges have contributed to the development of new research and enhanced ongoing research programs in both countries.
 - b. Major Products. The Panel members produced or made significant contributions to advancing the Panel's mission:
 - 1) Task Committee C continued to conduct collaborative research on non-linear response analysis and discrete element method analysis of concrete dams.
 - 2) Task Committee H members contributed to conducting experimental research and developing various numerical models to simulate tsunamis in coastal areas.
 - c. The Panel members contributed to various reconnaissance efforts following the 2011 Great East Japan Earthquake.
 - 1) Japanese and the U.S. members of Task Committee G performed a joint investigation on highway bridge damage due to the 2011 Great East Japan Earthquake and ensuing tsunami.
 - 2) The Japan-side Task Committee H members supported the tsunami damage investigation by the ASCE's field reconnaissance survey team including the U.S.-side Chair of Task Committee H.
 - 3) The Japan-side Task Committee G members supported the investigation on transportation systems by the ASCE Technical Council on Lifeline Earthquake Engineering.
 - 4) The Japan-side Panel members conducted joint surveys and exchanged

information with the U.S. tsunami research teams supported by NSF and ASCE.

3. The Panel accepted the Task Committee reports presented during the Forty-Third Joint Panel Meeting. Each report included objectives, scope of work, accomplishments and future plans. Those reports are provided in a separate document.
4. The Panel conducted its annual Strategic Planning Session. During this session the Panel discussed and drafted its Third Five-Year Strategic Plan. The Panel evaluated its accomplishments and Task Committees activities and made future recommendations. The following are the highlights.
 - a. The draft Third Five-Year Strategic Plan will be reviewed by both sides and finalized by the end of 2011 through the coordination by the Secretaries-General of both sides and approval by the Panel Chairmen.
 - b. The Panel approved the reactivation of Task Committee A (Strong Motions and Effects) whose operating charter was submitted at the Forty-Third Joint Panel Meeting and met the criteria described in the Strategic Plan.
 - c. The Panel created a Panel logo.
 - d. The Panel continues to work toward streamlining its structure, encouraging and expanding the collaboration of researchers in both countries.
 - e. The results of the Panel's work should be widely disseminated to improve the quality of life globally. The Panel encourages greater use of e-mail, the Panel's eNewsletter, and the Panel's Web Site to share and disseminate data and information to Panel members and other researchers.
5. The Panel endorses the following proposed Task Committee Workshop during the coming year:

Task Committee G, 27th U.S.-Japan Bridge Engineering Workshop, 7-9 November 2011, Tsukuba, Japan

In the event that T/C co-chairs recommend conducting a joint meeting or workshop under the auspices of the UJNR Panel on Wind and Seismic Effects prior to the next annual meeting, that is not included in the above list, the T/C co-chairs will make a request to conduct the meeting through their respective Secretary-General for approval by the Joint Panel Chairmen.

6. The U.S. and Japanese Panel members will jointly examine damage caused by the 2011 Great East Japan Earthquake and ensuing tsunami in three separate teams, i.e., buildings, dams, and tsunami, during Japan-hosted technical site visits following the technical meeting.

7. The U.S. and Japan sides will plan, conduct, and share as appropriate, joint investigations following earthquake and wind disasters in the U.S., Japan and other countries.
8. The Forty-Fourth Joint Panel Meeting of the UJNR Panel on Wind and Seismic Effects will be organized by the U.S.-side Panel, to be held in the U.S. tentatively in May 2012. The U.S.-side Secretariat will propose dates, meeting format, program, location, and itinerary with the concurrence of the Japan-side Panel.

STRATEGIC PLAN

ADDENDUM 2 (TENTATIVE)
Panel Expectations During 2011-2015

STRATEGIC PLAN
U.S.-JAPAN JOINT PANEL ON WIND AND SEISMIC EFFECTS

1. Introduction

This document is Addendum 2 of the Strategic Plan for the US-Japan Panel on Wind and Seismic Effects 2001-2005 (attachment). The Panel's 2001 Strategic Plan serves as the base of the Panel's operations and structure. This Addendum 2 provides a roadmap of outlined technical approaches for the Panel's operations during the next five-year period 2011-2015. As background, the Panel's Charter, developed in 1987 at the 19th Joint Panel Meeting, is to:

- a. Encourage, develop, and implement the exchange of wind and seismic technology between appropriate US and Japanese organizations to share scientific and technological knowledge.
- b. Develop strong technical links of scientific and engineering researchers between the two countries and encourage exchanges of guest researchers.
- c. Conduct joint research in areas of winds and seismic technology including exchange of available research equipment and facilities in both countries. Publish findings from joint research efforts.
- d. Conduct cooperative programs to improve engineering design and construction practices and other wind and earthquake hazard mitigation practices. Publish results from cooperative programs.

The Panel is worthy of continuation based on the fact that it is equipped with the following unique features:

1. UJNR is a government-to-government cooperation program in principle, and responsible information exchange between countries is possible, in terms of technical policies, design codes, technical standards and so forth. This also enables efficient reconnaissance surveys after a major disaster in either country, which was demonstrated in the case of the 2011 Great East Japan Earthquake.
2. The Panel is a comprehensive cooperation framework that covers wide areas such as transportation facilities, dams, buildings and ports. It is one of the Panel's advantages to be able to collect and integrate various opinions and views with relation to wind and earthquake engineering.
3. The built environments and construction processes in the two countries have many similarities that make information sharing very productive, and the two countries have uniquely complementary research capabilities.

2. Panel Approaches During 2011-2015

The Panel's operational procedure is defined in the attached Strategic Plan (2001-2005). Annually the Panel performs a self-evaluation during a Strategic Planning session held during its Joint Panel Meeting. Based on the Panel's evaluation, incremental modifications are carried out to enhance the Panel's operations and to bring 'value-added' to its users.

2.1. Panel Mission and Vision for 2011-2015

1. Continue performing post disaster investigations and reconnaissance and sharing findings with Panel members and others as was carried out for:
 - a) Earthquakes: (2004 Niigata, 2004 Indonesia, 2005 Pakistan, 2007 Off Niigata, 2009 L'Aquila Italy, 2010 Chile, 2010-2011 Christchurch New Zealand, 2011 Great East Japan and others)
 - b) Typhoons and Hurricanes: (2005 Katrina and Rita, 2004 Typhoon, 2008 EF5 Tornado and the 2011 Joplin EF5)
2. Share US and Japan National Disaster Mitigation Plan and Science and Technology Policy among the Panel members such as:
 - a) USA. NSTC/SDR: *Grand Challenge for Disaster Prevention- a 10-year strategy for disaster reduction through science and technology; Windstorm Impact Reduction Implementation Plan*; the NEHRP Strategic Plan.
Rapid Response Research (RAPID) to study the impact of federal investments in science and technology programs and to advance the scientific understanding of science policy
 - b) Japan. Central Disaster Prevention Council (2005): *Reduction by half of human damage and economic damage in coming 10 years*, Technology Development Plan at “Council for Science and Technology”
Central Disaster Prevention Council (2008): *A comprehensive plan for achieving “no victim” from natural disasters*.
Reconstruction Headquarters in response to the Great East Japan Earthquake (2011): *A basic policy on reconstruction from the Great East Japan Earthquake*.
Cabinet Office (2011): *The 4th Science and Technology Basic Plan (2011-2016)*
3. Identify methods that support each countries efforts in disaster mitigation through cooperation between the US and Japan and explore opportunities for joint research projects.
4. During 2011-2015 the Panel will focus on topics such as:
 - a) In view of the impacts of the 2011 Great East Japan Earthquake, study the instrumented buildings that are similar to U.S. construction and that experienced significant motions
 - b) Study the impact of long duration ground motions on the design of the built environment and in particular buildings, dams, bridges and ports
 - c) Pursue collaborative research to study the effects of the Tohoku tsunami on Japanese buildings, bridges and other structures that are similar to US construction, in order to enhance and modernize tsunami design codes
 - d) Facilitate exchange of technical information on future typhoons, hurricanes and tornadoes
 - e) Continue to understand causes and effects of wind and seismic hazards and pursue the accumulation and interpretation of data
 - f) Evaluate and estimate risk of natural hazards
 - g) Improve/develop disaster mitigation technology and methodology, and dissemination of disaster response technology into practical applications
 - h) Promote attention to increase research that considers societal implications of natural disasters
 - i) Integrate technology development and the viewpoint of social/civil engineering by

increasing the importance of the cooperative works between related UJNR Panels, the Panel's Task Committees, and the private sector and academia

- j) Create methods to better integrate comprehensive technology information as a base for transmitting information throughout the Panel member's organizations
- k) Contribute to dissemination of cooperative products that will facilitate global standardization of related civil engineering technologies

2.2. Evaluate Task Committees. The Panel operates under six Task Committees including one reformed on the occasion of the Forty-third Joint Panel Meeting in 2011; an optimum number for Panel management and productivity. The Task Committees serve as the heart of the Panel's operations:

- Task Committee A. Strong Motions and Effects
- Task Committee B. Buildings
- Task Committee C. Dams
- Task Committee D. Wind Engineering
- Task Committee G. Transportation Systems
- Task Committee H. Storm Surge and Tsunami

Findings from Task Committees' evaluations will help the Task Committees 1) measure achievements, productivity, and impact on contributions to improving design and construction practices, 2) identify opportunities for making contributions and addressing emerging technical challenges, and 3) assess when they completed their mission and are ready for retirement. Task Committee Evaluation Criteria includes: 1) one or more workshop conducted at least every three-years, 2) implementing recommendations from workshops, 3) publications and other outreach, and 4) collaborations beyond their Task Committee.

The Panel will encourage its respective Task Committees to identify thematic focuses requiring technology sharing and joint collaborations. These Themes will be discussed at annual Panel Meetings. The Panel will consider the merits of creating new Task Committees that meet special needs and eliminating Task Committees that have completed their mission or can be strengthened through consolidation with other Task Committee(s).

2.3. Partnering Opportunities. Identify partnering opportunities through clustering appropriate Panel's Task Committees, collaborating with other UJNR Panels, and working together with the private sector and academia. Clustering provides Task Committee optimization of resources (human and financial). Partnering and clustering will be discussed at Panel Meetings including increasing participation from the private sector and academia.

2.4. Joint Research. Perform joint research initiated by the Panel and its Task Committees. The Task Committees are encouraged to identify key joint-research opportunities to improve the state-of-knowledge or to consider engaging in a significant long-term research funded from one or more sponsoring organizations. For the latter, below are the Panel Cooperative Research Projects performed during the past 32-years that improved design and construction practices for both countries.

1. Reinforced Concrete Structures (1979-1987); accomplishments include testing six-story full scale buildings which led to improve seismic design methods of reinforced concrete

- buildings.
2. Seismic Performance of Lifeline Facilities (1982-1989); accomplishments include development of improved seismic design methods of bridge columns.
 3. *In-situ* Testing Methods for Soil Liquefaction (1983-1986); accomplishments include development of rationale for Standard Penetration Test (SPT) data based on energy ratio.
 4. Masonry Structures (1984-1988); accomplishments include development of strength-based design guidelines for reinforced masonry buildings.
 5. Steel-Frame Structures (1985-1987); accomplishments include testing of a full-scale five-story building to confirm prediction of performance based on components and subassemblages.
 6. Bridge Hybrid Control Systems (1990-1994); accomplishments include development of hybrid control algorithms that require less energy for controlling bridge response.
 7. Precast Seismic Structural Systems (1991-1992); accomplishments include development of strength-based design guidelines.
 8. Seismic Performance of Composite and Hybrid Structures (1993-1998); accomplishments include development of design guidelines for composite and hybrid system, and development of new materials.
 9. Countermeasures for Soil Liquefaction (1994-2004); accomplishments include contributions on the revision of design guidelines for building foundations and formulation of soil experiment plans using E-Defense.
 10. Development of Smart Structural Systems (1998-2003); accomplishments include development of structural performance detection technology and structural members using intelligent materials.
 11. Develop Comparative Analysis of Seismic Performance Testing Guidelines for Bridge Piers (1999-2006); accomplishments include a joint publication on the comparative analysis of US and Japan bridge piers.
 12. Flutter Derivatives on Bridge Girders (2002-2006); accomplishments include comparisons of flutter derivatives on bridge girders by US and Japan wind tunnel tests.
 13. Wind Effects on Typical Low-Rise Industrial Buildings (2003-2008); accomplishments include comparisons of wind pressures on low-rise buildings by US and Japan wind tunnel tests.
 14. Non-linear Response Analysis and Discrete Element Method Analysis of Concrete Dams (2006-present).

During the period of 2011-2015, the Task Committees are encouraged to commence new joint researches, for example, under the following themes:

1. Lessons learned from instrumented structures whose responses were recorded during the 2011 Great East Japan Earthquake and aftershocks (Task Committee A)
2. Develop a coordinated research program regarding structural wall performance (Task Committee B)
3. Study of Tornadic Flow and Effects on Buildings Structures (Task Committee D)
4. Benchmark Study on Flutter Derivatives (Task Committee D)
5. Strategy to determine design criteria, design loads, and load factors that consider ductility and redundancy for multiple hazards (Task Committee G)
6. Study on policy making to set different performance levels of routes and allocate resources for seismic upgrading/retrofit, bridge inspection, and rehabilitation based on

- the assigned characteristics (Task Committee G)
7. Study on tsunami damage estimation in modern coastal cities (Task Committee H)

The respective Task Committees will identify candidate joint research for discussion at annual Panel meetings.

2.5. Panel Communications. More broadly disseminate Panel's activities, accomplishments, and impacts including findings from post-disaster investigations using the Panel's eNewsletter, a more active Web Site, Task Committee publications, and identify Panel accomplishments and impacts. The Panel will increase information sharing among its member organizations and include links to related organizations in both countries. Task Committees will serve as a knowledge base of information on their respective themes and share their information to users following methods described above.

2.6. Joint Panel Meeting Format. The Panel has reorganized its annual Joint Meeting format since the Forty-third Joint Panel Meeting in 2011. The Panel holds two types of Joint Panel Meeting alternately: Joint Panel Meetings for the Chairmen and Secretaries-General of the both sides and other interested parties, and the full Joint Panel Meetings.

3. Conclusion

This Addendum represents the Panel's focus to address panel's activities of the next five-years. The strategic plan is evaluated during its Meetings.

ADDENDUM 1
Panel Expectations During 2006-2010

STRATEGIC PLAN
U.S.-JAPAN JOINT PANEL ON WIND AND SEISMIC EFFECTS

1. Introduction

This document is Addendum 1 of the Strategic Plan for the US-Japan Panel on Wind and Seismic Effects 2001-2005 (attachment). The Panel's 2001 Strategic Plan serves as the base of the Panel's operations and structure. This Addendum 1 provides a roadmap of outlined technical approaches for the Panel's operations during the next five-year period 2006-2010. As background, the Panel's Charter, developed in 1987 at the 19th Joint Panel Meeting, is to:

- a. Encourage, develop, and implement the exchange of wind and seismic technology between appropriate US and Japanese organizations to share scientific and technological knowledge.
- b. Develop strong technical links of scientific and engineering researchers between the two countries and encourage exchanges of guest researchers.
- c. Conduct joint research in areas of winds and seismic technology including exchange of available research equipment and facilities in both countries. Publish findings from joint research efforts.
- d. Conduct cooperative programs to improve engineering design and construction practices and other wind and earthquake hazard mitigation practices. Publish results from cooperative programs.

2. Panel Approaches During 2006-2010

The Panel's operational procedure is defined in the attached Strategic Plan (2001-2005). Annually the Panel performs a self-evaluation during a Strategic Planning session held during its May Joint Panel Meeting. Based on the Panel's evaluation, incremental modifications are carried out to enhance the Panel's operations and to bring 'value-added' to its users.

2.1. Panel Mission and Vision for 2006-2010

1. Continue performing post disaster investigations and reconnaissance and sharing findings with Panel members and others as was carried out for:
 - a) Earthquakes: (2004 Niigata, 2004 Indonesia, 2005 Pakistan, and others)
 - b) Typhoons and Hurricanes: (2005 Katrina and Rita, 2004 Typhoon)
2. Share US and Japan National Disaster Mitigation Plan among the Panel members such as:
 - a) USA. NSTC/SDR: *Grand Challenge for Disaster Prevention- a 10-year strategy for disaster reduction through science and technology; Windstorm Impact Reduction Implementation Plan*; the NEHRP Annual Plan.
 - b) Japan. *Central Disaster Prevention Council: Reduction by half of human damage and economic damage in coming 10 years*, Technology Development Plan at "Council for Science and Technology"
3. Identify methods that support each countries efforts in disaster mitigation through cooperation between the US and Japan and explore opportunities for joint research projects.

4. During 2006-2010 the Panel will focus on topics such as:
 - a) Continue to understand causes and effects of wind and seismic hazards and pursue the accumulation and interpretation of data
 - b) Evaluate and estimate risk of natural hazards
 - c) Improve/develop disaster mitigation technology and methodology, and dissemination of disaster response technology into practical applications
 - d) Promote attention to increase research that considers societal implications of natural disasters
 - e) Integrate technology development and the viewpoint of social/civil engineering by increasing the importance of the cooperative works between related UJNR Panels, the Panel's Task Committees, and the private sector and academia
 - f) Create methods to better integrate comprehensive technology information as a base for transmitting information throughout the Panel member's organizations
 - g) Contribute to dissemination of cooperative products that will facilitate global standardization of related civil engineering technologies

2.2. Evaluate Task Committees. The Panel operates under seven Task Committees; an optimum number for Panel management and productivity. The Task Committees serve as the heart of the Panel's operations:

- | | |
|-------------------|-----------------------------------------------------|
| Task Committee A. | Geotechnical Engineering and Ground Motion |
| Task Committee B. | Next Generation Building and Infrastructure Systems |
| Task Committee C. | Dams |
| Task Committee D. | Wind Engineering |
| Task Committee G. | Transportation Systems |
| Task Committee H. | Storm Surge and Tsunami |
| Task Committee I. | Fire Performance of Structures |

Findings from Task Committees' evaluations will help the Task Committees 1) measure achievements, productivity, and impact on contributions to improving design and construction practices, 2) identify opportunities for making contributions and addressing emerging technical challenges, and 3) assess when they completed their mission and are ready for retirement. Task Committee Evaluation Criteria includes: 1) one or more workshop conducted at least every three-years, 2) implementing recommendations from workshops, 3) publications and other outreach, and 4) collaborations beyond their Task Committee.

The Panel will encourage its respective Task Committees to identify thematic focuses requiring technology sharing and joint collaborations. These Themes will be discussed at annual Panel Meetings. The Panel will consider the merits of creating new Task Committees that meet special needs and eliminating Task Committees that have completed their mission or can be strengthened through consolidation with other Task Committee(s).

2.3. Partnering Opportunities. Identify partnering opportunities through clustering appropriate Panel's Task Committees, collaborating with other UJNR Panels, and working together with the private sector and academia. Clustering provides Task Committee optimization of resources (human and financial). Partnering and clustering will be discussed at annual Panel Meetings including increasing participation from the private sector and academia.

2.4. Joint Research. Perform joint research initiated by the Panel and its Task Committees. The Task Committees are encouraged to identify key joint-research opportunities to improve the state-of-knowledge or to consider engaging in a significant long-term research funded from one or more sponsoring organizations. For the latter, below are the Panel Cooperative Research Projects performed during the past 27-years that improved design and construction practices for both countries.

1. Reinforced Concrete Structures (1979-1987); accomplishments include testing six-story full scale buildings which led to improve seismic design methods of reinforced concrete buildings.
2. Seismic Performance of Lifeline Facilities (1982-1989); accomplishments included development of improved seismic design methods of bridge columns.
3. *In-situ* Testing Methods for Soil Liquefaction (1983-1986); accomplishments include development of rationale for Standard Penetration Test (SPT) data based on energy ratio.
4. Masonry Structures (1984-1988); accomplishments include development of strength-based design guidelines for reinforced masonry buildings.
5. Steel-Frame Structures (1985-1987); accomplishments include testing of a full-scale five-story building to confirm prediction of performance based on components and subassemblages.
6. Bridge Hybrid Control Systems (1990-1994); accomplishments include development of hybrid control algorithms that require less energy for controlling bridge response.
7. Precast Seismic Structural Systems (1991-1992); accomplishments include development of strength-based design guidelines.
8. Seismic Performance of Composite and Hybrid Structures (1993-1998); accomplishments include development of design guidelines for composite and hybrid system, and development of new materials.
9. Countermeasures for Soil Liquefaction (1994-2004); accomplishments include contributions on the revision of design guidelines for building foundations and formulation of soil experiment plans using E-Defense.
10. Development of Smart Structural Systems (1998-2003); accomplishments include development of structural performance detection technology and structural members using intelligent materials.
11. Develop Comparative Analysis of Seismic Performance Testing Guidelines for Bridge Piers (1999-2006); accomplishments included a joint publication on the comparative analysis of US and Japan bridge piers.

The respective Task Committees will identify candidate joint research for discussion at annual Panel meetings.

2.5. Panel Communications. More broadly disseminate Panel's activities, accomplishments, and impacts including findings from post-disaster investigations using the Panel's eNewsletter, a more active Web Site, Task Committee publications, and identify Panel accomplishments and impacts. The Panel will increase information sharing among its member organizations and include links to related organizations in both countries. Task Committees will serve as a knowledge base of information on their respective themes and share their information to users following methods described above.

3. Conclusion

This Addendum represents the Panel's focus to address panel's activities of the next five-years. The strategic plan is annually evaluated during its annual May Meetings.

U.S.-Japan Joint Panel on Wind and Seismic Effects Strategic Plan

1. Introduction

1.1 Context

The U.S. and Japan must maintain an awareness of international developments in earthquake and wind mitigation technology. The international exchange of information is achieved through a combination of formal and informal mechanisms, including: attendance at conferences and workshops; cooperative research projects and programs; and exchange of scientists and engineers. There is a long-established tradition of joint research activities between Japan and the United States. The U.S.-Japan Cooperative Program in Natural Resources (UJNR) Panel on Wind and Seismic Effects (WSE Panel) provides a formal government-to-government mechanism for cooperation between the two countries in the area of earthquake and wind mitigation technology.

At the 32nd Joint Panel Meeting, a resolution was passed to establish a joint Ad-Hoc Committee for the purpose of developing a strategic plan for the WSE Panel. The catalyst for this effort was the need to address immediate issues related to cost and participation. While the Panel recognized the importance of addressing these immediate issues, it also realized that an opportunity existed to strengthen the WSE Panel's focus on its core mission and foster greater collaboration between researchers in the U.S. and Japan while streamlining the overall operation of the Panel. It was with this goal in mind that the ad-hoc committee developed the strategic plan contained in this document.

1.2 Approach

Before meeting to develop the strategic plan, each side held domestic panel meetings and conducted one-on-one meetings with participating agencies to identify issues that needed to be addressed by the strategic plan and to understand which features of the Panel and its operation should be retained and which needed to be changed or adapted to meet current and future needs. Each side developed a concept paper to capture these ideas. The concept papers, however, tended to focus on addressing the immediate issues rather than positioning the Panel to address the needs and challenges of the future. Through the exchange of the concept papers and subsequent discussion, the two sides moved close to agreement on near-term changes to the Panel's operation. Thus, the strategic plan emphasizes longer-term goals for the operation and growth of the Panel and a time-phased approach to implementation of steps to achieve these goals.

The strategic plan is intended to establish a course for the WSE Panel over the next 5-10 years. It recognizes that there are many ways in which the Panel may work to achieve the goals identified, and so while some steps in the implementation process are clear, others are left open to be determined through experimentation. However, the Panel believes working toward the goals identified will strengthen its role in engineering and scientific communities of the U.S. and Japan and will allow our countries to make more efficient use of resources to conduct research and disseminate results to the benefit of both countries.

2. Role of the Panel

2.1 Guide Research Agendas

As a government-to-government mechanism for collaboration, the WSE Panel is in a unique position to guide the development and execution of each country's research agenda. Currently, each country defines its own research priorities, projects are formulated in a fragmented manner, and results are reported through vehicles such as the Annual Joint Panel Meeting. By strengthening its ties to industry and academia, the Panel will be able to identify specific research needs and align those with government priorities. The Panel shall work toward a coordinated research agenda that permits the efficient use of human resources, funding, and research facilities to achieve mutual research objectives.

The new Task Committees formed through implementation of this strategic plan shall work to identify areas where joint research projects can be established and conducted as a part of a coordinated research agenda. Joint research projects may include participation by university or industry researchers in addition to member agency researchers.

2.2 Leverage Resources

The U.S. and Japan each possess significant expertise in the fields of earthquake and wind engineering and have a substantial investment in equipment and facilities to perform testing and measurements in support of research in these fields. Historically, the WSE Panel has facilitated the exchange of researchers between the U.S. and Japan but has not made a concerted effort to leverage the resources of the two countries. There is an opportunity for the Panel to coordinate research activities to efficiently utilize testing and measurement facilities in both countries to address mutual research needs and avoid duplication. This is an area in which the Panel can significantly strengthen its efforts and provide a tangible benefit to each country by working to establish strong partnerships for coordinated research.

2.3 Foster Cooperation

From its founding, the WSE Panel has promoted cooperation between the U.S. and Japan through annual Joint Panel Meetings, Task Committee activities, and exchange of researchers. One of the hallmarks of success for the WSE Panel through the years has been the high level of cooperation. The model these cooperative efforts have been built around, however, is one of information exchange. While the exchange of information and research results is an important facet of the WSE Panel's work, there is the opportunity to greatly expand the scope and importance of cooperative efforts to leverage resources (people, funding, facilities) through joint research projects of bilateral importance. Additionally, the Panel should look beyond the government agencies that participate to be more inclusive of universities and the private sector. At a minimum, this will include broadening participation in the Joint Panel Meetings to include industry and university participants. As industry and universities become more engaged, exchanges of researchers among government, university, and industry participants may be possible. Joint programs that include participation by government, industry, and university partners shall also be considered. These activities would broaden the reach of the Panel and provide a means for more rapid diffusion of research results into practice.

2.4 Technical Exchange

The WSE Panel has, throughout its history, been an effective mechanism for the exchange of

technical information between Japan and the United States. Further, the WSE Panel has provided a means for disseminating measurements and research results to other nations affected by earthquake, wind, tsunami, and storm surge hazards. Annual Joint Panel Meetings, Task Committee Meetings and Workshops, researcher exchange programs, and personal relationships among researchers have fostered this exchange. The Panel recognizes this as one of its strengths and should seek to broaden its reach to include participation by researchers in other nations. The Panel should explore means of increasing collaboration with other countries through inclusion of representatives from other nations in Joint Panel Meetings, encouraging joint projects through the Task Committees that include partners outside the U.S. and Japan, and through the exchange of researchers with other countries.

2.5 Engage Private Sector

The WSE Panel has engaged the private sector to a limited extent in its activities during its history, although the work of the Panel and the participating agencies can have a direct benefit to industry and ultimately the public in our respective countries. Further, some larger companies have research capabilities and programs that could enrich the Panel. More actively engaging the private sector will provide a means for obtaining input in setting priorities and for more rapidly diffusing the results of research activities into practice within Japan and the United States. The involvement of the private sector may include participation in the development of coordinated research agendas and dissemination of information perhaps through special sessions at the annual Joint Panel Meetings. The Panel should also consider involving the private sector in research projects coordinated at the Task Committee level that will have broad-based benefits to industry in both countries. Longer-term, the involvement of the private sector will facilitate dialogue between practicing engineers and builders in Japan with their counterparts in the U.S. The Joint Panel will examine ways to increase industry participation, initially by inviting key industry representatives to participate in Joint Panel Meetings and to speak about the work of their company or organization and explore possibilities for greater collaboration.

2.6 Web Page Development

The Joint Panel will explore ways to increase utilization of the Internet as a means of communication both among Panel members and with outside organizations. The Japan-side has offered to take the lead in developing an Internet presence for the Joint Panel and has begun work on an initial concept for the site. Once the site is established, the Task Committees will be relied on to provide, maintain, and update content related to their activities. The Joint Panel will also explore ways of using Internet resources as a means of facilitating communication among researchers as well as the exchange and dissemination of information and research results.

3. Implementation

3.1 Strategic Plan Development and Approval

This strategic plan was prepared through the efforts of the Joint Ad-Hoc Committee appointed by the Chairmen following the 32nd Joint Panel Meeting. The Joint Panel shall work toward approval of the Strategic Plan during the 33rd Joint Panel Meeting May 28-30, 2001. The approved document will reflect comments received from Panel members on the draft. Implementation of the strategic plan will begin with approval and require 12-24 months for full implementation.

3.2 Task Committee Charters and Recommended Committees

The US- and Japan-side Panels have agreed on the following seven themes around which Task Committees may be formed:

Theme A: Geotechnical Engineering and Ground Motion

Theme B: Buildings

Theme C: Dams

Theme D: Wind

Theme E: Lifelines

Theme F: Seismic Information and IT

Theme G: Transportation

Theme H: Storm Surge and Tsunami

Theme I: Public Health

Task Committee formed to address one of these themes will be approved by the Joint Panel on annual basis, provided that the Task Committee remains active. The criteria for active Task Committees are following:

- a) Conducts joint workshops or technical meetings on a regular basis for the purpose of exchanging technical information, research results, or data for the mutual benefit of both countries.
- b) Engages in frequent exchange of researchers for the purpose of technical interchange and collaboration on research.
- c) Conducts one or more joint research projects having clearly defined technical objectives, finite duration, and shared responsibility for producing technical results.

Task Committees will report results through papers presented during the joint panel meeting and through task committee reports. The Joint Panel will review task committee results and future plans on an annual basis and will approve task committees for the next year based on this information.

For this year, new task committees may be established by requesting approval through the Secretary-Generals at any time before the 34th Joint Panel Meeting.

3.3 Transition to New Annual Panel Meeting Format

A number of alternative formats for the annual Joint Panel Meeting were considered. Based upon the input received from Panel members, the basic format of the Joint Panel Meeting be retained. Session topics will be principally driven by the Task Committees. Each Task Committee would be given one session during which it would be able to present research results. This Task Committee-driven format should strengthen the role of the Task Committees and is intended to stimulate greater cooperation among researchers in each country. This format will foster the exchange of information that many have expressed is a desirable feature of the Joint Panel Meeting.

The Joint Panel meeting will be shortened by one day (from 4 days to 3 days). The shorter meeting, coupled with a shorter Technical Site Tour will reduce the time commitment for

participants to one week. This is intended to encourage greater participation in the Panel Meetings and Site Tours, particularly by members of the visiting Panel.

Finally, the Joint Panel will explore streamlining the Joint Panel Meeting to maximize the opportunity for technical exchange.

The shortened Panel Meeting/Technical Site Tour format is implemented for the first time at the 33rd Joint Panel Meeting. The Task Committee-driven technical meeting format will be implemented at a later date when the revised Task Committee organization is in place.

4. Conclusion

The plan outlined above represents a strategic plan for positioning the Joint Panel to meet the challenges of the future, while retaining those aspects that have contributed to its success through its 32 year history. This plan is intended to address the current realities of the Panel, as well as increase the value and contribution of the Panel to the U.S. and Japan. Full implementation of the strategic plan will take approximately two years.

PAPERS

The lessons of the Great East Japan Earthquake 2011 and the countermeasures against earthquakes and tsunami in future- Fundamental Concepts behind Future Tsunami Disaster Prevention –

by

Shigeo Ochi¹, Mao Suzuki²

ABSTRACT

At 14:46 on March 11, 2011, a massive moment magnitude 9.0 earthquake occurred off the Sanriku coast. The Great East Japan Earthquake vastly exceeded expectations in all aspects, such as the scale of the earthquake, the height of the tsunami, the extent of flooding, the broad extent of subsidence, and the scale of human and material loss; the enormity of loss centered on Iwate, Miyagi and Fukushima prefectures is the greatest since World War II. It is necessary to seriously accept the fact that enormous damages clearly exceeding prior and existing predictions occurred recently, improve past concepts, reexamine everything from prediction of earthquakes and tsunamis to disaster prevention measures, and rebuild a disaster prevention plan for the future. Based on the occurrence of the recent colossal tsunami and the damages that it caused, it was revealed that there are problems with disaster prevention measures that overly depend on shore protection facilities. As a result, it is necessary to combine land usage, evacuation facilities, disaster prevention facilities, etc., focusing on resident evacuation, and to establish comprehensive tsunami measures that incorporate every possible measure, both hard and soft.

KEYWORDS: Evacuation behavior, Predictions of earthquakes and tsunamis, The Great East Japan Earthquake, Tsunamis of two levels,

1. INTRODUCTION

Due to geographical, topographical, geological and meteorological conditions, Japan has experienced numerous kinds of natural disasters, including earthquakes, tsunami, volcanic eruptions, typhoon, torrential rain and heavy snowfall. This is particularly the case with regard to earthquakes; despite Japan only making up a minuscule 0.25% of the earth's land surface, roughly 20% of all magnitude 6.0 or higher earthquakes worldwide

between 2000 and 2009 have occurred within or in the vicinity of Japan's islands. While many lives and much property have been lost to natural disasters, advances such as the development and strengthening of disaster prevention systems, the promotion of national land conservation and the improvement of meteorological forecasting have improved Japan's capacity to respond, and lessened its vulnerability to, natural disasters. This has resulted in a downward trend in damage due to natural disasters since the middle of the 20th century. (Fig.1)

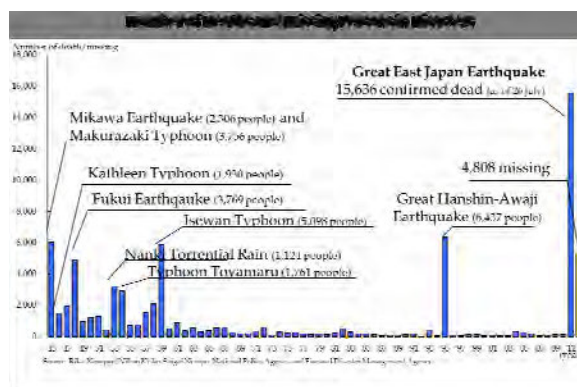

Fig.1 Number of deaths and missing persons in disasters[1]

However, the Great Hanshin-Awaji Earthquake in 1995 smashed the morning calm and reinstilled in

1 Director for Earthquake, Volcanic and Large-scale Disaster Management Bureau, Cabinet Office, 1-2-2 Kasumigaseki, Chiyoda-ku, Tokyo 100-8969 Japan

2 Chief of project section, for Earthquake, Volcanic and Large-scale Disaster Management Bureau, Cabinet Office, 1-2-2 Kasumigaseki, Chiyoda-ku, Tokyo 100-8969 Japan

the Japanese a sense of the danger of earthquakes. And then the Great East Japan Earthquake that struck on March 11, 2011 brought another terrible reminder to the Japanese that, when living in a country prone to earthquakes, no amount of contingency planning can completely protect against natural disasters. The Japanese islands are located at the point where four of the earth's tectonic plates meet - the Eurasian and North American continental plates and the Pacific and Philippine Sea oceanic plates. This is one of the reasons why earthquakes are so frequent in Japan. At the point where the continental and oceanic plates meet, the oceanic plates are sliding under the continental plates, and this subduction pulls the continental plates downward; when the limit of how far the continental plates can be pulled downward is reached, they snap back upwards, creating powerful ocean trench earthquakes. Classic examples of such massive ocean trench earthquakes are the Tokai, Tonankai and Nankai megathrust earthquakes occurring at the Suruga and Nankai troughs; and the 2005 Miyagi Earthquake and the recent Great East Japan Earthquake occurring at the Japan Trench. Also, there are numerous active faults within Japan, with the specific number being put at around 2000. Even a magnitude 7 earthquake will cause extensive damage if it occurs directly beneath a city; the Great Hanshin-Awaji Earthquake of 1995 is a case in point, as the epicenter of the earthquake was an active fault.

Turning our attention to tsunamis, we find that there have been eight tsunamis, including the tsunami resulting from the Great East Japan Earthquake, since the Meiji Era (1868) with death tolls of 100 or more people. All of these tsunamis followed magnitude 7.5 or greater earthquakes, and using the number of dead or missing as an index, we see that the top three tsunamis (which accompanied the Great East Japan Earthquake, 1896 Meiji-Sanriku Earthquake and the 1933 Sanriku Earthquake, respectively) all struck the Sanriku coastline; this suggests that the Sanriku area has long been prone to sustaining significant damage from tsunamis. Also, since 1980 there have been 13 earthquakes producing tsunamis at least 50cm high, which is an average of one such tsunami every two to three years. And of these 13 tsunamis, those that followed the 1983 Central

Japan Sea Earthquake, the 1993 Hokkaido-Nansei-Oki Earthquake, the 2010 Chile Earthquake and the 2011 Great East Japan Earthquake were large enough to trigger the warning system for giant tsunamis. With the exception of the tsunami produced by the far off Chile Earthquake, each of these tsunamis resulted in at least 100 people killed or missing.

In this paper, we discuss the lessons learned from, and earthquake and tsunami countermeasures resulting from, the Great East Japan Earthquake of March 11, 2011, focusing on the interim report of the Central Disaster Prevention Council's "Expert Panel on Applying the Lessons of the Great East Japan Earthquake to Japan's Earthquake and Tsunami Countermeasures" (hereafter, "Expert Panel") released on June 26, 2011. Chapter 2 will provide a general overview of the Great East Japan Earthquake, including the distribution of seismic intensity, distribution of fault slippage and vestiges of the tsunami. Chapter 3 will look at the damage and other results of the seismic ground motion and the tsunami. Chapter 4 introduces the thinking that has underscored earthquake and tsunami countermeasures prior to the Great East Japan Earthquake. Reflections on the disconnect between expected and actual damage will be touched upon. Chapter 5 will take those reflections and apply them to the thinking for future disaster-prevention countermeasures targeted at earthquakes and tsunamis. Chapter 6 will touch on the future direction of earthquake and tsunami countermeasures, and Chapter 7 will summarize the outlook for the future. The content of chapters 4 through 6 will largely reflect the content of the Expert Panel's interim report.

2. OVERVIEW OF THE 2011 THE GREAT EAST JAPAN EARTHQUAKE

At 14:46 on March 11, 2011, a massive moment magnitude 9 earthquake occurred off the Sanriku coast. The depth of the earthquake was 24km and, on the moment magnitude scale, it was the fourth largest earthquake in the world since the start of the 20th century [2]. The ground motion from the earthquake were picked up by seismic intensity meter in the Tohoku and Kanto regions and everywhere else in Japan from Hokkaido to Kyushu; the strongest measurement was JMA seismic intensity scale 7 in Kurihara City, Miyagi

Prefecture, and from Iwate Prefecture all the way to Chiba Prefecture, the earthquake measured at least JMA seismic intensity scale 5-. The size of the area registering at least JMA seismic intensity scale 5+, which is capable of causing severe damage to buildings and other structures, was 35,000km², or roughly 10% of Japan's entire land area. The source region of the main shock stretches 450km north to south and 200km east to west, and the area around the epicenter moved at least 30m [3]. Because of the incredibly broad extent of asperity collapse, it took time to measure the collapse from start to finish. As a result, the reported magnitude of the earthquake announced by Japan Meteorological Agency was revised four times. Specifically, three minutes after the start of the earthquake, JMA reported it as magnitude 7.9; one hour and fifteen minutes later it was reported as magnitude 8.4; one and a half hours later it was reported as magnitude 8.8; and two days later it was reported as having a moment magnitude of 9.0.

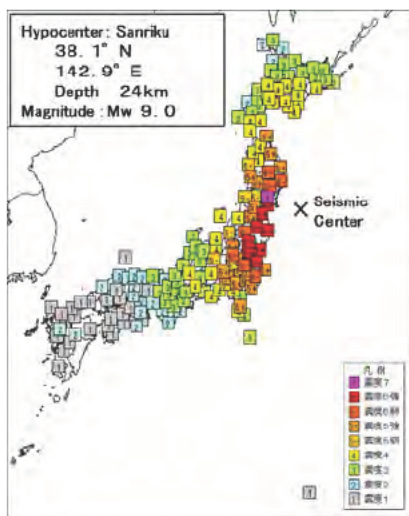

Fig.2 Observed Intensity [4]

Also, the graph of the seismic source time function, which represents the seismic energy released, shows that a significant amount of energy was released over a span of more than three minutes. Not only was this earthquake powerful, it was also extremely long in duration. Fig.3 plots, at ten second intervals, the values obtained from waveform data produced by seismic intensity meters in various regions and are based on JMA seismic intensity scale. We can see that the

earthquake registered intensity scale 4 or higher in Otemachi in Tokyo's Chiyoda Ward for roughly 130 seconds. In Gorin in Sendai City's Miyagino Ward, the earthquake registered intensity scale 4 or higher for roughly three minutes and at least intensity scale 5- for roughly two minutes.

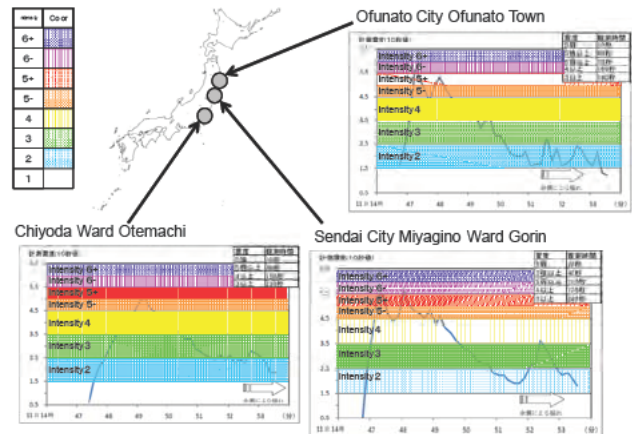

Fig.3: seismic intensity meters in various regions [4]

More damaging than seismic ground motion, however, was the massive tsunami that resulted from it, striking Japan's Pacific coast from Aomori Prefecture down to Chiba. JMA's records show that some tide level measuring facilities were themselves swept up in the tsunami, indicating that the tsunami far exceeded the tide level measurement range and making it impossible to obtain data from those spots. Thus, JMA worked together with various universities to look for vestiges of the tsunami to determine how far inland it went along the Pacific coast. (Fig.4)

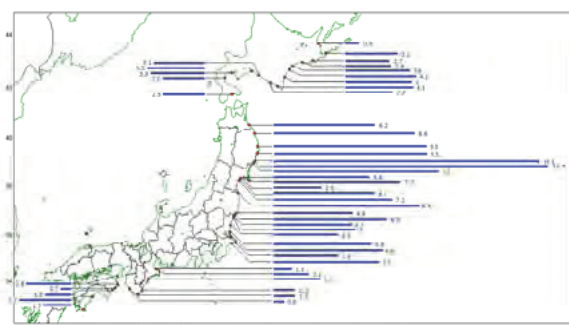

Fig.4: The height of tsunamis estimated from traces of tsunamis at the principal investigation points (unit : m) [4]

This is not the height of the tsunami but rather the height of the vestiges found. According to JMA's records, the largest value was 16.7 at Ofunato City, Iwate Prefecture; however, research by other scientific groups and research institutions record a height of more than 30m for the tsunami.

3. DAMAGE CHARACTERISTICS

3.1 Overview of Damage

The Great East Japan Earthquake vastly exceeded expectations in all aspects, such as the scale of the earthquake, the height of the tsunami, the extent of flooding, the broad extent of subsidence, and the scale of human and material loss; the enormity of loss centered on Iwate, Miyagi and Fukushima prefectures is the greatest since World War II. (Table 1)

Table 1: Earthquake and tsunami caused the tremendous degree and extent damage; as 12 prefectures. [5]

Human Loss	death: 15,687, missing: 4,757 (as at August 9, 2011)
Building Damage	Collapsed : 112,703 buildings, Partially : 143,760 buildings (as at August 9, 2011)
Applicable Disaster Relief Act	241 cities (10 prefectures) (※) including 4 cities applied on the northern Nagano earthquake

The damage is characterized by its tremendous degree and extent, which made it difficult to gather information and transport supplies, disrupted not only the supply chain in the affected regions but the socio-economic activity of all of Japan, resulted in disaster in sparsely populated and aged areas, and produced compounded damage from the combination of earthquake, tsunami and nuclear power plant accident.

This disaster has resulted in more than 20,000 dead or missing, with the majority being along the Tohoku coast, as well as caused 110,703 buildings to completely collapse and 143,760 to partially collapse.

In terms of transportation infrastructure, expressways, like the Tohoku Expressway, national roads and other roads were closed, with those along the Pacific coast being broken to pieces; in addition, harbor facilities and airport facilities stopped functioning. In terms of lifeline facilities, roughly 8.91 million homes lost power,

roughly 480,000 homes had their gas stop and roughly 2.2 million homes temporarily had their water service stop. The cost of the damage to this stock of infrastructure (buildings, lifeline facilities, social infrastructural facilities, etc.) is estimated to total approximately 16.9 trillion yen. (This figure does not include other types of damage, such as the damage to nuclear power plants, the damage caused by harmful rumors, and the damage to Japan's economy.)

Despite the fact that about 80% of these facilities as well as banks, post offices and other public institutions have been restored to working order, roughly half of the harbors and other such infrastructure remain unusable. (Table 2)

Table 2: Recovery level of infrastructures [5]

Lifeline as at July 14	
Electricity	About 96 %
City gas	About 86 %
Liquefied Petroleum Gas	About 95 %
Aqueduct	About 98 %
Gas station	About 85 %
Bank	About 80 %
Post office	About 84 %
Mail delivery	About 80 %
Fixed-line phone	About 99 %
Mobile phone	About 98 %
Traffic as at July 14	
Road (National Control)	About 99 %
Railway	About 96 %
Port	About 46 %

3.2 Tsunami Damage

The damage from the tsunami was particularly extensive and severe. This was particularly true along the Pacific coast from the Tohoku region, which was close to the source region, down to the Kanto region. The Tohoku region has a saw-tooth coastline along the Pacific Ocean, and some areas were hit with a tsunami wave over 20m tall, and in some plains areas, the tsunami reached 5km or more inland. Flooding covered 561km² of the affected regions and is believed to have extended up to 650km in a straight line along the coastline. (Fig.5)

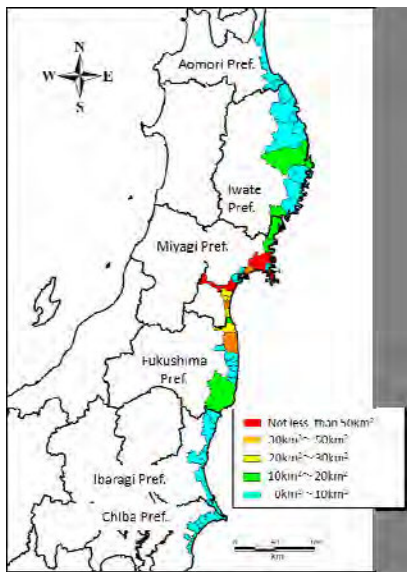

Fig.5 Flooded Area[4]

The extent of flood damage in a majority of these areas goes far beyond what is anticipated by tsunami hazard maps; in addition, the height of the tsunami in most of the flooded areas greatly exceeded the height anticipated by tsunami hazard maps. (Fig.6) (Fig.7)

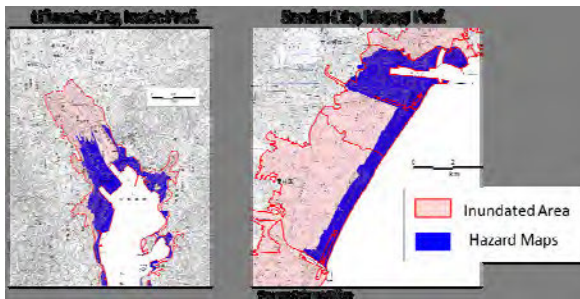

Fig.6: Comparison between flooded area and tsunami hazard map [4]

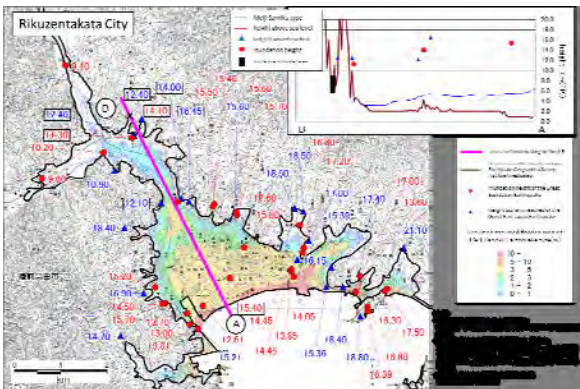

Fig.7: Flooded Area in Rikuzentakata City [4]

This giant tsunami generally devastated the entirety of the areas it affected, not only destroying houses and economic infrastructure but also knocking out municipalities' ability to respond to disasters. This is not just a serious blow to rescue and relief efforts but also to recovery and rebuilding efforts.

Over 92% of those who perished in the Great East Japan Earthquake drowned as a result of the tsunami. Furthermore, 65% of those who died were aged 65 or older. (Fig.8)

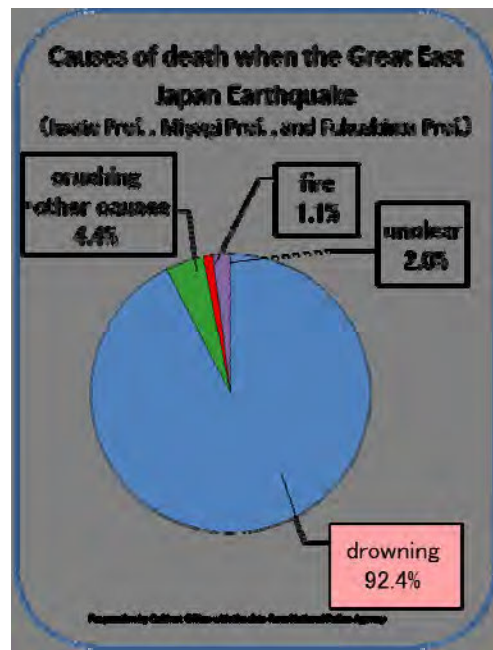

Fig.8: Causes of death when the Great East Japan Earthquake [1]

3.3 Earthquake Damage

Compared with the tremendous damage wreaked by the tsunami, the scale of the damage caused directly by the earthquake, such as building damage, was comparatively lower than the extensive damage one would assume for a M9.0 earthquake. This can largely be attributed to such factors as the relatively small amount of long-period ground motion (one to two second vibration cycles that cause wooden homes to collapse and several second or longer vibration cycles that cause high-rise buildings to sway) and improved seismic capacity and other countermeasures incorporated in response to past earthquakes like

the Great Hanshin-Awaji Earthquake. We must not only investigate, analyze and verify those phenomena, like the tsunami, that exceeded expectations but also those phenomena, like the earthquake damage, which were far below expectations, and we must incorporate what is learned from both into future disaster-prevention countermeasures.

3.4 Other Damage: Land Subsidence, Liquefaction Phenomena, Stranded Persons, etc.

The earthquake caused land subsidence to occur over a large area. The amount of land on the plains of Sendai at or below sea level prior to the earthquake was 3km²; however, after the earthquake it had grown roughly 530% to 16km². (Fig.9)

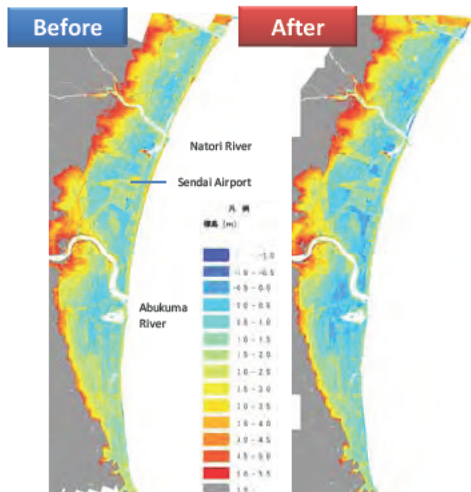

Fig.9: Subsidence in Sendai Plain [4]

Also, damage in the Kanto region due to liquefaction phenomena was significant; approximately 19,000 homes in Ibaraki, Chiba, Saitama, Kanagawa and other prefectures reported damage due to liquefaction. (Fig.10)

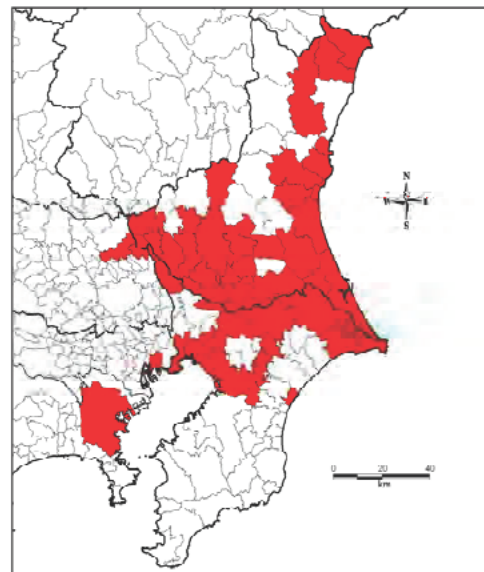

Fig.10: Liquefaction Phenomena in Kanto Area [4]

Meanwhile in the Tokyo metropolitan area, in the immediate aftermath of the earthquake all of the railway lines stopped running, large-scale traffic congestion resulted and roughly 100,000 people were stranded in Tokyo, unable to get home. (Pic.1)



Pic.1: The situation of the Tokyo Metropolitan Government Building (2011/03/11) [4]

In addition to all of this, there was a nuclear accident at the Fukushima No.1 nuclear power plant as a result of the earthquake. In response to this accident, the government has mobilized every resource at its disposal to assess the situation and bring it under control as soon as possible.

3.5 The effects of various disaster prevention countermeasures

The government has thus far implemented a

variety of disaster-prevention countermeasures. While this has produced some definite results in the case of the present disaster, new challenges have also appeared which must be addressed.

(Earthquake Early Warning System/Seismic Warning System)

JMA operates an "Earthquake Early Warning System" that analyses measurement data from seismographs close to an earthquakes epicenter, immediately predicts the estimated time when main ground motion will hit and what intensity scale will be, and then sends out a notification. Bullet trains running at the time of the earthquake were equipped with seismic warning systems that enabled them to stop moving before the main force of the earthquake hit, thus preventing any injuries or deaths.

(Effectiveness of Storm Surge Barriers)

Despite the fact that the storm surge barriers did not stop the tsunami, research reports show that they did reduce its height by roughly 40% and delayed its landfall by around six minutes. Nevertheless, it is clear that there is a limit to how much shore protection facilities, etc., can be relied upon as part of disaster-prevention measures [6].

4. APPROACH THUS FAR TO ANTICIPATING EARTHQUAKES AND TSUNAMIS[7]

4.1 Earthquakes and Tsunamis Anticipated by the Central Disaster Prevention Council

Expert panels convened in the past by the Central Disaster Prevention Council have anticipated ocean trench earthquakes, such as those originating in the Japan trench (where the recent Great East Japan Earthquake was located) and the Kuril-Kamchatka Trench and its environs; Tokai, Tonankai and Nankai megathrust earthquakes; and Tokyo metropolitan area epicentral and Chubu and Kinki region epicentral earthquakes. These panels have estimated damage, outlined scenarios, created strategies and examined countermeasures. The panel establishes models for these anticipated epicentral areas and earthquakes; estimates strong ground motion; estimates casualty numbers, number of buildings damaged, etc., from the estimated size of the vibrations and height of the tsunami; and then, based on the damage estimate results, creates a master plan for lessening the damage caused by an anticipated earthquake and tsunami. Also, an earthquake disaster prevention

strategy containing quantitative disaster reduction targets and specific implementation policies is developed as a preventive measure, and an emergency measure action guide and detailed plan which lay out the role of each government agency, etc., in the event of an earthquake are developed as emergency measures. (Fig.11) (Fig.12)

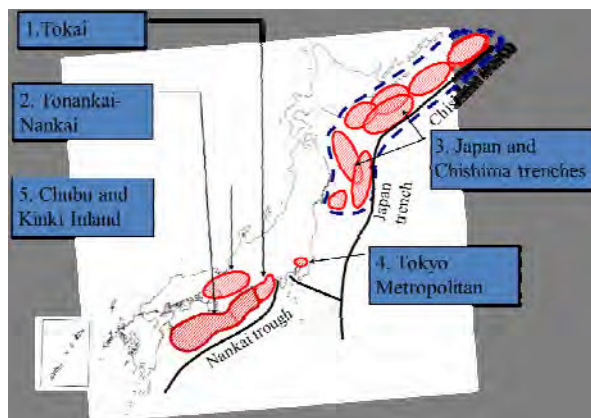

Fig.11: Countermeasures on large earthquakes [8]

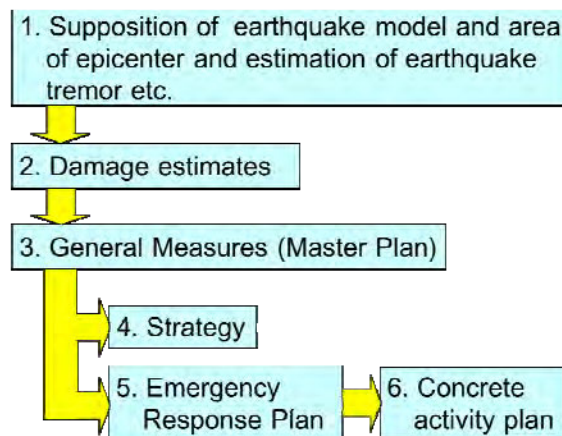

Fig.12 Flow of Countermeasures against Large-scale Earthquake [9]

When envisioning target earthquakes and tsunamis, the expert panel relies on re-creations of earthquakes over the past several hundred years in different areas; they look to see if there are repeating patterns and whether such patterns suggest a high likelihood of an earthquake in the near future in a given area; they then make these anticipated earthquakes and tsunamis the target of their examinations.

The recent earthquake was a magnitude 9.0 earthquake with multiple source regions extending all the way to the southern half of the Japan

Trench, making it one for which it was not possible to confirm data for the past several hundred years. An earthquake like the recent one shows the limits of traditional prediction methods, given that predictions assume that earthquakes and tsunamis will come from areas where they have occurred over the past several hundred years; thus, the expectation was that the epicentral area would be the northern half of the Japan Trench.

4.2 Self-reflection on discrepancies between the recent damages and expectations

The number of the dead or missing is 7 times and of the collapsed houses is about 11 times as much as one of the damage assessments done in 2006 assumed a similar earthquake to the Meiji-Sanriku Earthquake (in 1896). (Table 3) It is necessary to respond seriously to the fact that the results of past predictions of earthquakes and tsunamis differed greatly from the actual earthquake and tsunami that occurred, and to fundamentally reexamine the concepts behind anticipating earthquakes and tsunamis in the future.

Table 3: Disaster Prevention [10]

	Magnitude	Inundation Area	Number of death or missing	Number of collapsed houses
Great East Japan Earthquake	9.0	561 sq km	20,444	112,703
Damage assessment done in 2006 *	8.6	270 sq km	2,700	9,400

* Assumed a similar earthquake to the Meiji-Sanriku Earthquake (in 1896)Source: Cabinet Office

Up until now, consideration was given to a seismic source model where seismic movements and tsunamis that have been recorded up until now could be reproduced, for earthquakes with high incontinence from among the largest earthquakes that Japan has experience over the past few hundred years. This model served to predict the largest earthquake that would occur next. As a result, even for earthquakes that presumably occurred in the past, those for which seismic movements and tsunamis could not be reproduced were deemed as having low accuracy of occurrence, and were not subject to expectation. In terms of the recent damages, it is necessary to

fully self-reflect on the fact that the 869 Jogan Sanriku earthquake, 1611 Keicho Sanriku earthquake, and 1677 Empo Boso-oki earthquake that were thought to have occurred in the past were taken out of consideration.

In such a way, one of the reasons why these earthquakes were not applicable to expectations in initial findings, while being aware that they occurred in the past, is that it is difficult to reproduce an image of the earthquake as a whole. Even if, for example, the entire image of an earthquake is not completely understood, it is necessary in the future to make full use of such information as an applicable earthquake. Even if accuracy is low, it is necessary to give sufficient consideration to historical earthquakes and tsunamis that resulted in overwhelmingly large damages.

Since earthquake and tsunami predictions differed from the actual circumstances, strong ground motion, tsunami height, tsunami range, and submergence area ended up being amplified as compared to prior predictions. In particular, although the estimated submergence area is based on disaster prevention measure materials, such as hazard maps, it cannot be denied that the fact that the recent tsunami was of a tsunami height and submergence area that exceeded predictions was linked to amplification of damages. The hazard maps based on prior predictions served as materials resulting in a sense of security, and as it is possible that this caused damages to be amplified by the recent tsunami that exceeded such predictions, it is necessary to conduct surveys on the inadequacy of hazard maps.

At the same time, when looking at the development of shore facilities, etc., results were exhibited up to the tsunami height subject to design, but when taking into consideration the recent, massive earthquake and the damages caused by the enormous tsunami, it was revealed that there are limitations to disaster prevention measures overly dependent on shore protection facilities, etc.

Expected for tsunami height and earthquake magnitude that were presented by the Japan

Meteorological Agency largely fell below the actual earthquake and tsunami height. After a certain amount of time, the earthquake magnitude and tsunami warning was revised to a level several notches higher. In particular, it can be thought that the impact by the initial tsunami expectation is large. It is possible that the evacuation behavior of residents and evacuation supporters were sluggish due to the original tsunami warning, possibly causing expansion of damages.

With regard to the reason why an earthquake scale and tsunami warning that differed greatly from the actual earthquake and tsunami were issued, in addition to thoroughly determining the cause, it is necessary to conduct detailed survey analysis regarding the kinds of impacts that the announcement of the tsunami warning had on actual evacuation behavior, etc., and to explain this to the public. At the same time, it is also necessary to review recurrence prevention measures based on improving warning systems in anticipation of massive earthquakes as well as policies that make use of offshore tsunami observation data in tsunami warnings, and to promote improvements as quickly as possible.

It is necessary to seriously accept the fact that enormous damages clearly exceeding prior and existing predictions occurred recently, improve past concepts, reexamine everything from prediction of earthquakes and tsunamis to disaster prevention measures, and rebuild a disaster prevention plan for the future.

5. CONCEPT BEHIND EARTHQUAKES AND TSUNAMIS SUBJECT TO DISASTER-PREVENTION MEASURES

5.1 Significance of expected earthquakes and tsunamis

Since the past, for earthquake and tsunami measures, the national and local governments had anticipating earthquakes that are subject to review beforehand, and planned and promoted various disaster-prevention measures in relation to the estimated results of ground motion and tsunamis based on such anticipating earthquake. The recent earthquake and tsunami clearly exceeded prior and existing predictions, but this does not mean that there is no significance in the actual expectations

of earthquakes and tsunamis. It is desirable to conduct sufficient survey analysis on the factors as to why an event that clearly exceeded expectations occurred, continue to carry out necessary expectation of earthquakes and tsunamis, review damage expectations once again, and continue moving forward with disaster prevention measures.

At the same time, natural phenomena are associated with a great deal of uncertainty and thus, it is necessary to make sufficiently known that there are certain limitations to expectations.

5.2 Future concepts behind applicable earthquakes and tsunamis based on the recent earthquake disaster

In order to expect applicable earthquakes and tsunamis, it is necessary to conduct further accurate surveys on the occurrence of earthquakes and tsunamis, etc. by going back as much into the past as possible, analyze historical materials such as ancient documents, carry out surveys on tsunami deposits, and move forward with surveys based on scientific findings, such as surveys on coastal topography.

When doing so, it is necessary to consider conceivable possibilities while also taking into consideration the fact that it is difficult to predict earthquakes and that there is uncertainty in long-term assessment, and to review expected earthquakes and tsunamis by also sufficiently bringing into view the possibility that damages could be amplified.

In addition, when reviewing the necessary disaster prevention measures based on predicted earthquakes and tsunamis, even in cases where measures for such earthquakes and tsunamis are expected to be difficult, it is necessary to establish expected earthquakes and tsunamis without hesitation.

Investigative research such as clarification, etc. of mechanisms behind the occurrence of earthquakes and tsunamis become further necessary. Above all, in order to confirm the large-scale tsunamis that occurred sequentially over the course of several thousand years, the enrichment of comprehensive research based not only on seismology but geology,

archaeology, and history as well, such as surveys on tsunami deposits, geological surveys on sea terraces, surveys on biological fossilization, etc., is important.

Also, in order to accurately comprehend the state of areas near ocean trenches, which are thought to be the cause behind the occurrence of the recent massive tsunami, it is necessary to make further efforts toward promoting research to increase accuracy of expected earthquakes and tsunamis based on seismology, such as by directly observing crustal movement on the ocean floor, conducting surveys on the state of fixation of plates, etc.

The colossal tsunami caused by the recent M9.0 earthquake may possibly have been caused by a so-called “linkage of ordinary earthquakes” and “tsunami earthquake” occurring at the same time. Future progress with the occurrence mechanism behind tsunami earthquakes, survey analysis of linkage between ordinary earthquakes and tsunami earthquakes, and sufficient clarification of the occurrence mechanism behind this are important in expecting future tsunamis associated with trench-type earthquakes.

In particular, in a case where a tsunami earthquake occurs independently, it is possible that there is no large shaking, and a sudden tsunami arises in a state where residents are not alerted to awareness regarding evacuation. As large damages have repeatedly occurred in the past, such as with the 1869 Meiji-Sanriku earthquake and the 1605 Keicho earthquake, particular measures related to warnings and evacuation in anticipation of tsunami earthquakes are necessary.

In regions with nuclear power plants, the impact on such nuclear power plants is extremely large when damages are incurred. Thus, in reviewing predicted earthquakes and tsunamis, it is necessary to conduct further detailed survey analysis regarding the focal area of the earthquakes and wave source area of the tsunamis.

6. CONCEPT BEHIND THESE ANTICIPATED TSUNAMIS IN CONSTRUCTING TSUNAMI MEASURES

6.1 Fundamental concept

In constructing tsunami measures in the future, it is necessary to fundamentally anticipate tsunamis of two levels. The first is tsunamis that are anticipated upon constructing comprehensive disaster-prevention measures that center on resident evacuation. Such tsunamis are anticipated based on ultralong-term surveys on tsunami deposits and observations of crustal movements, etc., and are tsunamis of the largest class that yield enormous damages if they occur, even though the frequency of occurrence is extremely low. The recent Great Tohoku Earthquake is thought to correspond to this category.

The second is tsunamis that are expected upon constructing shore protection facilities, etc. that prevent tsunamis from penetrating inland based on structures such as breakwaters. Compared to tsunamis of the largest class, these tsunamis have a higher frequency of occurrence, and are tsunamis that yield large damages despite being of a low tsunami height.

6.2 Concept behind measures for tsunami heights of the largest class

Based on the occurrence of the recent colossal tsunami and the damages that it caused, it was revealed that there are problems with disaster prevention measures that overly depend on shore protection facilities. It is necessary to construct tsunami measures that anticipate tsunamis of the largest class and the Great Tohoku Earthquake, make protection of residents’ lives the top priority, and to maintain the minimum socioeconomic functions necessary, such as administrative functions, hospitals, etc., regardless of what kind of disaster occurs. As a result, it is necessary to combine land usage, evacuation facilities, disaster prevention facilities, etc., focusing on resident evacuation, and to establish comprehensive tsunami measures that incorporate every possible measure, both hard and soft.

In order for various measures to be diversified/integrated and exhibit effects as tsunami measures, it is necessary to establish a mechanism where an organic linkage among various related plans, such as a regional disaster prevention plan and city plan, can be secured.

In addition, since it is not known what kind of a tsunami will actually hit when it does come, it is necessary to develop the required structure and establish measures so that residents can adopt appropriate evacuation behavior. As a result, with regard to observation and monitoring of tsunamis, presentation of tsunami warnings, communication of tsunami warnings, etc., evacuation guidance, development of evacuation routes and evacuation centers, as well as what kind of information residents received, the type of judgments they made, and how they took action, it is necessary to conduct survey analyses on topics in the recent tsunami and establish sufficient measures in the future. As the recent damages exceeded "damage deterrence measures," it is necessary to strive towards increasing disaster prevention awareness such as through disaster prevention education and disaster prevention training for residents and public administration based on the necessity of "damage abatement measures" that do not broaden damages as much as possible.

In particular, it is important to conduct reviews on what kinds of information can be helpful in residents' evacuation behavior, how communication means should be thought of, such as the enhancement of the government's disaster prevention radio and use of mobile phones, and establish the necessary measures in conjunction with relevant agencies.

Furthermore, in the case that nuclear power plants, municipal government buildings, which serve as a base during disasters, and disaster prevention bases such as police stations and fire departments become damaged, the impact of such damages is enormous. As a result, it is particularly important to consider all possible measures to ensure tsunami measures for these important facilities.

6.3 Tsunami measures based on shore protection facilities for tsunamis of high frequencies
Shore protection facilities, etc., which have been developed since the past, are based on anticipation of tsunamis of relatively high frequency, and they have exhibited results for damage deterrence of tsunami heights up to a certain level. However, due to the recent occurrence of a tsunami largely

exceeding the designed tsunami height, although certain effects were seen such as reduction of water level, delay in the tsunami arrival time, etc., many shore protection facilities, etc. were damaged, and enormous tsunami damages were incurred in hinterlands.

Significantly increasing the tsunami height applicable to development of shore protection facilities, etc. is not realistic in terms of the necessary costs for facility development and the impacts on the shore environment and usage. However, from the perspectives of protection of human life, protection of residents' property, stabilization of local economic activities, and securing efficient industrial bases, it is desired for development of shore protection facilities, etc. for tsunamis of a relatively high frequency and certain height to continue progressing.

With regard to shore protection facilities, it is necessary to promote technological development of structures where facilities can exhibit effects tenaciously even in cases where the tsunami height exceeds the designed height, and to maintain such facilities.

7. SUMMARY

In Japan, the possibility of a large-scale earthquake and tsunami is constant and everywhere; this is an inescapable fact that has been and will always remain true.

In order to prepare for these earthquakes and tsunamis, Japan is comprehensively and systematically advancing disaster-prevention countermeasures based on the "Disaster Countermeasure Basic Act" as well as upgrading earthquake disaster prevention facilities in accordance with a five year plan based on the "Act on Special Measures concerning Earthquake Disaster Management."

Also, in June of this year, Japan established the "Tsunami Countermeasures Promotion Act" in order to take all possible measures against tsunamis so as to avoid repeating the experience of the Great East Japan Earthquake. To protect the lives, health and property of Japan's residents from the harm of tsunamis, Japan is working to raise basic awareness about tsunamis and is working comprehensively and effectively on tsunami

countermeasures geared towards recovery and rebuilding.

Soft infrastructural measures, such as strengthening tsunami observation systems, promoting study and research, forecasting damage resulting from tsunamis, implementing disaster-prevention education and training, and creating evacuation plans, as well as hard infrastructural measures, such as upgrading shore protection facilities, promoting urban development focused on tsunami countermeasures, and ensuring the security of facilities handling hazardous materials are being established. Other efforts include promoting international cooperation in tsunami countermeasures and establishing a "Tsunami Disaster Prevention" day.

Furthermore, the "Basic Policy on Great East Japan Earthquake Reconstruction," based on the Great East Japan Earthquake Reconstruction Basic Act, was adopted in July of this year. In order to rejuvenate the society and economy of the affected areas, help residents rebuild their lives and revitalize the country, Japan must devote itself completely to recovering from the Great East Japan Earthquake and push ahead with forward-looking initiatives; because the full scope of Japan's task in overcoming the national hardships created by the Great East Japan Earthquake is now clear. It is incumbent on every member of society that we work together and do our utmost to overcome this challenge.

This paper has focused on the Expert Panel's interim report concerning the lessons learned from the Great East Japan Earthquake and the future direction of earthquake and tsunami countermeasures. The final report of the Expert Panel is expected in the fall of this year, and based on its recommendations, fundamental revisions will be made in the Basic Disaster Prevention Plan,

which is the document laying out Japan's essential policies and initiatives on disaster-prevention countermeasures. Also, study will continue on ocean trench, ultra-wide and super-massive earthquakes comprised of interlinking Tokai, Tonankai and Nankai megathrust earthquakes in the Nankai trough, where concern exists about future earthquakes.

Finally, I want to offer my sincerest prayers for those who lost their lives in the disaster, and I resolve to work, with renewed determination, to advance the cause of disaster prevention.

8. REFERENCE

1. White Paper on Disaster Management 2011
2. The data of Earthquake Research Institute, University of Tokyo
3. The data of Meteorological Research Institute
4. The handouts of the committee for technical investigation on Earthquake and Tsunami Countermeasures Based on the Lessons of Great East Japan Earthquake (1st round)
5. Website of the office of the Prime Minister
6. The handouts of the committee for technical investigation on Earthquake and Tsunami Countermeasures Based on the Lessons of Great East Japan Earthquake (3rd round)
7. Expert Panel on Earthquake and Tsunami Measures Using the Great Tohoku Earthquake as a Lesson Interim Report - Fundamental Concepts for Future Tsunami Prevention Measures – June 26, 2011, Cabinet Office
8. "Disaster management in Japan" Cabinet Office, 2011
9. The data of Cabinet Office
10. The handouts of the committee for technical investigation on Earthquake and Tsunami Countermeasures Based on the Lessons of Great East Japan Earthquake (2nd round)

Strong Motion and Earthquake Response Records of the 2011 off the Pacific Coast of Tohoku Earthquake

by

Kataoka Shojiro¹, Nagaya Kazuhiro¹, Matsuoka Kazunari² and Kaneko Masahiro³

ABSTRACT

This paper describes strong ground motion and dynamic response of a levee and a viaduct recorded during the 2011 off the Pacific coast of Tohoku earthquake. Iseismal maps have been produced using the strong motion records for developing vulnerability functions of various facilities. Nonlinear response analyses have been carried out for simulating dynamic response of a levee and a viaduct during the earthquake.

KEYWORDS: Levee, Nonlinear Response Analysis, Strong Motion, the 2011 off the Pacific Coast of Tohoku Earthquake, Viaduct

1. INTRODUCTION

The largest earthquake in recorded history in Japan started its rupture on March 11, 2011 at 14:46:18 in JST. Japan Meteorological Agency (JMA) reported JMA magnitude, M_J of the earthquake was 7.9 within 3 minutes. The moment magnitude, M_w was then calculated using data recorded by domestic broadband seismographs but in vain; almost all the data exceeded recording capacity of the seismographs [1].

JMA reported a revised M_J of 8.4 at 16:00 and then M_w of 8.8, which was estimated using data from broadband seismographs all over the world, at 17:30. The M_w was revised to 9.0 on March 13 after a detailed analysis of the rupture process. It was found to include three major ruptures and the maximum slip was estimated to be 40m as shown in Fig. 1 [2].

Challenges left after the earthquake, named the 2011 off the Pacific coast of Tohoku Earthquake by JMA, are so enormous that even its magnitude was hard to be determined as mentioned above. One of the important

challenges is developing methods for effective and economical disaster mitigation against such great earthquakes. In order to gain a foothold for this great task, preliminary analyses were carried out using the strong motions and earthquake response recorded during the devastating earthquake.

2. STRONG MOTION

2.1 MLIT Seismograph Network [3]

Ministry of Land, Infrastructure, Transport and Tourism (MLIT) has been administered the Seismograph Network that consists of more than 700 stations with accelerometers on ground surface since 1997. The stations were installed with intervals of 20 to 40 km along rivers and national highways administered by MLIT. The observed data (PGA, spectrum intensity (SI), and JMA instrumental seismic intensity) are sent to National Institute for Land and Infrastructure Management (NILIM) and opened to the public at NILIM website as shown in Fig. 1 [3].

Fig.2 shows time histories of ground acceleration observed at KSN, OSK, and IWS stations. Two major wave groups at KSN and OSK correspond to the first two ruptures, which occurred near the epicenter, while the peak acceleration at IWS corresponds to the third rupture, which occurred about 200 km south of the epicenter [2]. The data logger of KSN station was installed on the second floor of a two-story building attacked by the tsunami (Photo 1). A little water remained inside of the data logger when it was opened on April 6th.

Fig. 3 compares acceleration response spectra of the ground motion shown in Fig. 2 with those

¹ Senior Researcher, Earthquake Disaster Prevention Division, National Institute for Land and Infrastructure Management, 1 Asahi, Tsukuba 305-0804, Japan

² Researcher, ditto

³ Head, ditto

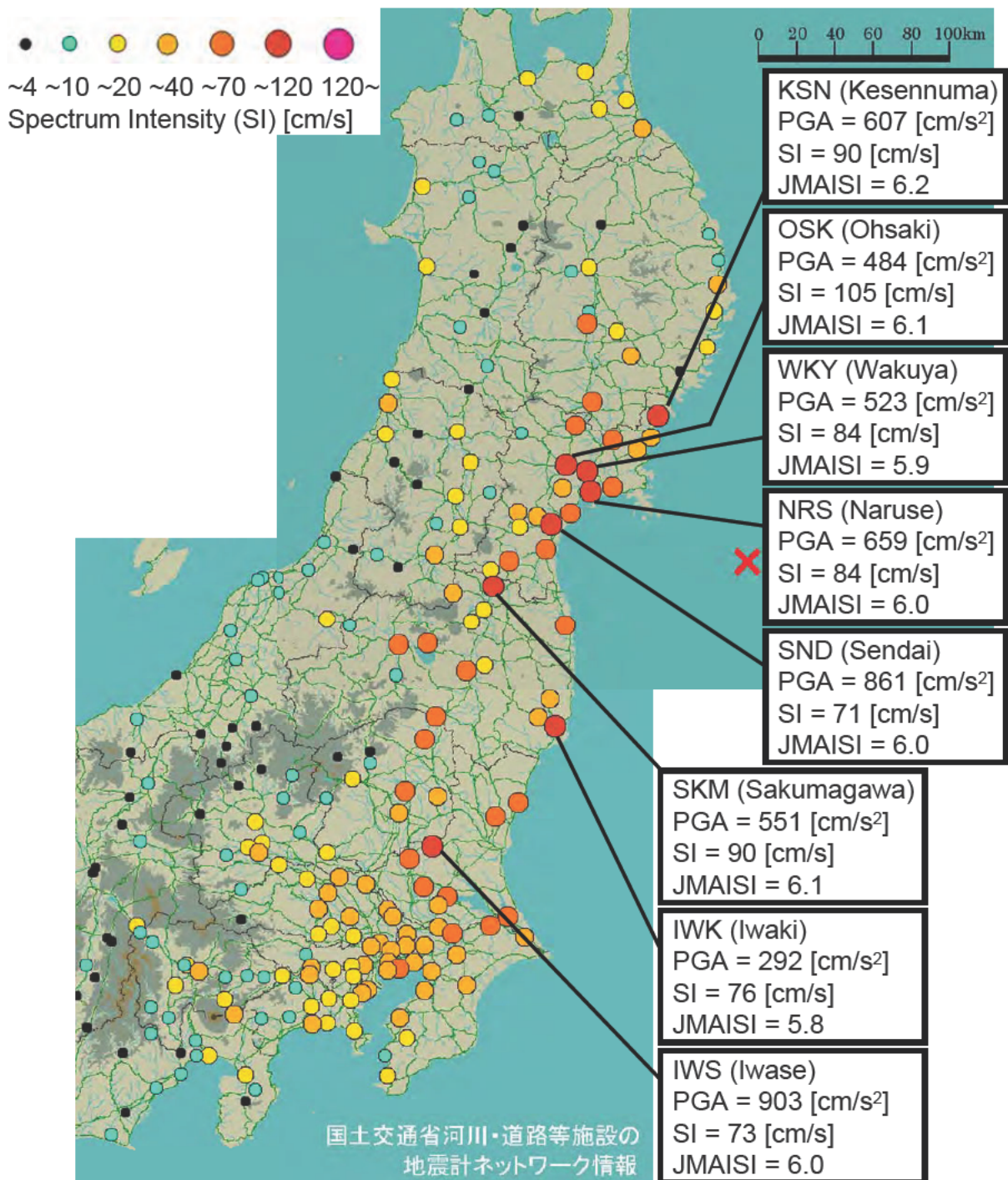

Fig.1 Map of SI observed by MLIT Seismograph Network [3]. PGA, SI, and JMA instrumental seismic intensity are shown for the sites of which SI was 70 [cm/s] or larger. PGA and SI are calculated by synthesizing two horizontal components.

observed at Takatori Station and JMA Kobe Marine Observatory during the 1995 Kobe earthquake. The two response spectra of the 1995 Kobe earthquake are mostly larger than the

other three over the natural period from 0.1 to 10 [s]; this may account for the difference of the damage due to the ground motion (not including tsunami) between these two earthquakes.

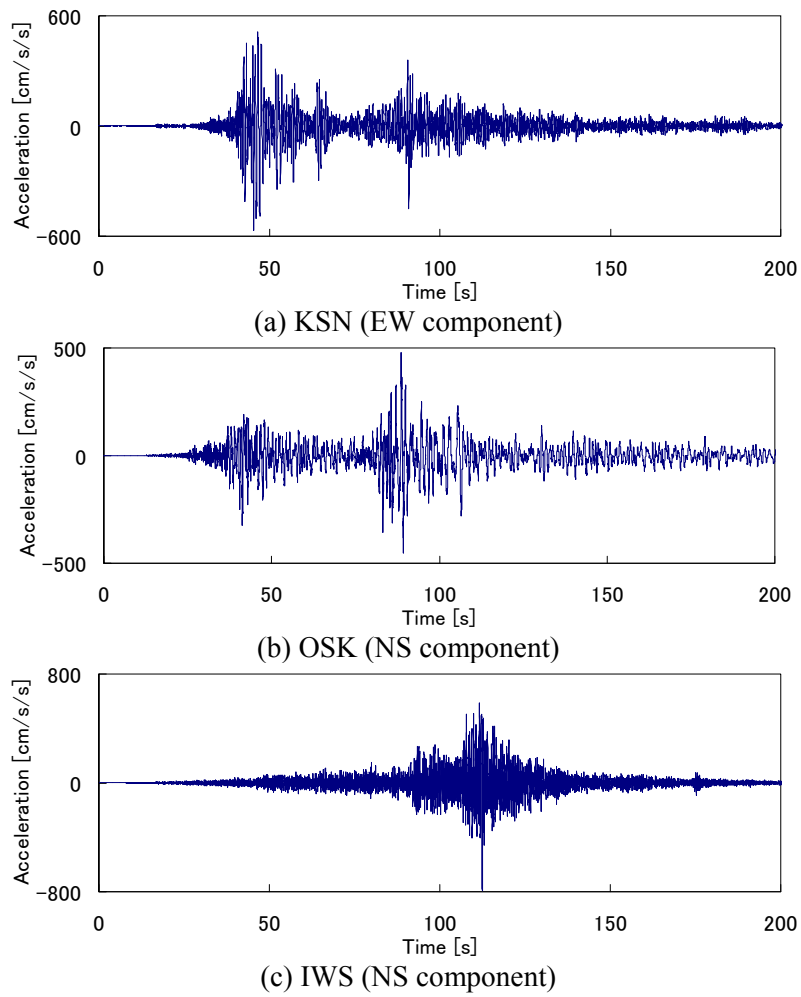

Fig.2 Ground acceleration observed at KSN, OSK, and IWS stations.



Photo 1 Data logger of KSN station that was attacked by tsunami.

2.2 Isoseismal Maps

Isoseismal maps have been produced for PGA, SI, and JMA instrumental seismic intensity by interpolation of strong motion records obtained by MLIT, JMA, and National Research Institute for Earth Science and Disaster Prevention

(NIED). Fig.4 shows the SI isoseismal map as an example. The strong motion observation networks of NIED are known as K-NET and KiK-net [4]. These maps will be employed for developing vulnerability functions of various facilities.

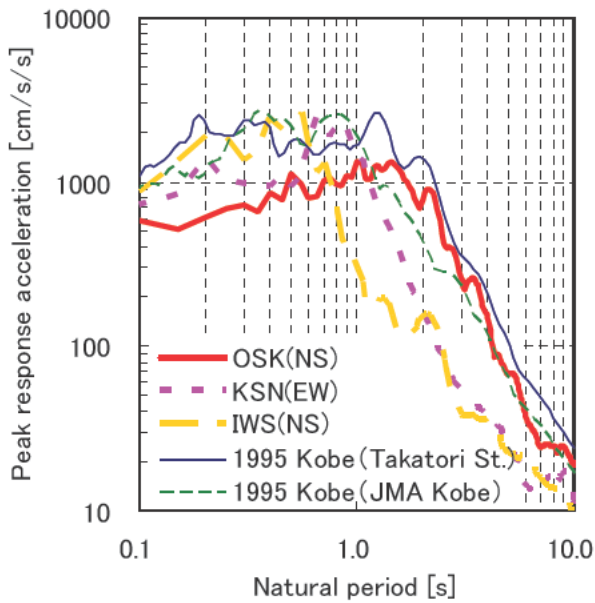

Fig.3 Acceleration response spectra of the strong motion observed at KSN, OSK, and IWS compared with those at Takatori Station and JMA Kobe Observatory of the 1995 Kobe earthquake.

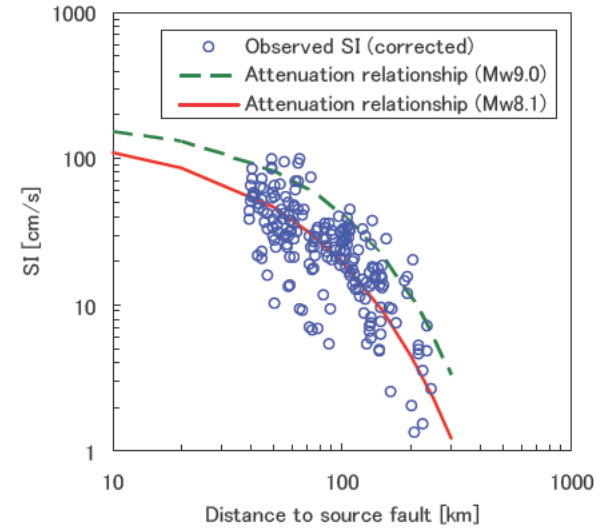
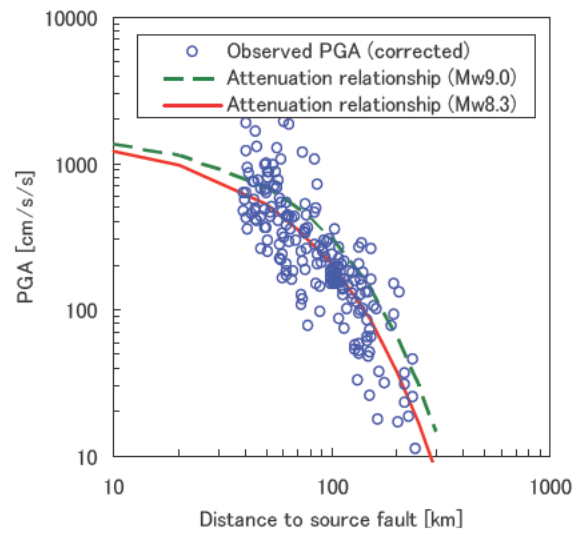

Fig.5 Observed ground motion intensities compared with attenuation relationships [5], which are found to give least errors with the observed PGA and SI when M_w 8.3 and 8.1 are assumed, respectively.

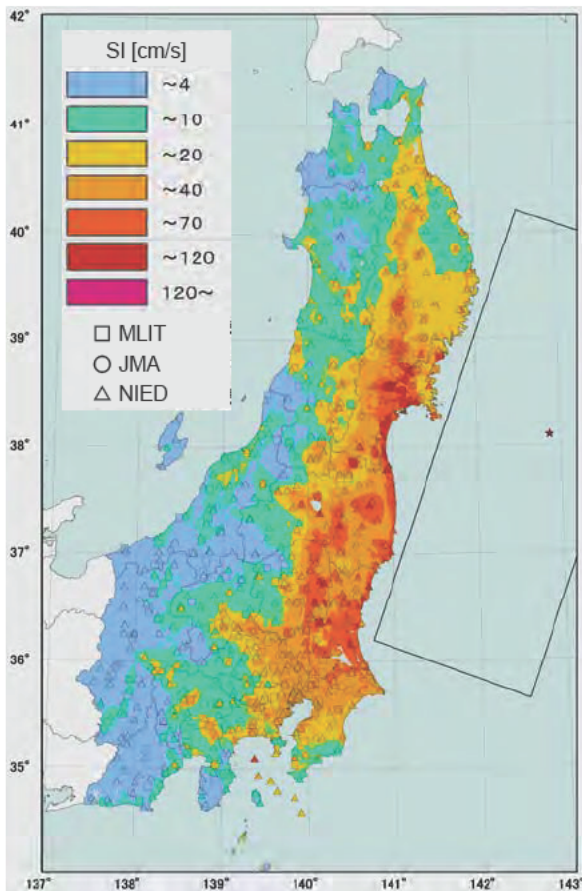

Fig.4 SI isoseismal map based on strong motion records observed by MLIT, JMA, and NIED.

2.3 Ground Motion Attenuation

Fig.5 compares observed ground motion intensities with attenuation relationships [5]. It can be seen that the attenuation relationships overestimate both PGA and SI when M_w 9.0 is assumed. The attenuation relationships are found to have least misfit with the observed PGA and SI when M_w 8.3 and 8.1 are assumed, respectively. Though very large PGAs were observed at several stations within 100km from the source fault, the ground motion during the 2011 off the Pacific Coast of Tohoku Earthquake

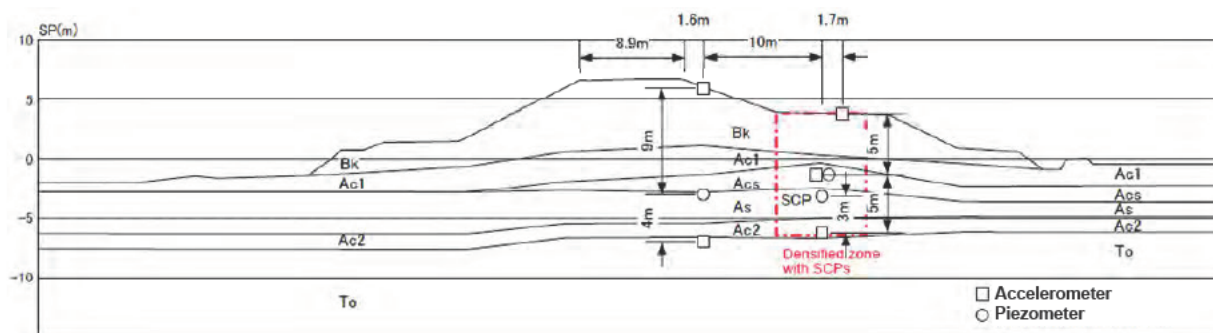

Fig.6 Locations of accelerometers and piezometers at Nakashimo station.



Photo 2 Nakashimo station before (left: 2008) and after (right: April 4, 2011) the earthquake. Tsunami inundation height was about 1m in this area.

in general was not very large considering its magnitude.

3. EARTHQUAKE RESPONSE OF A LEVEE

Fig.6 shows locations of accelerometers and piezometers at Nakashimo station, right-bank of Naruse river, Miyagi prefecture. The sensor arrays were installed at the berm, where liquefaction strength had been improved by the sand compaction pile (SCP) method, and near the crown, where no liquefaction remediation had been conducted.

Time history records of ground acceleration and pore water pressure were obtained at the sensor array near the crown during the 2011 off the Pacific of Tohoku Earthquake, while no records were obtained at the berm. The station was attacked by tsunami, as shown in Photo 2, of

which inundation height was estimated about 1m from the trace of water surface on the inside wall of the instrument shed.

A computer code for 1-D effective stress analysis [6] was employed for the simulation of the earthquake response of the levee. Fig.7 shows the observed motion at the base layer, which was used as an input motion, and the observed and simulated motions at the crown. Though short period component of the simulated motion is somewhat smaller than the observed one, the entire waveform was reproduced well. Observed and simulated time histories of excess pore water pressure are also compared in Fig. 8. Hydrodynamic pressure and dissipation of pore water pressure were not reproduced at all; freezing soil sampling and 2-D simulation may be required for improving the agreement between observed records and the effective stress analysis.

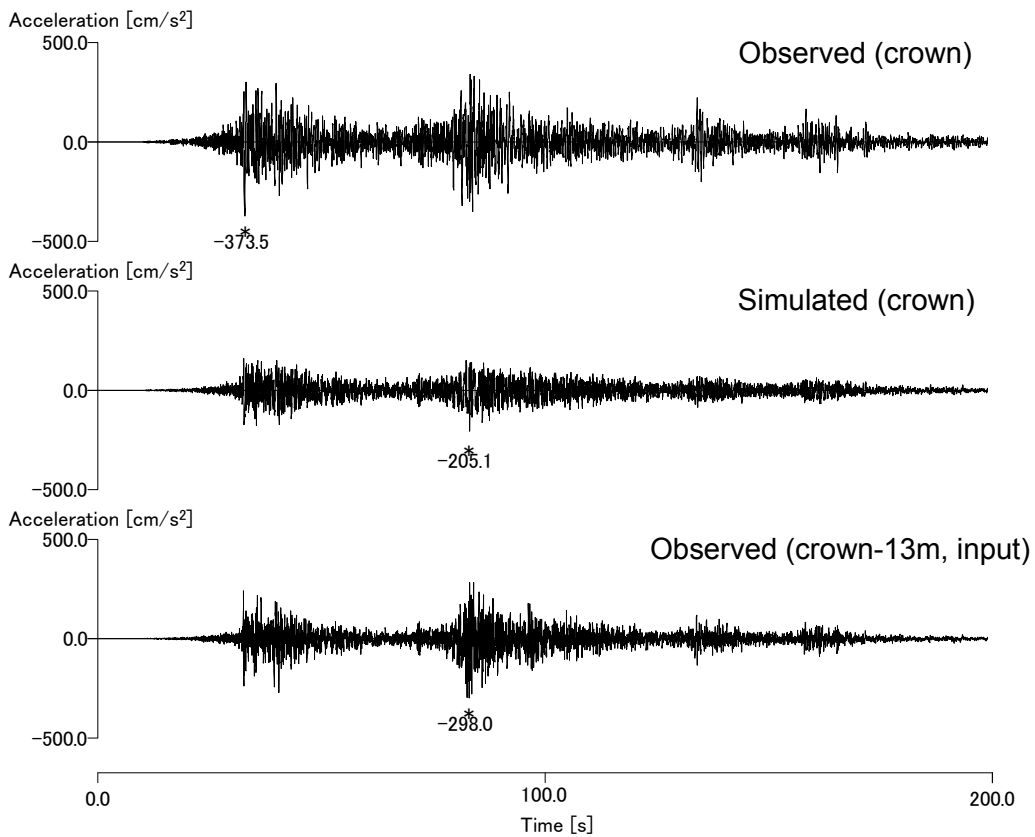

Fig.7 Time history records observed at Nakashimo station during the 2011 off the Pacific of Tohoku Earthquake (NS component, top: crown, bottom: base layer) compared with a simulated motion at the crown by the effective stress analysis (middle).

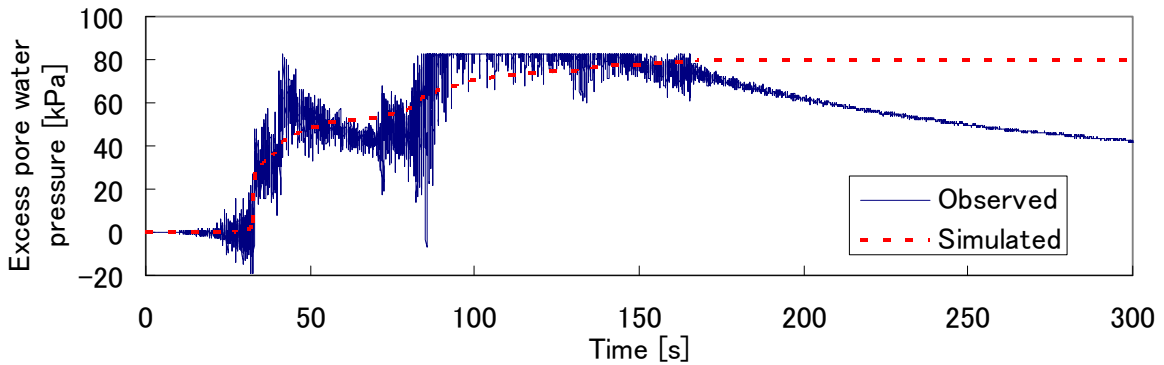

Fig. 8 Observed excess pore water pressure compared with the simulated one.

4. EARTHQUAKE RESPONSE OF A VIADUCT

Fig.9 shows section of Yamada viaduct, 470.7m long with two 4-span continuous steel box girders, using multi-layered rubber bearings. Ground motion and earthquake response of the viaduct were recorded by the accelerometers on

the ground surface, top of P3, and the girder. The accelerograms at the ground surface are shown in Fig.10.

Detailed investigation revealed that side blocks, which had been installed for restricting movement of bearings in the transverse direction,

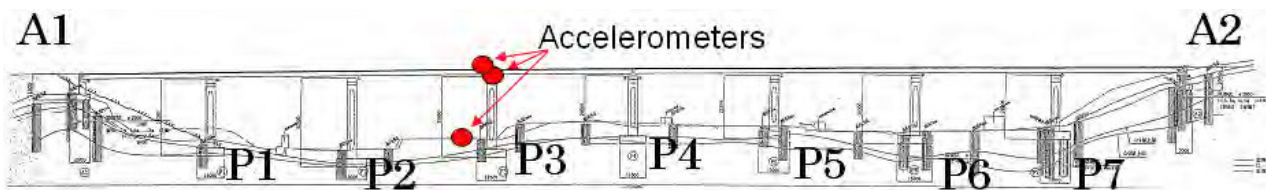

Fig.9 Section of Yamada viaduct with locations of accelerometers.

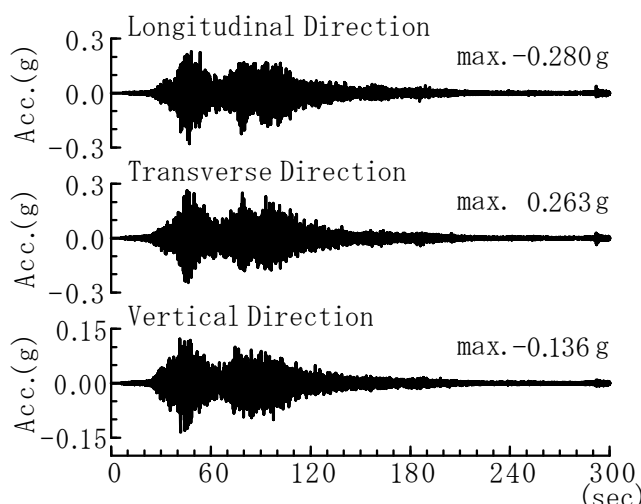

Fig.10 Accelerograms recorded at ground surface under Yamada viaduct.



Photo 3 Yamada viaduct and its bearing. The top plates of bearings were scraped by the side blocks.

scraped top plates of the bearings. Therefore, a dynamic response analysis of the viaduct was carried out taking the contact between the bearings and the side blocks into account (Fig.11).

Figs.12 and 13 compare the observed records with the computed responses. Longitudinal component of the girder and transverse component of the top of P3 are not reproduced

well. We have been investigating the reason that causes the difference between observed and computed responses.

5. CONCLUDING REMARKS

Results of preliminary analyses using the strong motion and earthquake response records obtained during the 2011 off the Pacific of Tohoku Earthquake were presented. Development of

methods for effective and economical disaster mitigation against great earthquakes is a pressing issue. NILIM has been intent on maintenance of the strong earthquake motion observation systems and utilizing the observed records for seismic design and earthquake disaster mitigation. We will be working on further development of the observation systems and improvement of the data utilization.

The strong motion records obtained by JMA, NIED, JR west and MLIT were used in this paper.

6. REFERENCES

1. JMA website: http://www.seisvol.kishou.go.jp/eq/tsunami_kaizen_benkyokai/benkyokai1/si
2. Yoshida, Y., Ueno, H., Muto, D. and Aoki, S.: Source process of the 2011 off the Pacific coast of Tohoku Earthquake, MIS036-P3, 2011.
3. NILIM website: <http://www.nilim.go.jp/japanese/database/nwdb/index.htm>
4. NIED website: <http://www.kyoshin.bosai.go.jp/kyoshin/>
5. Kataoka, S., Satoh, T., Matsumoto, S. and Kusakabe, T.: Attenuation relationships of ground motion intensity using short period level as a variable, *Proc. JSCE, A*, Vol. 62, No. 4, pp. 740-757, 2006.
6. Yoshida, N. and Towhata, I.: YUSAYUSA-2 SIMMDL-2 Theory and usage (version 2.10), 2005.

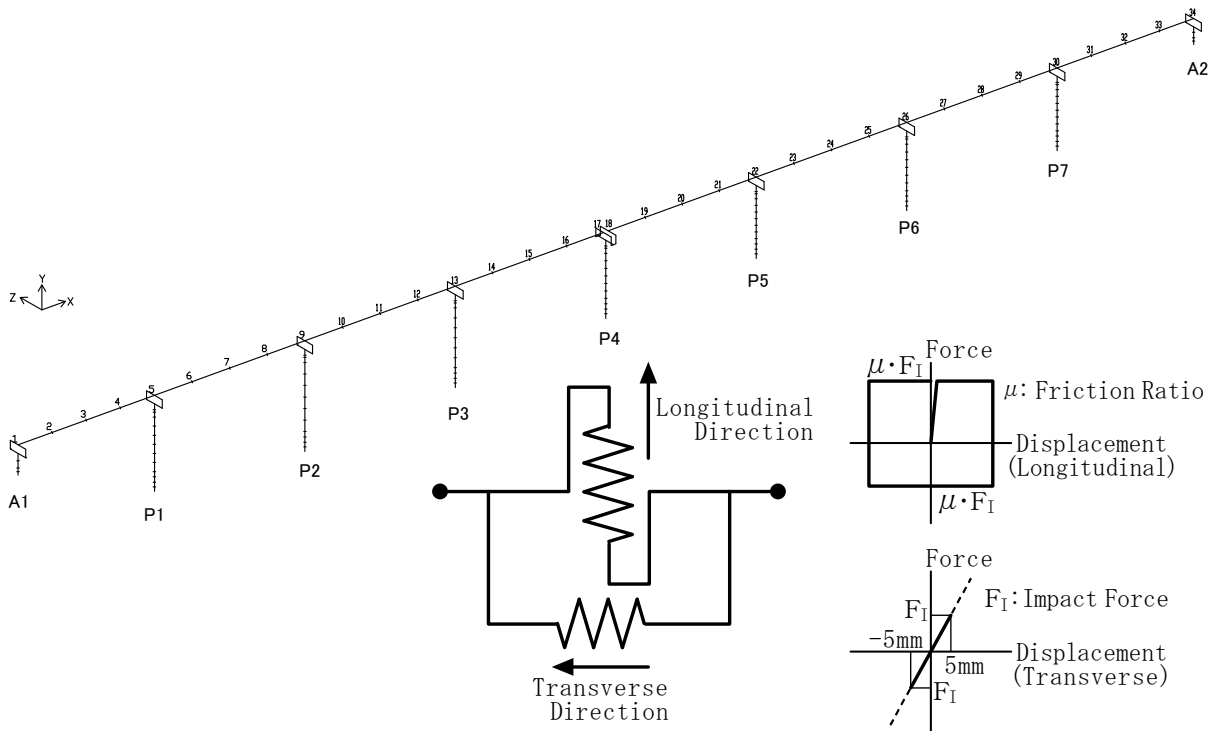

Fig.11 Perspective (top) and force-displacement relationships of bearings with side blocks (bottom) of the analytical model of Yamada viaduct. A sway-rocking model was employed for foundation-ground system.

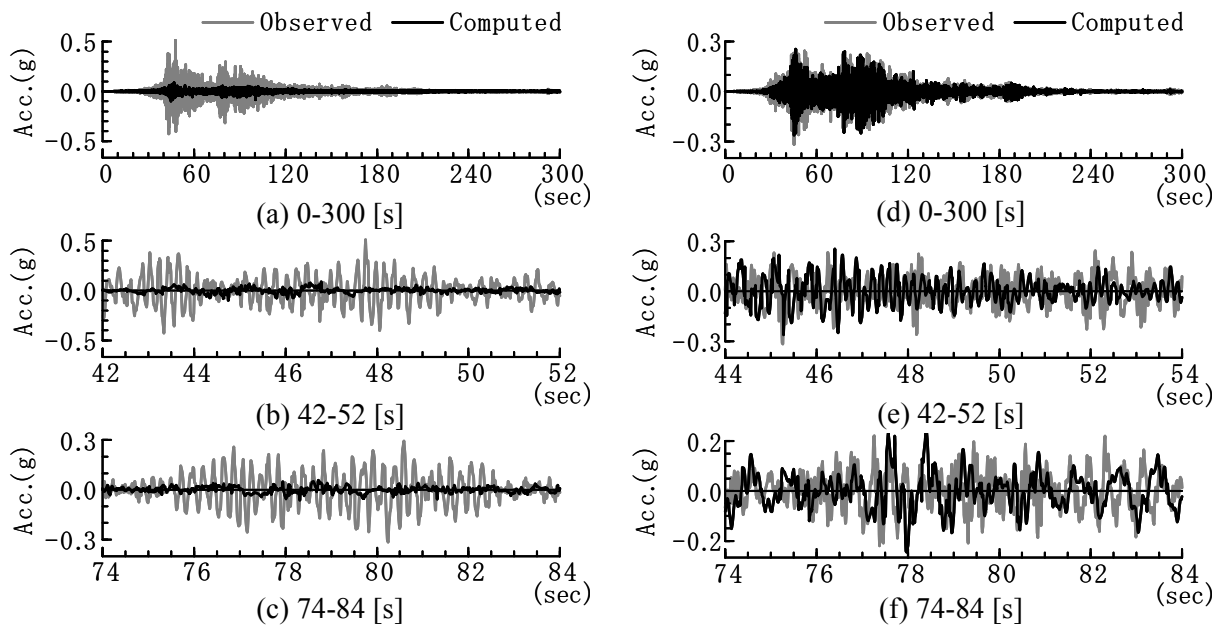

Fig.12 Comparison of the observed and computed earthquake responses of the girder above P3.
 (a)(b)(c): Longitudinal direction; (d)(e)(f): Transverse direction.

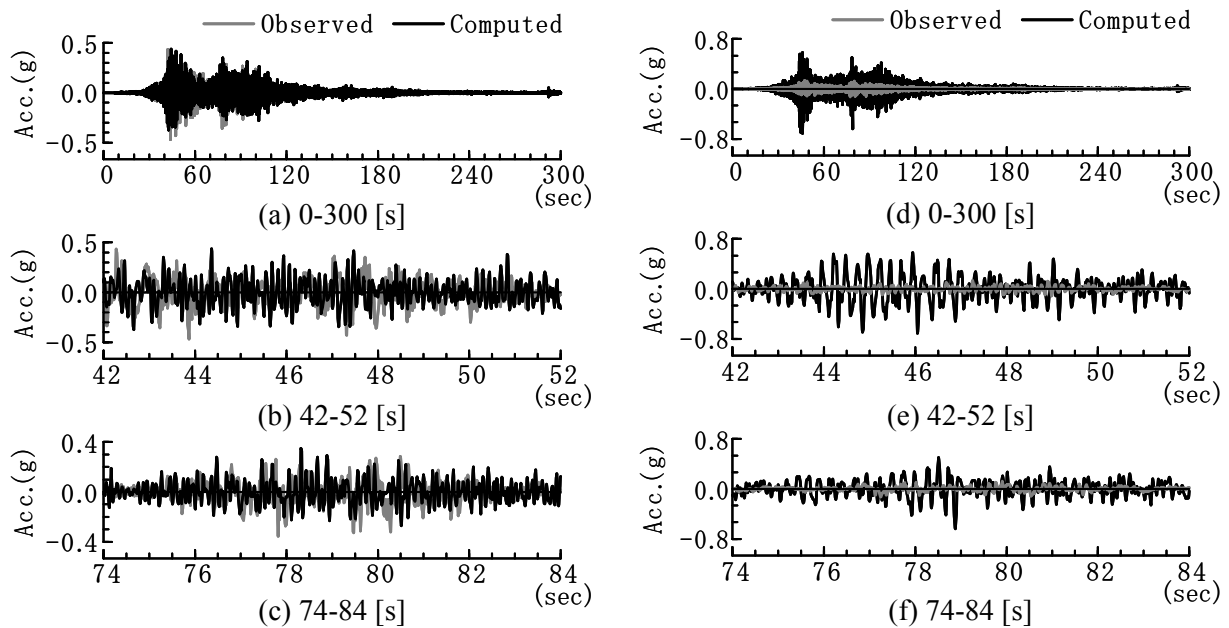

Fig.13 Comparison of the observed and computed earthquake responses of the top of P3.
 (a)(b)(c): Longitudinal direction; (d)(e)(f): Transverse direction.

Crustal deformation and fault model of the 2011 off the Pacific coast of Tohoku Earthquake

by

Tetsuro Imakiire^{1*}, Mikio Tobita², Shinzaburo Ozawa³, Takuya Nishimura³,
Hisashi Suito⁴, Tomokazu Kobayashi⁴

ABSTRACT

This paper reports the overview of the crustal deformation caused by the 2011 off the Pacific coast of Tohoku Earthquake (hereafter referred as "the Tohoku Earthquake"), detected by GEONET, the GPS continuous observation system operated by GSI. We found very wide area of Japanese Islands was remarkably affected by the crustal deformation caused by the main shock of the Tohoku Earthquake, from Hokkaido to Kinki district. We estimated the geometry of the seismogenic fault of the Tohoku Earthquake, as well as the slip model on the plate boundary between the Pacific plate and the North American plate, from the crustal deformation data. The length of the fault is estimated longer than 400 km from off Iwate prefecture in the north to off Ibaraki prefecture in the south. The largest slip estimate on the plate boundary is more than 56 m at the off Miyagi region near the Japan trench. The postseismic crustal deformation is also observed by GEONET. This means slow postseismic slip is ongoing along the plate boundary around the main fault zone.

KEYWORDS: Crustal Deformation, Fault Model, GEONET, Plate Boundary, Slip distribution, The 2011 off The Pacific Coast of Tohoku Earthquake

1. OVERVIEW OF THE EARTHQUAKE

The 2011 off the Pacific coast of Tohoku Earthquake (hereafter referred as "the Tohoku Earthquake") broke out on 14:46, March 11, 2011. It is the largest earthquake, of which magnitude is 9.0 (by JMA), among all earthquakes recorded in the history of seismic observation in Japan. The highest intensity, VII (JMA scale) was recorded at Kurihara City,

Miyagi prefecture. The epicenter locates at off shore of Miyagi prefecture, where large plate boundary earthquakes, of which magnitude is 7 to 8 but not larger than 8.5, have occurred repeatedly. The Tohoku Earthquake generated a disastrous tsunami hitting the wide area of the Pacific coast from Hokkaido to Honshu causing great damages. Meiji-Sanriku Earthquake (M8_1/4), which occurred in 1896 at the neighboring area to the Tohoku Earthquake's source region, is known as "tsunami earthquake" and caused more than 22,000 casualties. The Tohoku Earthquake caused nearly the same number of dead and lost people.

2. COSEISMIC CRUSTAL DEFORMATION

Significant crustal deformation caused by the Tohoku Earthquake was detected by GEONET, the continuous GPS observation network operated by GSI. Figure 1 shows the horizontal movement, and Figure 2 shows the vertical movement of GEONET sites in the northeastern Japan. (GSI, 2011a)[1] The maximum movement is recorded at "Oshika" site in the Ishinomaki city, Miyagi prefecture. "Oshika" horizontally moved toward southeast by east about 5.3 meter, as much as vertically subsided about 1.2 meter.

Figure 3 shows the contour map of horizontal movements. (GSI, 2011b)[2] It is notable that a very wide area around the Tohoku and Kanto region is affected by the crustal deformation by the Tohoku earthquake. The GEONET sites in Iwate prefecture at the north, Yamagata

¹ Principal Researcher, Geography and Crustal Dynamics Research Center, Geospatial Information Authority of Japan, Tsukuba-shi, Ibaraki-ken 305-0811 Japan

² Director of Crustal Deformation Research Division, ditto

³ Senior Researcher of Crustal Deformation Research Division, ditto

⁴ Researcher of Crustal Deformation Research Division, ditto

prefecture at the west, and Ibaraki prefecture at the south, moved more than 1 meter. Even in Tokyo metropolitan area, about 0.2m horizontal movement is observed.

Figure 4 shows the contour map of vertical movement. (GSI, 2011b) It is remarkable that all places along the Pacific coast line in the Tohoku and Kanto region subsided coseismically. The Oshika peninsula, the nearest place to the epicentric area, subsided more than 1 meter. Several tens centimeter subsidence is recorded at many sites from Miyagi to Ibaraki prefecture coast line, where are affected by high tide after the earthquake..

3. FAULT MODELS

We constructed a fault model using coseismic surface displacement data observed by GEONET. A preliminary fault model which consists of two rectangular faults with a uniform slip in an elastic half-space is shown on Figure 5. The parameters of these faults are estimated, based on the formula introduced by Okada (1985). [3]. This figure shows that a total major rupture length reaches about 380 km with a fault width of 90-130 km. (Northern segment: about 180 km long/ Southern segment: about 180 km long). A reverse fault motion is inferred. Slip amounts of northern segment and southern one are estimated to be about 25 m and about 6 m, respectively. A total moment magnitude is 8.9. (Northern segment: M_w 8.8 / Southern segment: M_w 8.2)

Figure 6 shows a distributed slip model using coseismic surface displacement data observed by GEONET. (GSI, 2011b) We assumed that the coseismic slip occurred along the plate boundary between the Pacific Plate, which is subducting from east, and the North American plate, where the Tohoku region locates. The slip is estimated by the geodetic inversion based on the method of Yabuki and Matsu'ura (1992). [4]. The slip area, where the slip estimated larger than 4 m, extends more than 400 km from north to south, or nearly 450 km in the major axis along the Japan trench, as well as the width is about 200 km from west to east. The largest slip, estimated at near the epicenter, is about 27 m. (Ozawa et al., 2011)[5] Total amount of the energy coseismically

released, or seismic moment based on this slip model, is 3.90×10^{22} Nm, equivalent to the moment magnitude (M_w) 9.0, assuming the rigidity as 40 GPa. This moment magnitude value is consistent to other results of the estimation based on seismic wave inversion or tsunami inversion analysis.

Figure 7 shows an advanced slip distribution model using GEONET data and seafloor crustal deformation data observed by Japan Coast Guard. (GSI, 2011b) The horizontal movement observed at "Miyagi-1" seafloor site is as large as 24m, and vertical movement there is about 3 m uplift. It is notable that the center of the slip area is estimated nearer to the Japan trench, or more eastward, compared with the previous model. Furthermore, the estimated maximum slip is more than 56 m, much larger than previous estimation. This extremely large slip means that the plate boundary around this area has been stuck very firmly before the earthquake, and has been accumulating strain energy for a long time.

4. POSTSEISMIC CRUSTAL DEFORMATION

GEONET reveals remarkable crustal deformation is ongoing around the Tohoku and Kanto region after the Tohoku Earthquake. Figure 8 shows the time series of the crustal deformation at the "Yamada" site, which locates on the coast of Iwate prefecture, after the Tohoku Earthquake. (GSI, 2011b) Horizontal movement toward southeast by east after the mainshock exceeds 50 cm on the time point at the end of June 2011.

Figure 9 shows postseismic horizontal (a) and vertical (b) movement vectors around northeastern Japan. (GSI, 2011b) The pattern of the horizontal movement vectors toward east to southeast means that crustal block on the North American plate, where Tohoku region locates, is moving eastward, overriding onto the Pacific plate, even after the Tohoku earthquake. However, when we look into the detail of the crustal movement pattern, we can note a slight difference between the coseismic one and postseismic one. Although all GEONET sites subsided coseismically, several sites in Miyagi

prefecture and certain sites around Choshi have been uplifting after the earthquake.

Figure 10 shows the slip distribution model for the postseismic crustal deformation. (GSI, 2011b) Most significant feature of this slip model is that the center of slipping area is locating a little westward from the center of coseismic slip area. This means that postseismic slip along the plate boundary occurs mainly deeper zone compared with coseismic rupture zone. The geomorphological evidence, such as coastal terraces, shows that the coastal area of the Tohoku district has been uplifting for the long term. However, geodetic observation including leveling survey from one hundred years ago, tidal observation for several tens years, and GPS observation, shows that the Pacific coast of the Tohoku region has been subsiding before the Tohoku Earthquake. There was a hypothesis that a coseismic uplift caused by a great interplate earthquake would exceed the inter-seismic subsidence. However, the concerned area has been subsided by the Tohoku Earthquake. Another hypothesis explains that postseismic slip would widely spread into the deeper zone of plate boundary after a great earthquake, and that postseismic slip would be the main reason of inter-seismic uplift. We would be able to decide whether this explanation is appropriate or not, following the crustal deformation observation for several years.

5. SUMMARY

The 2011 off the Pacific coast of Tohoku Earthquake is the largest earthquake in the history of seismic observation in Japan. Detected coseismic crustal deformation is remarkably large. Maximum horizontal movement, 5.3m, and subsidence of 1.2m is recorded at Ishinomaki. The slip distribution model derived from crustal deformation data shows extremely large slip, larger than 56 m, exists at the shallow plate boundary zone near the Japan trench. Remarkable postseismic crustal deformation has been ongoing since the mainshock. Even though slight uplift is observed at a part of subsided area, the rate of uplifting there is not as large as expected.

6. REFERENCES

1. Geospatial Information Authority of Japan, Crustal deformation associated with the 2011 off the Pacific coast of Tohoku Earthquake on March 11, 2011, <http://www.gsi.go.jp/chibankansi/chikakukansi40005.html>, 2011a, (in Japanese)
2. Geospatial Information Authority of Japan, Crustal Movements in the Tohoku District, *Rep. CCEP, Vol.86, 2011b* (in press), (in Japanese)
3. Okada, Y., Surface deformation due to shear and tensile faults in a half-space, *Bull. Seism. Soc. Am.*, *75*, 1135-1154, 1985.
4. Yabuki, T. & Matsu'ura, M., Geodetic data inversion using Bayesian information criterion for spatial distribution of fault slip. *Geophys. J. Int.* *109*, 363-375, 1992
5. Ozawa, S., T. Nishimura, H. Suito, T. Kobayashi, M. Tobita and T. Imakiire, Coseismic and postseismic slip of the 2011 magnitude-9 Tohoku-Oki earthquake, *Nature*, *475*, 373-376, [doi:10.1038/nature10227](https://doi.org/10.1038/nature10227), 2011

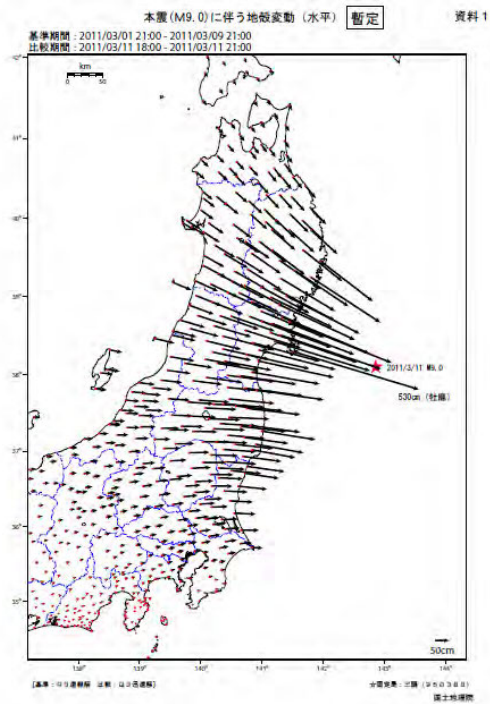

Fig. 1 Crustal deformation associated with the 2011 off the Pacific coast of Tohoku Earthquake on March 11, 2011 (horizontal)

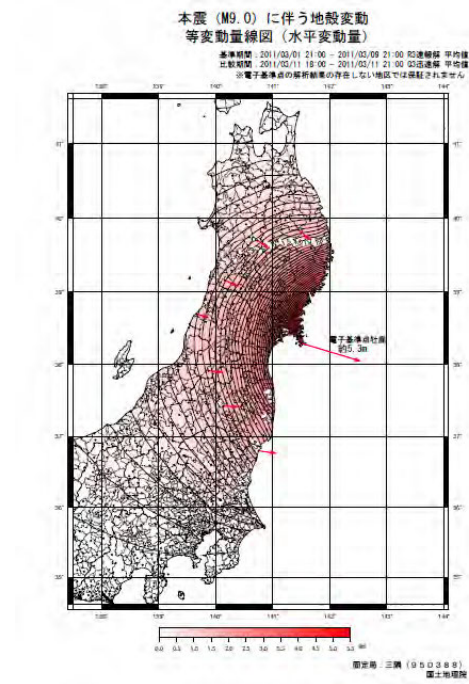

Fig. 3 Contour map of crustal deformation of the 2011 Tohoku Earthquake (horizontal).

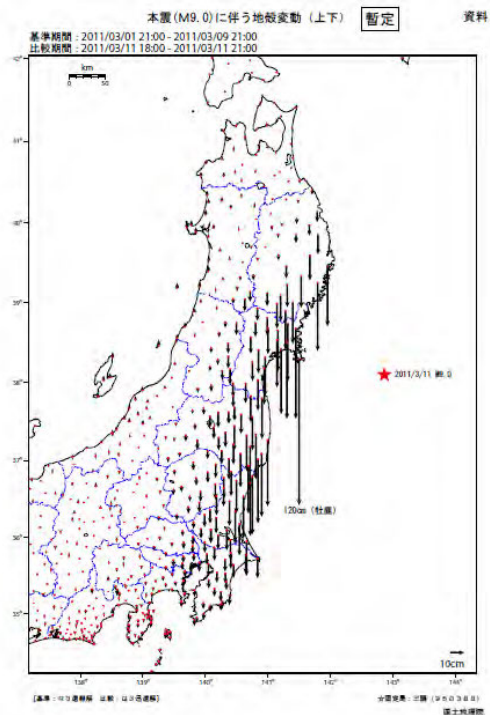

Fig. 2 Crustal deformation associated with the 2011 off the Pacific coast of Tohoku Earthquake on March 11, 2011 (vertical).

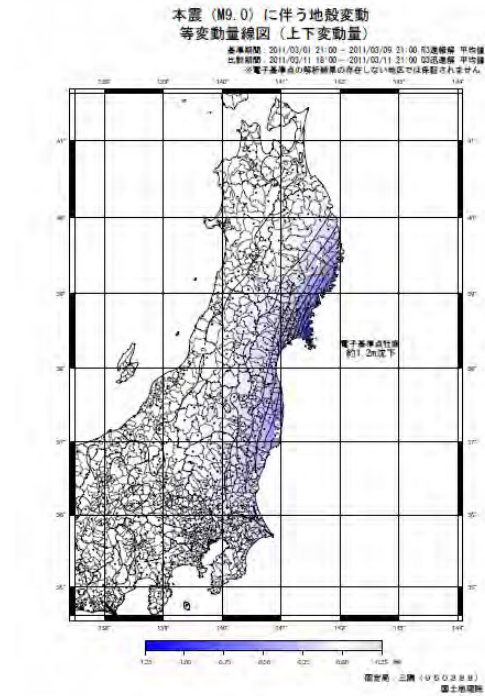
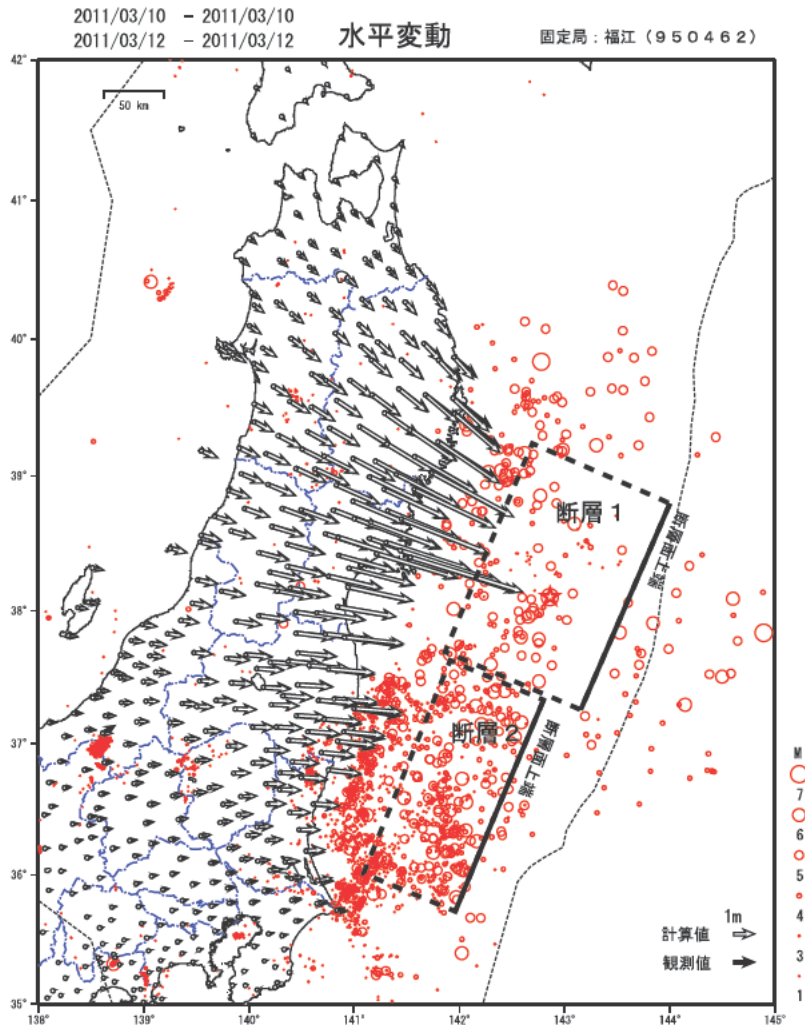

Fig. 4 Contour map of crustal deformation of the 2011 Tohoku Earthquake (vertical).

東北地方太平洋沖地震（2011年3月11日）の震源断層モデル

北側の矩形断層で2.5mの大きなすべり、南側の断層で6m程のすべりが推定された。
断層1の領域では、余震があまり発生していない。



星印は気象庁の震央（142.861°，38.104°）。

矩形断層二枚での推定結果。

西側に傾き下がる逆断層。モーメントマグニチュードは北側が8.8、南側が8.3。2つ合わせて8.9。

断層の長さは南北に約190kmの断層1と約190kmの断層2で合計約380km。

赤丸は気象庁一元化震源（3/11-3/15）。

	緯度	経度	上端深さ km	長さ km	幅 km	走向	傾斜角	すべり角	すべり量 m	Mw
断層1	38.80°	144.00°	5.1	186	129	203	16	101	24.7	8.8
断層2	37.33°	142.80°	17.0	194	88	203	15	83	6.1	8.3

Lat=38.80 Lon=144.00 D=5.1km L=186.2km W=128.5km Strike=203deg Dip=16deg Rake=101deg Slip=24.69m Open=0.0m Mw=8.8
Lat=37.33 Lon=142.80 D=17.0km L=193.9km W=87.9km Strike=203deg Dip=15deg Rake=83deg Slip=6.12m Open=0.0m Mw=8.3

Fig. 5 Earthquake source fault model of the 2011 off the Pacific coast of Tohoku Earthquake (rectangular fault model).

Northern segment: L=186km, W=129km, strike=203deg, dip=16deg, rake=101deg, slip=24.7m, Mw=8.8

Southern segment: L=194km, W=88km, strike=203deg, dip=15deg, rake=63deg, slip=6.1m, Mw=8.3

平成 23 年 (2011 年) 東北地方太平洋沖地震
プレート境界面上の地震時のすべり分布モデル

データ期間 20110310 - 20110312 (F3 解) 固定局 : 福江 (950462)

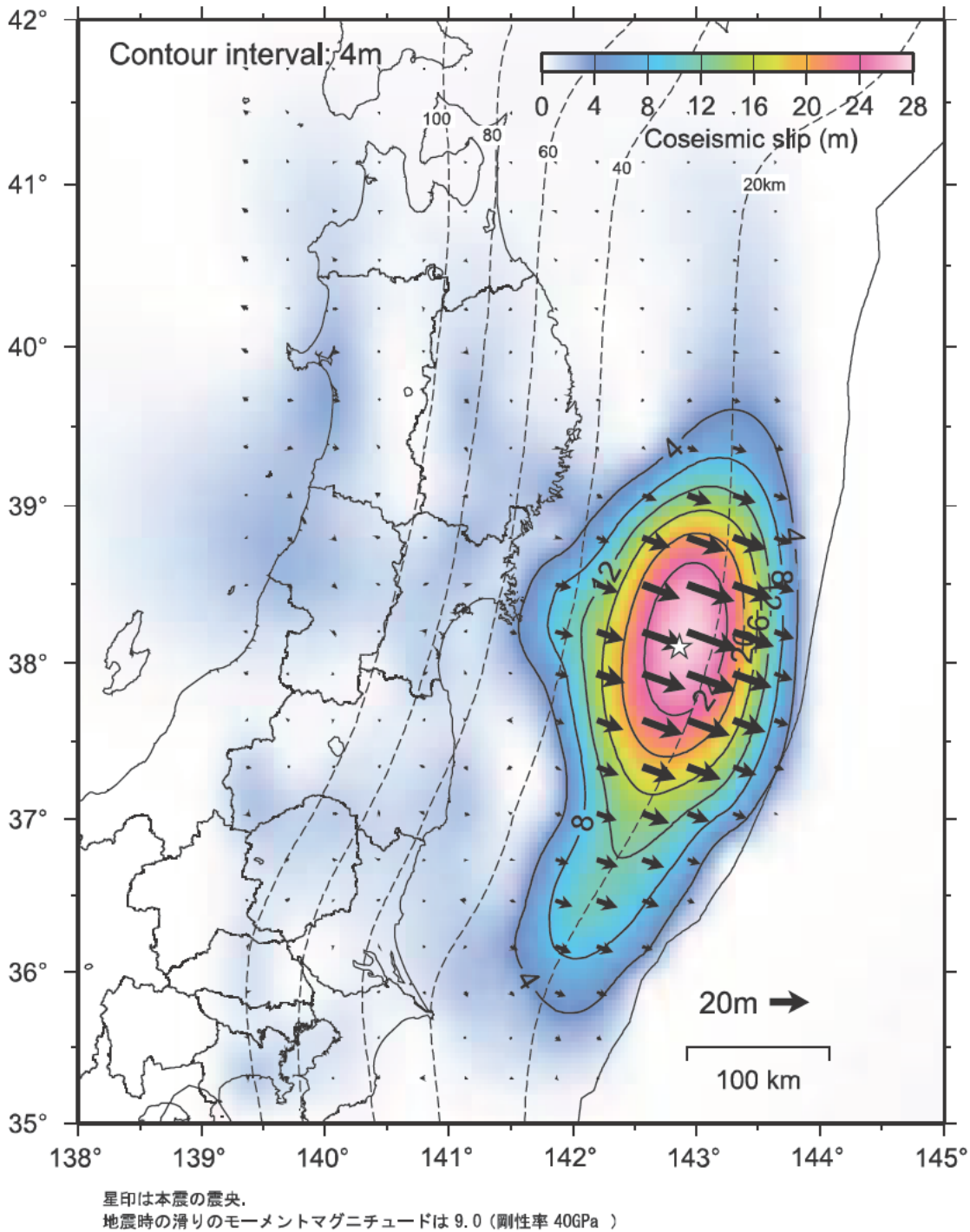
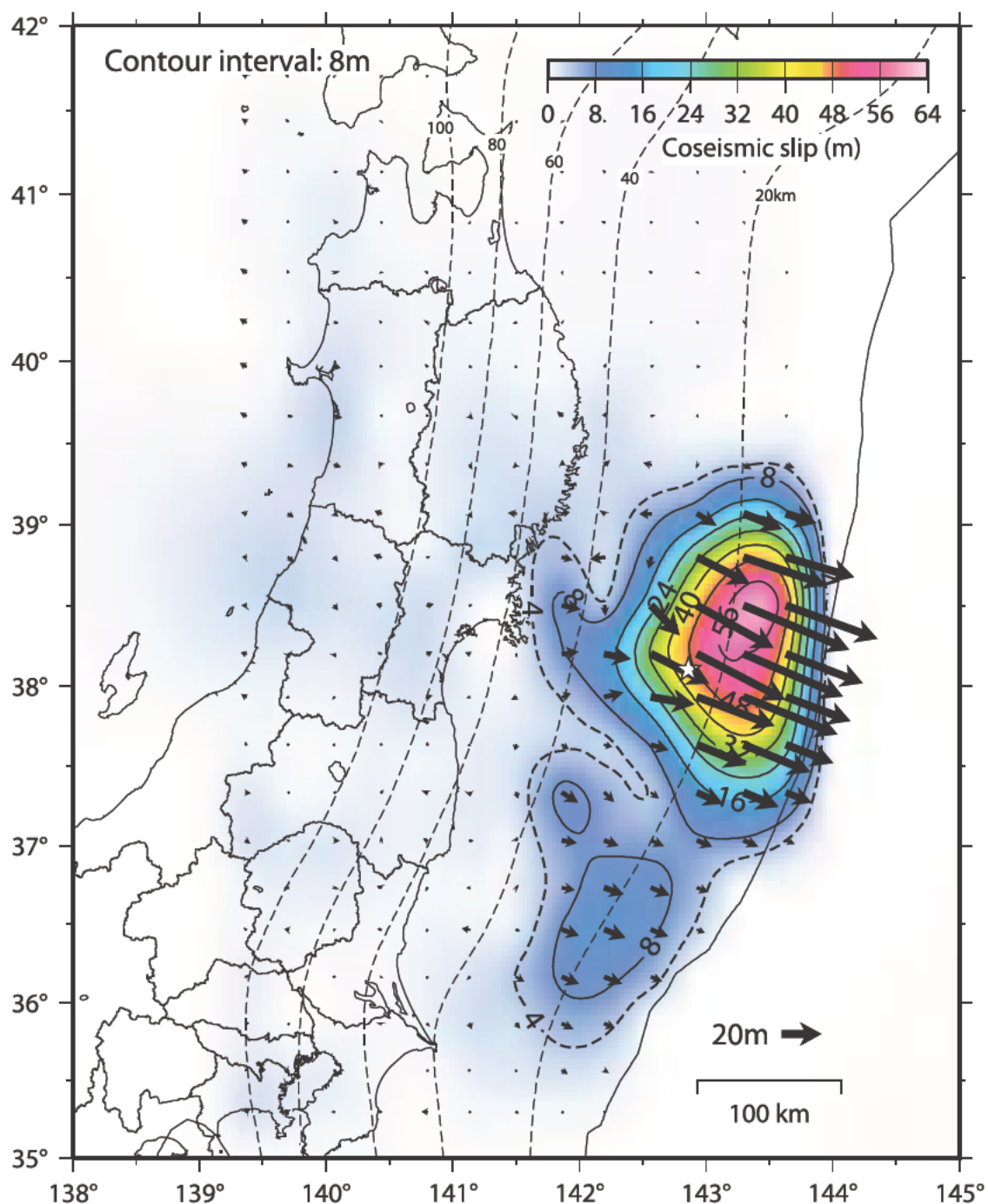

Fig. 6 Slip distribution model of the 2011 off the Pacific coast of Tohoku Earthquake, based on GEONET observation (slip distribution model on the plate interface)

データ期間 20110310-20110312 (F3解) 固定局: 福江 (950462) + SGO by JCG5



星印は本震の震央。
 地震時の滑りのモーメントマグニチュードは 9.0 (剛性率 40GPa)
 点線はプレート境界面の深さを示す

Fig. 7 Slip distribution model of the 2011 off the Pacific coast of Tohoku Earthquake, based on GEONET observation on land and seafloor crustal deformation by GPS/acoustic observations (slip distribution model on the plate interface)

成分変化グラフ (地震後)

期間 : 2011/03/12 ~ 2011/06/30 JST

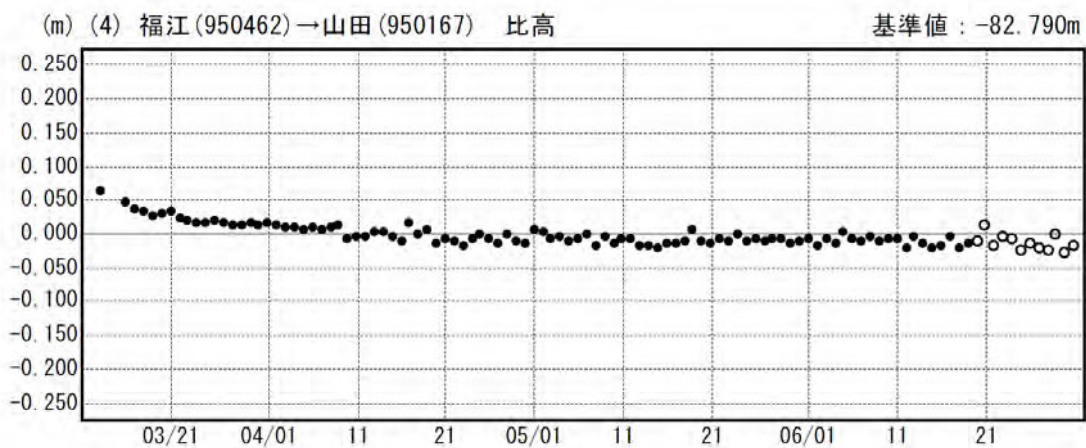
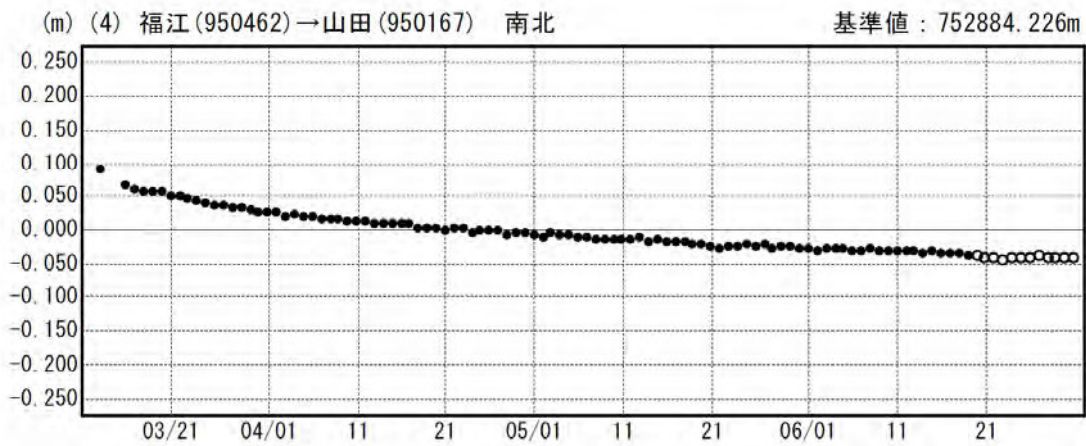
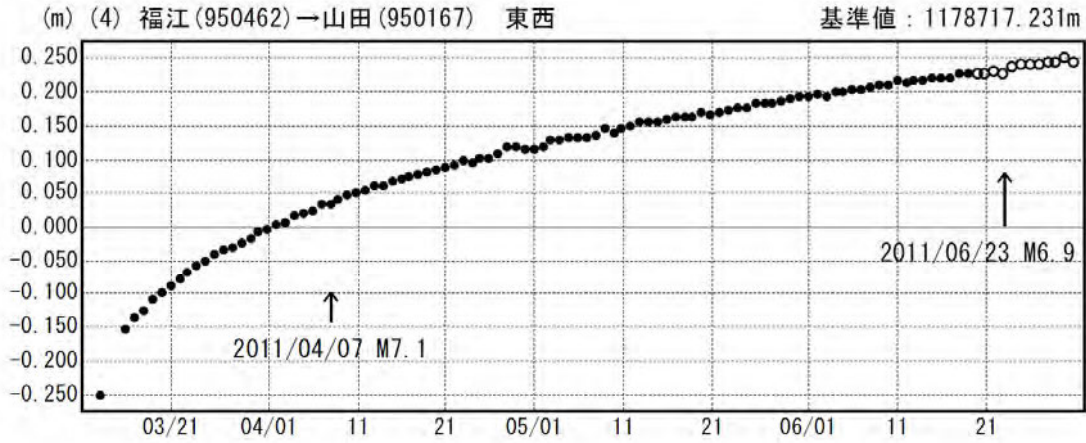

Fig. 8 Crustal deformation after the 2011 off the Pacific coast of Tohoku Earthquake, Time series at GEONET site "Yamada" in Iwate prefecture

地震後の地殻変動

データ期間 20110311 18:00 - 20110411 3:00 (日本時間) Q3 解
固定局：三隅 (950388)

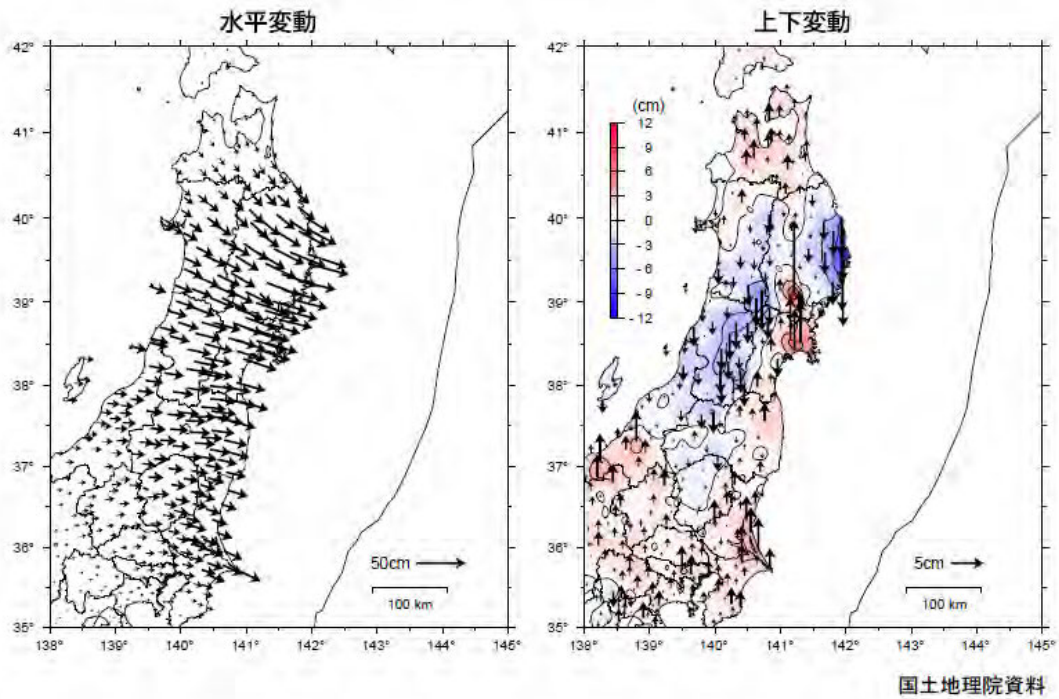

Fig. 9 (a)(left)Horizontal crustal deformation after the 2011 off the Pacific coast of Tohoku Earthquake as of April 11, 2011 (b)(right)Vertical crustal deformation after the 2011 off the Pacific coast of Tohoku Earthquake as of April 11, 2011.

データ期間 20110311 18:00 - 20110727 18:00 (日本時間)
Data from 20110311 18:00 to 20110727 18:00 JST

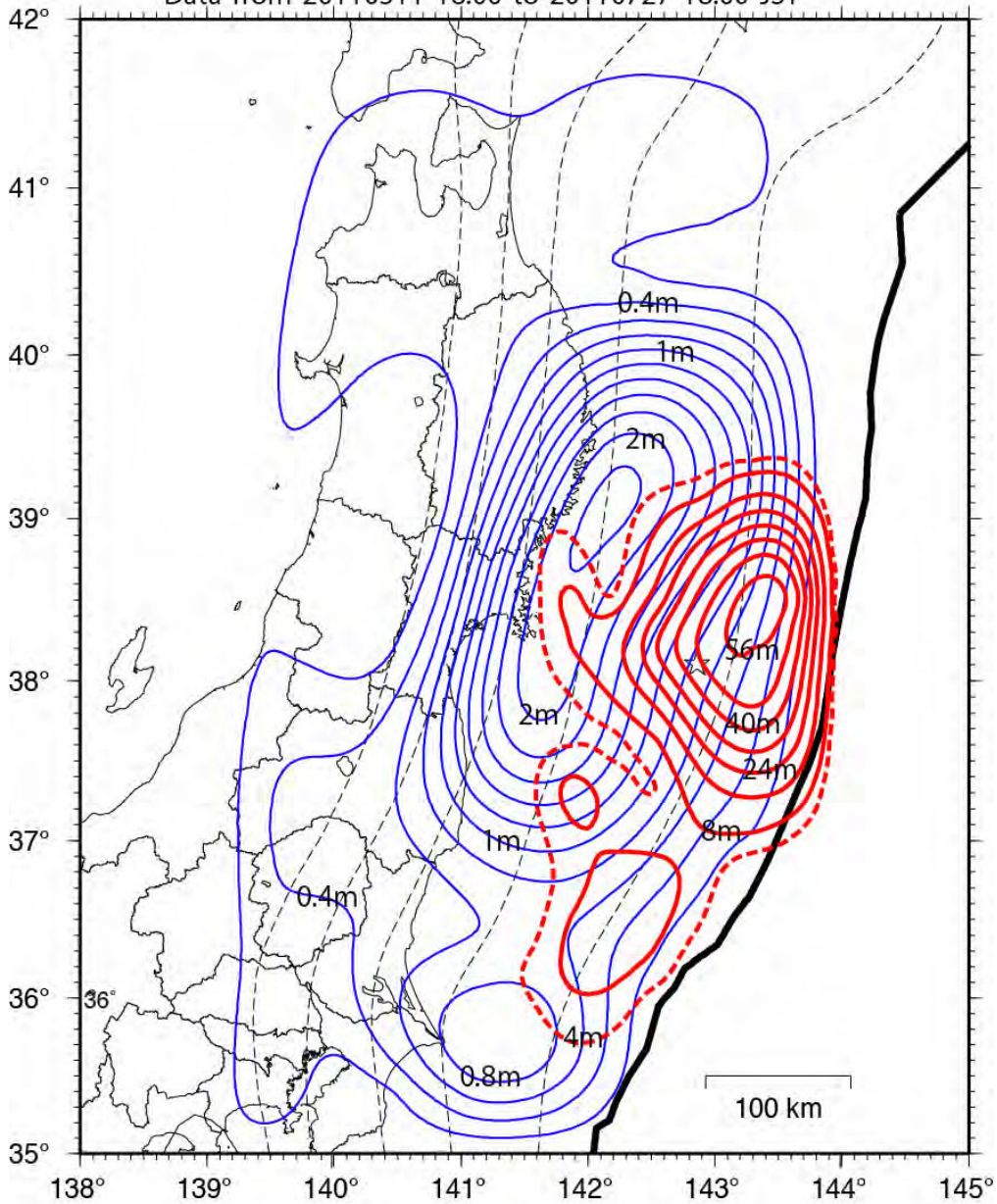

Fig. 10 Slip distribution model for postseismic crustal deformation of the 2011 off the Pacific coast of Tohoku Earthquake based on GEONET observations (blue lines), overlaying onto the coseismic slip distribution based on GEONET observation on land and seafloor crustal deformation by GPS/acoustic observations (red lines).

Building damage by the 2011 off the Pacific coast of Tohoku earthquake and coping activities by NILIM and BRI collaborated with the administration

by

Isao Nishiyama¹, Izuru Okawa², Hiroshi Fukuyama³ and Yasuo Okuda³

ABSTRACT

This paper presents the outlines of the strong motions observed mainly by the Building Research Institute (BRI) Strong Motion Network, the motion induced building damage and the tsunami induced building damage by the 2011 off the Pacific coast of Tohoku earthquake (the Great East Japan earthquake) (hereinafter referred to as the Tohoku earthquake). Coping activities in order to establish necessary technical standards by the National Institute for Land & Infrastructure Management (NILIM) and BRI collaborated with the administration are also outlined.

As for the strong motions, it presents observed motions at in and out of the buildings to show the earthquake input and the response of the buildings. It also presents observations of the super high-rise buildings and the seismically isolated buildings under long-period earthquake ground motions. Ministry of Land, Infrastructure Transport and Tourism (MLIT) and NILIM with the assistance of BRI released the Tentative New Proposal [1.1] for countermeasure against long-period earthquake ground motion on super high-rise buildings and seismically isolated buildings, whose general outline is also introduced.

As for the motion induced building damage, it presents the general outline of the field survey on wood houses, structural steel buildings, reinforced concrete buildings, seismically isolated buildings and so on with the classified typical damage patterns for each structural systems based on the Quick Report [1.2], which does not give complete survey because of the widely damaged area affected by the Tohoku earthquake.

As for the tsunami induced damage of buildings, the general outline of damage of wood houses,

structural steel buildings and reinforced concrete buildings is presented with typical damage patterns observed also from the Quick Report. The database on the damaged buildings subject to tsunami which is compiled in the Quick Report is utilized to verify the tsunami load defined in the Guidelines [1.3] for tsunami evacuation building made by the Cabinet Office.

In consideration of the building damage and so on by the Tohoku earthquake, “tsunami”, “non-structural elements”, “long-period earthquake ground motion” and “liquefaction” are important technical issues to be countermeasured by the administration. On these issues, the general outline of the coping activities by NILIM and BRI collaborated with the administration utilizing the Grant-in-aid [1.4] for maintenance and promotion of building codes / standards is introduced.

KEYWORDS: Building Damage, Falling Down of Ceilings, Liquefaction, Long-Period Ground Motion, Tsunami, 2011 off the Pacific Coast of Tohoku Earthquake

¹ Director, Building Department, National Institute for Land & Infrastructure Management (NILIM), Ministry of Land, Infrastructure, Transport & Tourism (MLIT), Tsukuba-shi, Ibaraki-ken 305-0802, Japan.

² Senior Research Fellow, Department of Structural Engineering, Building Research Institute (BRI), ditto.

³ Chief Research Engineer, Department of Structural Engineering, BRI, ditto.

1. INTRODUCTION

The Tohoku earthquake of moment magnitude (Mw) 9.0 occurred at 14:46 JST on March 11, 2011 and generated gigantic tsunami in the Tohoku and Kanto Areas of the northeastern part of Japan. This was a thrust earthquake occurring at the boundary between the North American and Pacific plates. This earthquake is the greatest in Japanese recorded history and the fourth largest in the world since 1900 according to U.S. Geological Survey [1.5]. An earthquake of Mw 7.5 foreshock preceded the main shock on March 9 and many large aftershocks followed including three Mw 7-class aftershocks on the same day of the main shock.

As the epicentral distribution of the aftershocks of the Tohoku earthquake (hypocentral region) is widely located off the coast of the prefectures of Iwate, Miyagi, Fukushima and Ibaraki with approximately 450km in length in North-South direction and 150km in width in East-West direction. The distance from these prefectures to the fault plane is almost the same, thus the places with the seismic intensity of about 6 (6+ or 6-) according to the Japan Meteorological Agency (JMA) widely spread in these prefectures. The maximum JMA seismic intensity of 7 was recorded by the strong motion recording network (K-NET) [1.6] of the National Research Institute for Earth Science and Disaster Prevention (NIED) at Kurihara City (K-NET Tsukidate) shown by the purple color in Fig. 1.1, Miyagi Prefecture, where the instrumental seismic intensity was 6.6.

Field survey by NILIM and BRI was started from Kurihara City and was followed by the locations shown in Fig. 1.2. In this paper, the results of the field survey at these locations are reported. In the coastal area from Aomori Prefecture to Miyagi Prefecture, the tsunami induced building damage was mainly surveyed. The area facing to the Pacific Ocean in Fukushima Prefecture was excluded from the survey in the cause of the accident in Fukushima Daiichi Nuclear Power Station. At the catchment basin area of Tone River in the border between

Ibaraki and Chiba Prefectures and Urayasu City on the Tokyo Bay, damage of residential land associated with liquefaction was surveyed.

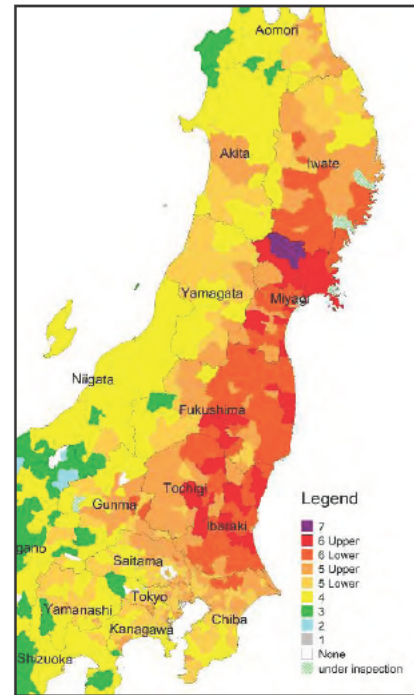

Fig. 1.1 JMA Seismic Intensity Map

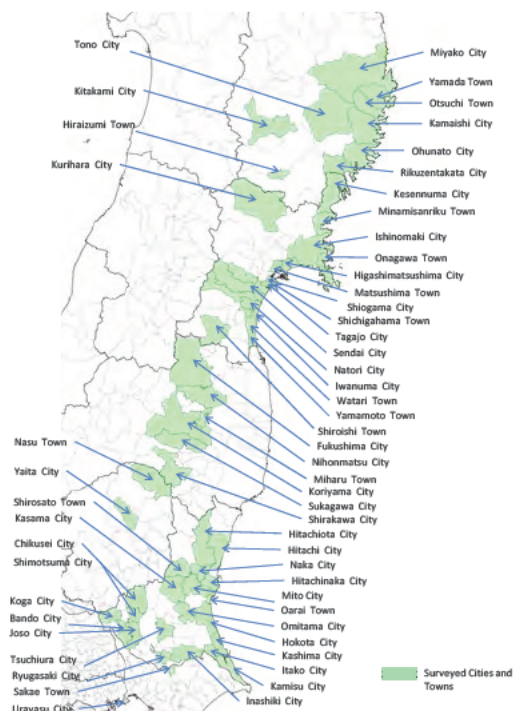

Fig. 1.2 Locations of Surveyed Cities and Towns

These surveys were made from the viewpoint of finding whether there is something to reflect to current building structural codes or not. Namely, are there new damage pattern in the motion induced building damage? In case for tsunami induced building damage, the technical information on the collapsed, overturned, washed away buildings are collected to verify the load effect by tsunami. As will be explained in the following chapters, the motion induced building damage is generally small and especially those buildings which satisfy current seismic code after 1981 performed quite well with almost no severe

damage such as collapse reported.

Strong motions are recorded in good quality during many large scale aftershocks in addition to main shock and foreshock at in and out of the buildings by the BRI Strong Motion Network and so on. Especially, they are valuable to see the characteristic of long-period earthquake ground motion, which is thought to be strongly generated and amplified in the occasion of huge earthquake, and to see the corresponding building responses.

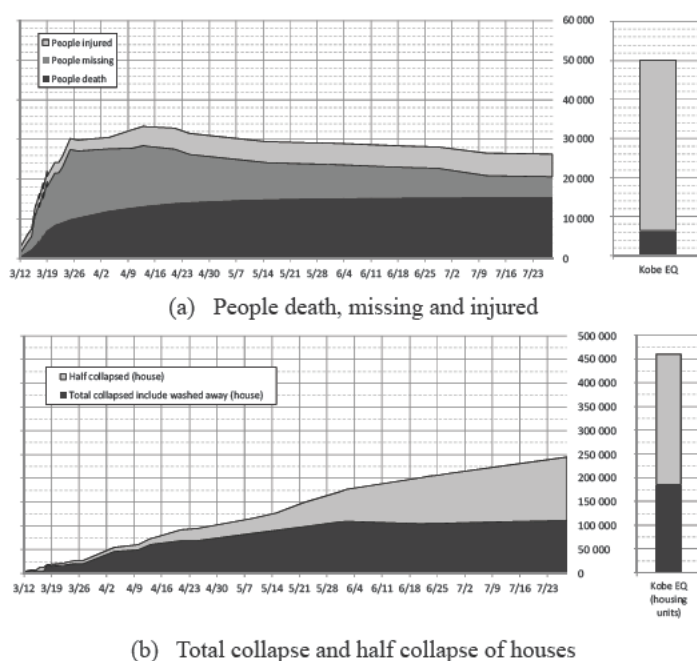

Fig. 1.3 Progress of People Death (top) and Building Collapse (bottom) by the Tohoku Earthquake compared with those by Kobe Earthquake

The statistical data on the people death and the building collapse are announced from the National Policy Agency [1.7] (August 15, 2011). Fig. 1.3(a) shows the progress of people death which is compared to that in the 1995 Hyogoken Nambu earthquake (Kobe earthquake), which shows that the number of people death in the Tohoku earthquake is almost 2.5 times as that in the Kobe earthquake. Fig. 1.3(b) shows the progress of building collapse which is again compared to that in Kobe earthquake. The unit of the statistical data is different, “house” for the

Tohoku earthquake and “housing units=household” for the Kobe earthquake, but it can be said that “total collapse” and “half collapse” are both almost half in the Tohoku earthquake. The Tohoku earthquake is much larger than the Kobe earthquake and the affected area is far larger as a result, and also the washed away houses are included in the total collapsed buildings. Thus, the motion induced building damage is far below in damage ratio than that in the Kobe earthquake. The Press Release [1.8] by the Urban Bureau of MLIT showed that the total

collapsed houses in the tsunami inundation area reached about 120,000, which is almost the same number of total collapse by the National Policy Agency. This fact agrees well with the result by the field survey.

As the lessons from the Tohoku earthquake, the following administrative issues are listed up: load effect on building by tsunami, countermeasure for falling down of non-

structural elements such as ceiling, countermeasure for long-period earthquake ground motion on super high-rise buildings etc., and countermeasure for liquefaction of residential land. NILIM and BRI are cooperatively working on coping activities collaborated with the administration, which is also introduced in this paper.

2. EARTHQUAKE AND GROUND MOTIONS

2.1 Earthquake Mechanism

The Tohoku earthquake occurred with wide seismic source extending from off Sanriku to the coast of Ibaraki Prefecture as shown in Fig. 2.1 [2.1]. The figure also shows the slip distribution on the fault plane estimated using the strong motion records from the near recording stations shown with green triangles. The green star shows the epicenter, the rupture initiation location for the main shock.

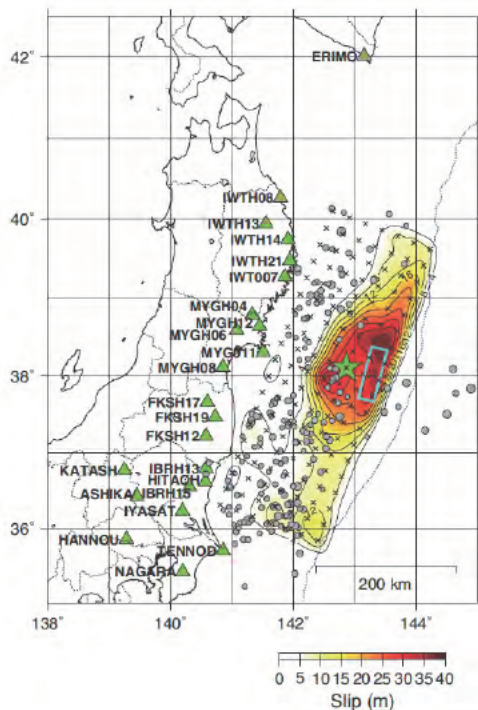

Fig.2.1 Slip Distribution on Earthquake Source analyzed using Near Site Strong Motion Records (Yoshida et al., 2011 [2.1])

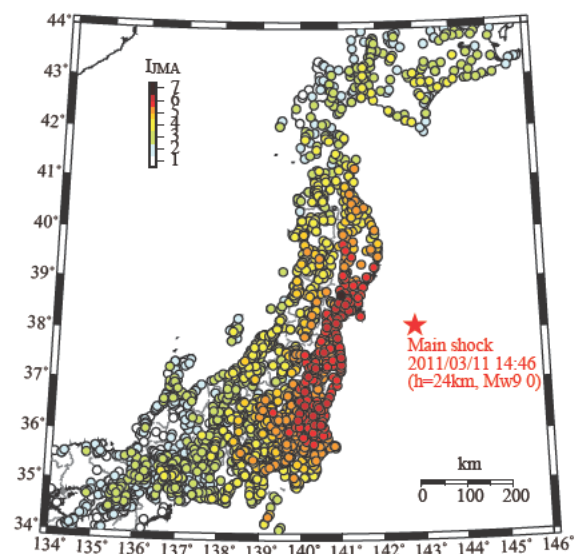

Fig.2.2 JMA Seismic Intensity Distribution for the Main Shock

It was also clarified that the Tohoku earthquake occurred on the subduction zone between the Pacific and the North American plates and was of thrust type. The Tohoku earthquake generated large tsunami and the devastation caused the unprecedented enormous loss of lives and substantial damage to the broader society in the eastern Japan.

The magnitude of the event was determined Mw 9.0 by JMA, the largest in the earthquake instrumentation history of Japan.

2.2 Distribution of Seismic Intensities

Fig. 2.2 shows the distribution of JMA seismic intensities observed during the main shock. An

asterisk(★) represents the location of the epicenter. The seismic intensity 7 was observed in Kurihara City, Miyagi Prefecture, and JMA seismic intensity 6+ was observed in wide area of Miyagi, Fukushima, Ibaraki, and Tochigi Prefectures. The area with JMA seismic intensity 6- extends to Iwate, Gunma, Saitama, and Chiba Prefectures.

2.3 Characteristics of Earthquake Motions

During the Tohoku earthquake, severe ground motions were observed in wide area, and massive amounts of strong motion records were accumulated. This section describes the characteristics of strong motion records at recording stations that suffered high seismic intensities, based on K-NET of NIED [1.6]. Fig. 2.3 shows acceleration waveforms and pseudo velocity response spectra with the damping ratio of 5% of strong motion records at K-NET

Tsukidate station that recorded JMA seismic intensity 7, and K-NET Sendai and K-NET Hitachi stations among seismic intensity 6+ stations.

Among strong motion recording stations, only K-NET Tsukidate, which is located in Kurihara City, Miyagi Prefecture, recorded the seismic intensity 7 during the main shock of the Tohoku earthquake. From the acceleration records in the upper-row in Fig. 2.3, a maximum acceleration in the N-S direction is understood to have reached almost 3700 cm/s^2 , representing that the main shock caused excessively severe earthquake motions. As seen from the pseudo velocity responses on the right diagram, a response in the N-S direction with a period of about 0.2 seconds becomes particularly large. This indicates earthquake ground motions that are dominated by short periods.

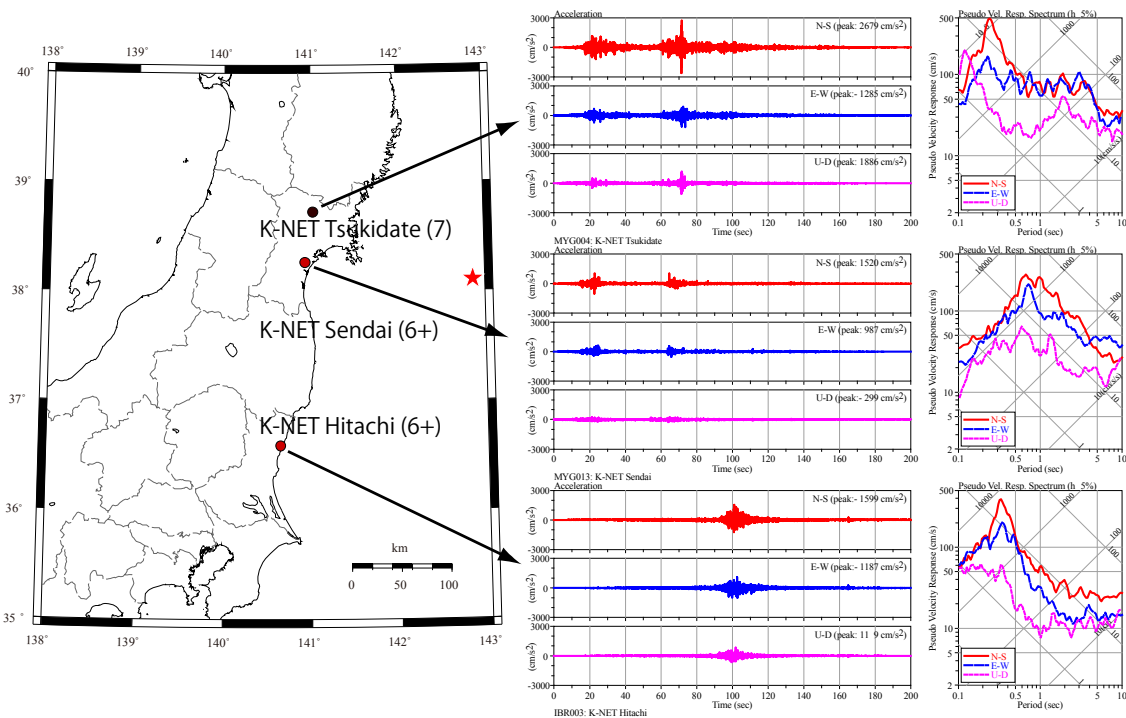

Fig.2.3 Acceleration Waveforms and Pseudo Velocity Response Spectra recorded at K-NET Stations

K-NET Sendai, which is located about 4 km east from the Sendai Station, recorded Intensity 6+ during the main shock. A maximum acceleration

in strong motion records (mid-row in Fig. 2.3) obtained from the network exceeds 1500 cm/s^2 in the N-S direction, indicating a higher level of the

main shock. In contrast to K-NET Tsukidate, earthquake motions that were recorded in K-NET Sendai are dominated by a period range of 0.5 to about 1 second, and a maximum response velocity exceeds 200 cm/s. This result is considered to reflect ground conditions in the area of K-NET Sendai that is covered with a thick alluvium.

The lower-row in Fig. 2.3 shows strong motion records that were obtained from K-NET Hitachi in Hitachi City, Ibaraki Prefecture. A seismic intensity of the main shock that was measured in this network represented seismic intensity 6+. A maximum acceleration in the N-S direction reached a higher level, or about 1600 cm/s^2 , while the pseudo velocity response spectra had a peak at about 0.3 seconds. On the other hand, the response was sharply reduced at a period longer than 0.5 seconds. This indicates that the earthquake motions were dominated in short period range. Both records of K-NET Tsukidate and K-NET Sendai show two wave groups at

about 20 seconds and 70 seconds on the time axis, but the strong motion record obtained at much southern station such as K-NET Hitachi, Ibaraki Prefecture in Kanto Area shows one large wave group. This phenomenon may have occurred associated with the focal rupture process and the wave propagation to recording stations.

2.4 Results of BRI Strong Motion Network

The BRI conducts strong motion observation that covers buildings in major cities across Japan [2.2]. When the Tohoku earthquake occurred, 58 strong motion instruments placed in Hokkaido to Kansai Areas started up. Peak accelerations of the strong motion records are listed in Table 2.1. Locations of the strong motion stations are plotted in Fig. 2.4 and Fig. 2.5. Among them, about 30 buildings suffered a shaking with seismic intensity 5- or more. This section presents some characteristic strong motion records.

Table 2.1 Strong motion records obtained by BRI strong motion network (1/4)

Code	Station name	Δ (km)	I_{JMA}	Azi- muth	Loc.	Max. Acc. (cm/s ²)		
						H1	H2	V
SND	Sendai Government Office Bldg. #2	175	5.2	074°	B2F*	163	259	147
					15F	361	346	543
THU	Tohoku University	177	5.6	192°	01F*	333	330	257
					09F	908	728	640
MYK	Miyako City Hall	188	4.8	167°	01F	138	122	277
					07F	246	197	359
					GL*	174	174	240
IWK	Iwaki City Hall	210	5.3	180°	B1F*	175	176	147
					09F	579	449	260
TRO	Tsuruoka Government Office Bldg.	275	3.9	182°	01F*	34	36	14
					04F	37	39	15
HCN2	Annex, Hachinohe City Hall	292	5.2	164°	GL*	286	210	61
					G30	86	89	49
					G105	36	46	32
					10F	120	123	206
					01F	91	122	73
					B1F	100	104	58
HCN	Main bldg., Hachinohe City Hall	292	4.6	164°	B1F*	97	110	55
					06F	348	335	78
AKT	Akita Prefectural Office	299	4.3	087°	08F	175	192	44
					B1F*	50	47	24
ANX	Building Research Institute	330	5.3	180°	A01*	279	227	248
					A89	142	153	102
					BFE	194	191	136
					8FE	597	506	344
					MBC	203	206	152
					M8C	682	585	311
BRI	Training Lab., BRI	330	5.4	180°	01F*	281	273	165
TKC	Tsukuba City Hall (Base-isolation)	334	5.2	004°	B1F*	327	233	122
					01F	92	76	198
					06F	126	91	243
NIG	Niigata City Hall	335	3.9	061°	B1F*	28	40	14
					07F	39	55	14
HRH	Hirosaki Legal Affairs Office	346	3.4	195°	01F*	28	25	15
TUS	Noda Campus, Tokyo Univ. Of Science	357	5.1	000°	01F*	269	263	151
YCY	Yachiyo City Hall	361	5.3	302°	B1F	140	135	92
					GL*	312	306	171
					07F	486	359	145
NIT	Nippon Institute of Technology	362	5.1	288°	GL*	230	197	79
					01F	150	119	63
					06F	283	322	131
MST	Misato City Hall	367	4.9	258°	01F	72	104	71
					GL*	130	127	73
					07F	219	190	106

Note) Δ : epicentral distance, I_{JMA} : JMA instrumental seismic intensity (using an asterisked sensor), Azimuth: clockwise direction from North, H1, H2, V: maximum accelerations in horizontal #1 (Azimuth), horizontal #2 (Azimuth+90°) and vertical directions

Table 2.1 Strong motion records obtained by BRI strong motion network (2/4)

Code	Station name	Δ (km)	I_{JMA}	Azi- muth	Loc.	Max. Acc. (cm/s ²)		
						H1	H2	V
FNB	Educational Center, Funabashi City	368	4.7	357°	01F	144	147	63
					GL*	133	145	105
					08F	359	339	141
CHB	Chiba Government Office Bldg. #2	369	4.9	346°	B1F	152	122	51
					08F	375	283	117
					GL*	168	175	100
ICK	Gyotoku Library, Ichikawa City	375	5.2	321°	01F*	164	163	71
					02F	178	186	80
					05F	240	300	104
EDG	Edogawa Ward Office	377	4.8	003°	01F*	112	112	69
					05F	256	299	77
ADC	Adachi Government Office Bldg.	377	4.8	012°	01F*	118	103	71
					04F	266	146	95
SIT2	Saitama Shintoshin Government Office Building #2	378	4.4	340°	B3F*	74	63	42
					10FS	119	138	62
					27FS	248	503	107
SITA	Arena, Saitama Shintoshin Government Office Building	378	4.5	313°	01F*	90	105	47
TDS	Toda City Hall	380	5.0	354°	GL*	203	206	53
					B1F	140	173	65
					08F	425	531	160
AKB	Akabane Hall, Kita Ward	380	4.6	354°	B1F*	85	139	59
					06F	180	250	86
SMD	Sumida Ward Office	380	4.3	000°	20F	385	290	81
					08F	263	197	46
					B1F*	69	66	34
NMW	National Museum of Western Art (Base-isolation)	382	4.8	218°	GL*	265	194	150
					B1FW	100	79	84
					01FW	76	89	87
					04F	100	77	90
UTK	Bldg. #11, University of Tokyo	383	4.7	348°	7FN	181	212	58
					7FS	201	360	160
					01F	73	151	49
					GL*	197	218	79
TKD	Kosha Tower Tsukuda	385	4.4	180°	01F*	87	98	41
					18F	118	141	64
					37F	162	198	108
CGC	Central Government Office Bldg. #6	386	4.4	208°	01F*	90	86	45
					20B	208	148	173
					19C	179	133	130
CG2	Central Government Office Bldg. #2	386	4.2	208°	B4F*	75	71	49
					13F	137	113	72
					21F	121	131	104
CG3	Central Government Office Bldg. #3 (Base-isolation)	386	4.5	208°	B2F*	104	91	58
					B1F	55	41	62
					12F	94	82	104

Note) Δ : epicentral distance, I_{JMA} : JMA instrumental seismic intensity (using an asterisked sensor), Azimuth: clockwise direction from North, H1, H2, V: maximum accelerations in horizontal #1 (Azimuth), horizontal #2 (Azimuth+90°) and vertical directions

Table 2.1 Strong motion records obtained by BRI strong motion network (3/4)

Code	Station name	Δ (km)	I_{JMA}	Azi- muth	Loc.	Max. Acc. (cm/s ²)		
						H1	H2	V
NDLA	Annex, National Diet Library	387	4.5	354°	B8F	61	88	53
					B4F	68	101	56
					01F*	76	104	84
					04F	125	192	94
NDLG	Ground, National Diet Library	387	5.0	354°	G35	72	71	51
					G24	95	116	54
					GL*	224	201	93
NDLM	Main Bldg., National Diet Library	387	4.5	354°	01S*	70	94	60
					17S	458	489	111
NKN	Nakano Branch, Tokyo Legal Affairs Bureau	390	4.8	359°	06F	172	375	56
					01F*	126	158	54
TUF	Tokyo University of Marine Science and Technology	390	5.0	000°	01F	174	169	60
					GL*	181	189	71
					07F	316	223	66
KDI	College of Land, Infrastructure and Transport	401	4.6	090°	03F	129	329	55
					01F	110	136	53
					GL*	167	143	50
KWS	Kawasaki-minami Office, Labour Standards Bureau	401	4.7	045°	01F*	107	77	30
					02F	133	123	49
					07F	366	304	76
NGN	Nagano Prefectural Office	444	2.7	157°	B1F*	8	7	8
					11F	35	27	9
HKD	Hakodate Development and Construction Department	447	3.5	180°	GL*	25	28	13
HRO	Hiroo Town Office	466	2.7	140°	01F*	17	20	8
YMN	Yamanashi Prefectural Office (Base-isolation)	468	3.9	006°	B1F	47	39	18
					GL*	51	44	20
					01F	37	52	20
					08F	41	51	25
SMS	Shimoda Office, Shizuoka Prefecture	517	2.9	225°	GL*	12	19	10
SMZ	Shimizu Government Office Bldg.	520	4.2	165°	01F*	28	40	15
					11F	81	56	18
KSO	Kiso Office, Nagano Prefecture	524	2.6	292°	B1F*	9	10	8
					6F	32	31	10
KGC	Kushiro Government Office Bldg. (Base-isolation)	558	2.6	167°	GL*	12	14	6
					G10	10	10	4
					G34	5	5	3
					B1F	8	12	4
					01F	10	16	6
09F	16	19	12					
HKU	Hokkaido University	567	2.7	172°	GL*	10	9	5
NGY	Nagoya Government Office Bldg. #1	623	3.1 [#]	174°	GL*	8	15	-
					B2F	9	14	7
					12F	25	46	7
MTS	Matsusaka Office, Mie Prefecture	688	2.3	216°	07F	16	8	4
					01F*	6	5	3

Note) Δ : epicentral distance, I_{JMA} : JMA instrumental seismic intensity (using an asterisked sensor), Azimuth: clockwise direction from North, H1, H2, V: maximum accelerations in horizontal #1 (Azimuth), horizontal #2 (Azimuth+90°) and vertical directions, [#]: calculated from two horizontal accelerations because of trouble on the vertical sensor

Table 2.1 Strong motion records obtained by BRI strong motion network (4/4)

Code	Station name	Δ (km)	I_{JMA}	Azi-muth	Loc.	Max. Acc. (cm/s ²)		
						H1	H2	V
MIZ	Maizuru City Hall	726	0.9	085°	01F	1	2	2
					05F*	1	1	2
OSK	Osaka Government Office Bldg. #3	759	2.9	189°	18F	65	38	7
					B3F*	11	9	5
SKS	Sakishima Office, Osaka Prefecture	770	3.0	229°	01F*	35	33	80
					18F	41	38	61
					38F	85	57	18
					52FN	127	88	13
					52FS	129	85	12

Note) Δ : epicentral distance, I_{JMA} : JMA instrumental seismic intensity (using an asterisked sensor), Azimuth: clockwise direction from North, H1, H2, V: maximum accelerations in horizontal #1 (Azimuth), horizontal #2 (Azimuth+90°) and vertical directions

2.4.1 Strong motion records of damaged buildings

Among buildings in the BRI Strong Motion Network, at least 4 buildings suffered severe earthquake motions and then some damage. One example of the damaged buildings is the building of the Human Environmental Course, Tohoku University. This is the 9-story steel reinforced concrete (SRC) school building that is located in the Aobayama Campus. This building has a long history of strong motion recordings. Among them, strong motion records on the ninth floor of the building that were obtained during the 1978 Miyagi-Ken-Oki earthquake are well known to have represented a maximum acceleration of more than 1000 cm/s².

During the Tohoku earthquake, multi-story shear walls suffered flexural failure and other damage. The appearance of the building is shown in Photo 2.1, and strong motion records obtained during the main shock in Fig. 2.6. This figure shows (a) acceleration waveforms in the transverse direction, (b) acceleration waveforms in the longitudinal direction, (c) building displacement in the transverse direction (relative displacement to first floor of the 9-story building), (d) building displacement in the longitudinal direction, and (e) fundamental natural periods of the building that were calculated every 10 seconds [2.3].

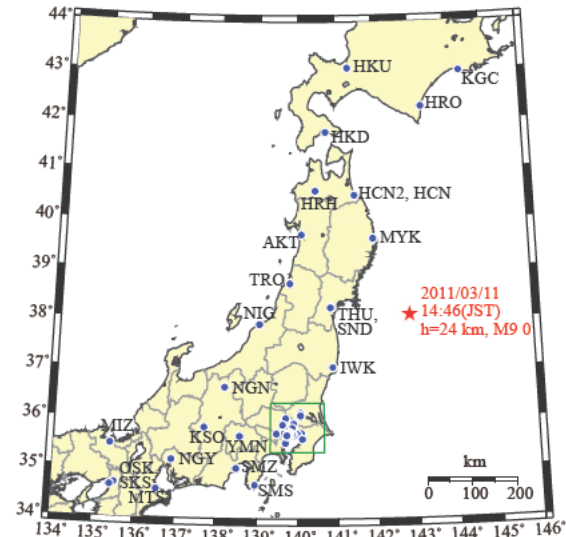

Fig.2.4 Locations of Epicenter (★) and Strong Motion Network (●)

Thick and thin lines in Fig. 2.6 (a) and (b) represent acceleration waveforms on the first and the ninth floors, respectively. Maximum accelerations on the first floor exceeded 330 cm/s² in both of the directions. A maximum acceleration on the ninth floor was 2 to 3 times larger than on the first floor, and exceeded 900 cm/s² in the transverse direction. The fundamental natural periods in Fig. 2.6 (e) represented about 0.7 seconds at the initial stage of the earthquake motion in both of the directions, but increased to about 1 second in the first wave group at the time of 40 to 50 seconds, and increased from 1.2 seconds to about 1.5 seconds

in the second wave group at the time of 80 to 100 seconds. Due to the seismic damage, the fundamental natural period finally became twice longer than that at the initial stage, and was reduced to 1/4 on a stiffness basis.

An additional comparison was made in Fig.2.7. The 1978 record at the 1st floor was compared with the 2011 record in velocity. The difference is clear that the earthquake size was different and the duration time of the 2011 Tohoku earthquake was much longer.

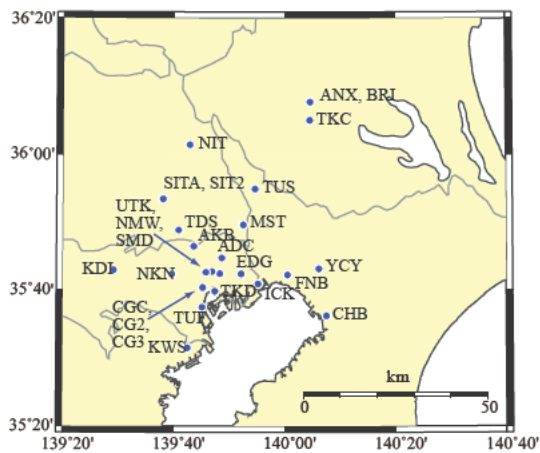

Fig. 2.5 Strong Motion Network in Kanto Area (corresponds to green rectangle in Fig. 2.4)



Photo 2.1 Appearance of the Building of the Human Environmental Course, Tohoku University

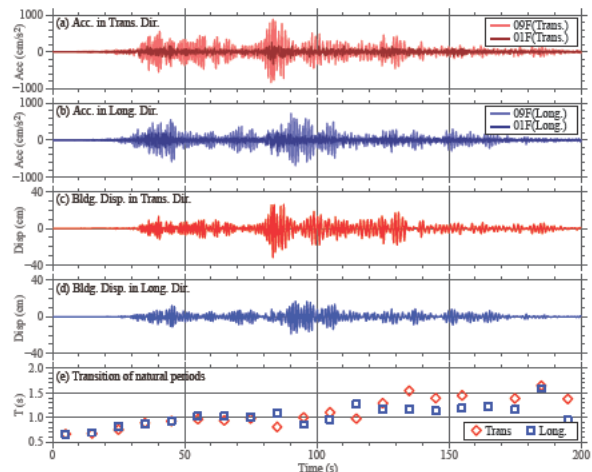

Fig. 2.6 Strong Motion Records of the Human Environmental Course, Tohoku University and Transition of Natural Periods with Time

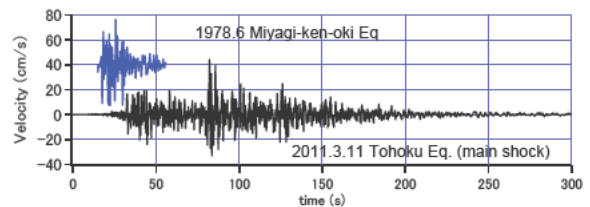

Fig.2.7 Comparison of the Recorded Motions at the 1st floor of Tohoku University Building between 1978 Miyagi-Ken-Oki and 2011 Tohoku earthquakes

2.4.2 Long-period earthquake motions in Tokyo and Osaka Bays

Long-period earthquake motions and responses of super high-rise buildings that are shaken under the motions have been socially concerned in recent years. When the Tohoku earthquake occurred, long-period earthquake motions were observed in Tokyo, Osaka and other large cities that are away from its hypocenter. This section presents two cases in Tokyo and Osaka from the BRI strong motion network.

First, a 37-story reinforced concrete (RC) super high-rise building (TKD in Table 2.1) on the coast of Tokyo Bay is introduced. Fig. 2.8 shows time histories of displacement (in two horizontal directions of S-N and W-E) that were calculated from the integration of acceleration records on the 1st and 37th floors in this building, and building displacements that were calculated by

subtracting the displacements on the 1st floor from those on the 37th in the two horizontal directions. A maximum value of ground motion displacement was about 20 cm. It is understood that the ground in itself was greatly shaken. A displacement of the building in itself that was caused by its deformation reached 15 to 17 cm.

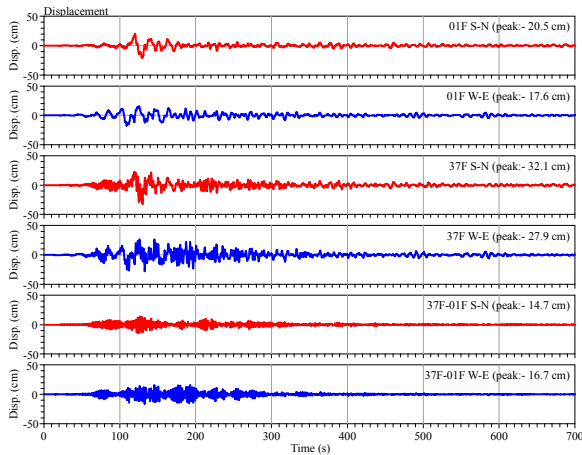

Fig. 2.8 Displacement Waveforms observed at a 37-story Residential Building in Tokyo Bay Area

Fig. 2.9 shows strong motion records that were obtained from the 55-story steel office building on the coast of Osaka Bay that is 770 km away from the hypocenter. This figure shows absolute displacements in the SW-NE and in the NW-SE directions on the 1st floor, absolute displacements in both of the directions on the 52nd floor, and building displacements (relative displacements of 52th floor to 1st floor) in both of the directions, from the top to the bottom. A ground motion displacement was not large, or less than 10 cm, but the 52nd floor in the building suffered a large motion with a zero-to-peak amplitude of more than 130 cm.

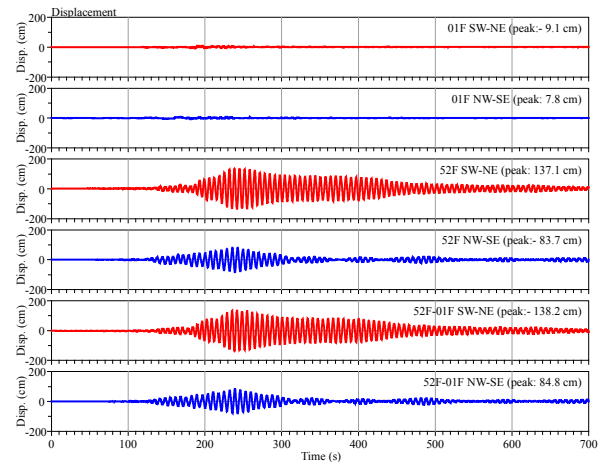

Fig. 2.9 Displacement Waveforms observed at a 55-story Office Building in Osaka Bay Area

In order to examine the properties of earthquake motions on both of the coasts of Tokyo Bay and Osaka Bay, pseudo velocity response spectra with a damping ratio of 5% of strong motion records that were obtained from the 1st floors in the buildings at the two locations are shown in Fig. 2.10. The response spectrum (left) in the records on the coast of Tokyo Bay had a peak at a period of 1 to 1.2 seconds, at 3 seconds and at 7 seconds, but a relatively flat shape in general.

On the other hand, the response spectrum (right) in the records on the coast of Osaka Bay had a large peak at 7 seconds, and amplitude of the response was not much different from on the coast of Osaka Bay. The coincidence of the fundamental natural period (6.5 to 7 seconds) in the steel office building with a predominant period of the earthquake motion is considered to have caused a resonance phenomenon and then large earthquake responses were observed at the top.

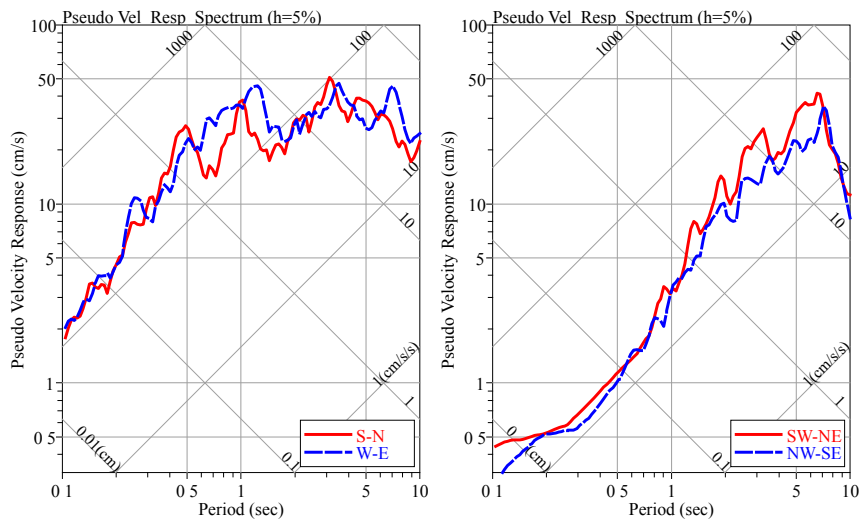

Fig. 2.10 Pseudo Velocity Response Spectra with Damping Ratio of 5% of Records in Tokyo Bay Area (left) and Osaka Bay Area (right)

3. DAMAGE OF BUILDINGS DUE TO EARTHQUAKE MOTIONS

3.1 Policy for Earthquake Damage Investigation for Buildings

The Tohoku Earthquake brought about building damage in a wide area of various prefectures on the Pacific coast in eastern Japan such as Iwate, Miyagi, Fukushima, Ibaraki and Chiba.

An epicentral region of this earthquake has a length of about 450 km and a width of about 150 km, almost in parallel with the Pacific coast in eastern Japan. A distance from the fault plane to the above prefectures is almost same. Observed earthquake motions in Sendai City close to the epicenter are not much different from those in a city far away from Sendai, for instance, Tsukuba City.

Based on these circumstances, we decided to widely survey damaged wood houses as a primary damage investigation in the northern part of Miyagi Prefecture (Kurihara City) where JMA Seismic Intensity 7 was observed, and in a wide area of Miyagi to Ibaraki Prefectures

including inland Tochigi Prefecture that suffered larger damage than coastal prefectures. In addition, as a secondary investigation, we planned to select affected areas from those subject to the primary investigation to conduct a more detailed survey on houses collecting house plans and layout of wood-shear-walls.

In order to conduct a damage investigation of steel buildings, it was decided that mainly a primary appearance investigation would be done in Sendai City with a large stock of steel buildings, and in Fukushima and Ibaraki Prefectures. As mentioned later, significant damage of structural elements was visually limited, while there were so many types of damage of nonstructural elements such as falling of exterior cladding. Consequently, focusing not on private buildings that are difficult to investigate but on school gymnasiums in Ibaraki Prefecture where many damage cases were reported that enable interior investigations, we decided to continue the primary investigation. For reference, the school gymnasiums can be seen to be similar to factories and warehouses. If the structural damage in interior building is clarified in future, more detailed investigation as

a secondary investigation on buildings other than the gymnasiums will be considered.

For a damage investigation for reinforced concrete buildings, in addition to an investigation of reportedly collapsed buildings, a primary investigation will be conducted on city halls and other public buildings that located in a wide area of the north to the south as done in the damage investigation for wood houses, and damage patterns whether they are similar or different from previously grasped patterns are examined. If there are characteristic damage patterns that should be incorporated into technical standards, the secondary investigation will be considered.

A primary investigation for damage of building lands and foundations will be conducted in Itako City, Ibaraki Prefecture, and in Urayasu City, Chiba Prefecture and its peripheral areas that was subject to severe liquefaction in the region of Kanto Area. The areas that had been affected by the 1978 Miyagi-Ken-Oki earthquake were damaged again. In these areas, also a primary damage investigation that focuses on developed housing lands will be conducted in some areas of Miyagi, Fukushima and Tochigi Prefectures.

In order to survey the damage of nonstructural elements, a primary investigation will be performed, altogether with a damage investigation for steel and reinforced concrete buildings including a requested investigation of ceiling falls in the Ibaraki Airport Building as an administrative support.

3.2 Damage of Wood Houses

3.2.1 Introduction

The survey area and the reasons of the choice are as follows;

- Kurihara City in Miyagi Prefecture: The seismic intensity 7 was recorded.
- Osaki City in Miyagi Prefecture: As a result of damage survey by others [3.1], heavy damage was reported,
- Sukagawa City in Fukushima Prefecture: RC buildings were heavily damaged.
- Nasu Town and Yaita City in Tochigi Prefecture,

and Hitachiota City and Naka City in Ibaraki Prefecture: As a result of damage survey by others [3.2], damage information has never been reported, at the time of our survey.

- Ishinomaki City in Miyagi Prefecture: Although it was almost included in the belt of seismic center, the area of the city was not flooded by the tsunami.
- Joso City and Ryugasaki City in Ibaraki Prefecture: We had damage information in the neighborhood of NILIM and BRI.

The positions of the surveyed cities and towns are shown in Fig. 3.1.

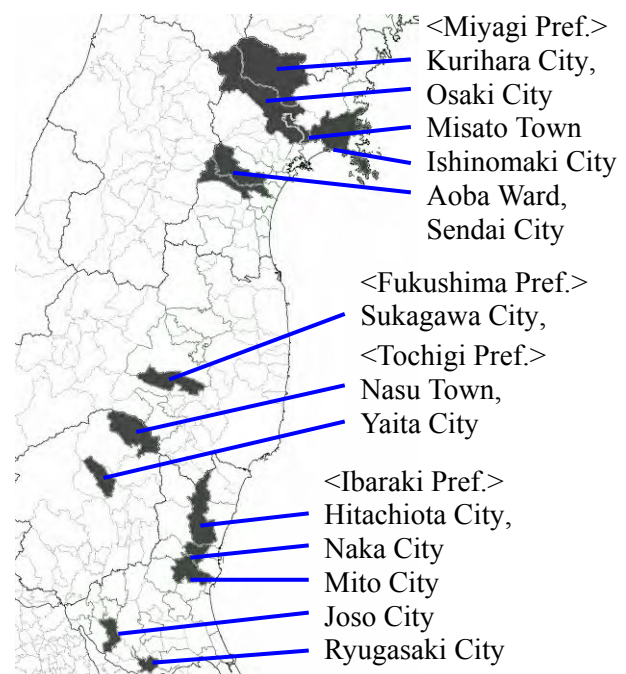

Fig. 3.1 Positions of Surveyed Cities and Towns

3.2.2 Results of the survey

(1) Kurihara City, Miyagi Prefecture

K-NET Tsukidate (MYG004 : Instrumental seismic intensity 6.6) is set up on the hillock about 3m higher than southern parking lot of Kurihara lyceum. There was a possibility of the amplification of earthquake motions. In Wakayanagi, the ground was bad and Sand eruption by liquefaction was observed. Damage of houses caused by ground transformation (Photo 3.1) and houses with store were also observed (Photo 3.2).

Great residual deformation was observed in the longitudinal direction in the large-scale wood building used to be a movie theater then renovated to a factory (Photo 3.3)



Photo 3.1 Damage of Houses caused by Ground Transformation



Photo 3.2 Damage of Houses with Store



Photo 3.3 Large-scale Wood Building renovated to a Factory

(2) Osaki City, Miyagi Prefecture

Every warehouse with the mud walls renovated as store or gallery (Photo 3.4) were damaged heavily or slightly. There was the one whose roof system with roof tiles collapsed and fell down, as shown in Photo 3.5. There was the house for combined residential and commercial use (=store

combined house) (Photo 3.6) with story shear deformation whose exterior mortar came off and wood lath under the mortar near the opening of the ventilation fan were deteriorated and attacked by termites. Such damage was confirmed in the other buildings. Most of these damage occurred along the small river, except for a few case, and it was considered that the soft ground near the river might amplify the earthquake ground motion.

The rare damage example (Photo 3.7) that only the 2nd story collapsed was observed.



Photo 3.4 Warehouse with Mud Walls damaged Heavily or Slightly



Photo 3.5 Warehouse with Mud Walls whose Roof System with Roof Tiles fell down



Photo 3.6 Store Combined House with Story Deformation



Photo 3.9 Damage of House



Photo 3.7 School Building whose 2nd Story Collapsed



Photo 3.10 Damage of House caused by the Ground Transformation (Oritate)

(3) Sendai City, Miyagi Prefecture

From the results of investigations on Oritate and Seikaen where the damage of the houses were serious, it was found that almost all of the damage of houses were caused by ground transformation. Moreover, ground transformation caused retaining wall collapse (Photos 3.8, 3.9), landslide and damage of houses (Photo 3.10). In Komatsujima, Aoba ward, drop off the mortar wall and damage of columns and by bio-deterioration and termite were observed in the house with shop (Photo 3.11).



Photo 3.11 Drop Off the Mortar Wall (Komatsujima)



Photo 3.8 Damage of Retaining Wall and Houses (Oritate, Aoba Ward)

(4) Sukagawa City, Fukushima Prefecture

A lot of damaged wood houses were found around the collapsed reinforced concrete building. For instance, they were the fallen mortar wall of the second floor of dwelling with shop (Photo 3.12), several decay and Japanese subterranean termite's damage on frame and wood sheathing of mortar wall (Photo 3.13).

The Dozo (Japanese traditional wood storehouse coated with clay and plaster finish) was greatly damaged around the hotel that the window glass

was broken, and it had residual deformation (Photo 3.14). The damage of roof's collapsing of the Dozo (Photo 3.15) was also found.

The sand eruptions from liquefied ground and the damage of the roof tile were seen here and there in some places at Minami-machi, Sukagawa City.



Photo 3.12 Fallen Mortar of Wall (Wood House with Shop)



Photo 3.13 Bio-deterioration of Column and Based Mortar



Photo 3.14 Dozo with Residual Deformation



Photo 3.15 Fallen Roof Tile of Dozo

(5) Hitachiohta City, Ibaraki Prefecture

There were a lot of damaged fence made by the Ohyaishi stone. The collapsed farm type house was observed (Photos 3.16, 3.17).



Photo 3.16 Collapsed Wood House



Photo 3.17 Breakage of Entrance Part

(6) Naka City, Ibaraki Prefecture

There were a lot of collapsed (Photo 3.18) or heavily damaged barns. The damaged house with shop was observed (Photo 3.19). The two story wood house with mortar finish collapsed at the urban area (Photo 3.20).



Photo 3.18 Collapsed Barn



Photo 3.19 Damaged House with Shop



Photo 3.20 Collapsed House

3.2.3 Concluding remarks

As a result of damage survey on the wood houses due to ground motion in Kurihara City, Osaki City, Misato Town, Ishinomaki City, Sendai City in Miyagi Prefecture, Sukagawa City in Fukushima Prefecture, Nasu Town, Yaita City in Tochigi Prefecture, and Hitachiota City, Naka City, Mito City, Joso City, Ryugasaki City in Ibaraki Prefecture, the followings were provided.

- 1) The damage on the many wood houses due to ground motion was confirmed in Osaki City in Miyagi Prefecture, Sukagawa City in Fukushima Prefecture, Nasu Town in Tochigi

Prefecture, and Hitachiota City and Naka City in Ibaraki Prefecture.

- 2) Though the seismic intensity 7 was recorded in Kurihara City, Miyagi Prefecture, it was felt that the damage on wood houses was not so much.
- 3) The damage on the wood houses caused by the failures of residential land was confirmed in Sendai City, Miyagi Prefecture, and Yaita City, Tochigi Prefecture. There were many number of the damage as such, too.
- 4) The damage of the roof tile in Fukushima and Ibaraki Prefectures was felt much larger than Miyagi Prefecture where an earthquake occurred frequently.
- 5) The possibility that the ground motion was amplified on the land filled up from meadow or rice field, even if the residential land did not fail, was suggested in Kurihara City, Osaki City in Miyagi Prefecture, Nasu Town in Tochigi Prefecture, Hitachiota City, Naka City, Joso City, Ryugasaki City in Ibaraki Prefecture, and so on.
- 6) In Osaki City, Miyagi Prefecture, the plural rare damage examples that residual story deformation of 2nd floor was larger than that of 1st floor were confirmed.

The selected individual buildings will be surveyed in detail and each of the damage causes will be discussed in future, based on the results of the damage summary of the above-mentioned wood houses.

3.3 Damage of Reinforced Concrete Buildings

3.3.1 Introduction

The Tohoku earthquake widely caused a lot of damage to buildings in Tohoku and Kanto Areas of Japan. NILIM and BRI investigated the damage of reinforced concrete (RC) buildings and reinforced concrete buildings with embedded steel frames (referred to as steel reinforced concrete, or SRC) in the affected areas where the earthquake intensity was classified as JMA seismic intensities 6+ and 6- in Iwate, Miyagi, Fukushima and Ibaraki Prefectures. The objective of the field investigation was to see the picture of the outline of the overall damage on

the buildings and to classify the damage pattern of them. The survey was conducted several times from March 14 to the middle of May in the areas as shown in Fig. 3.2. The outline of the investigation is described below.

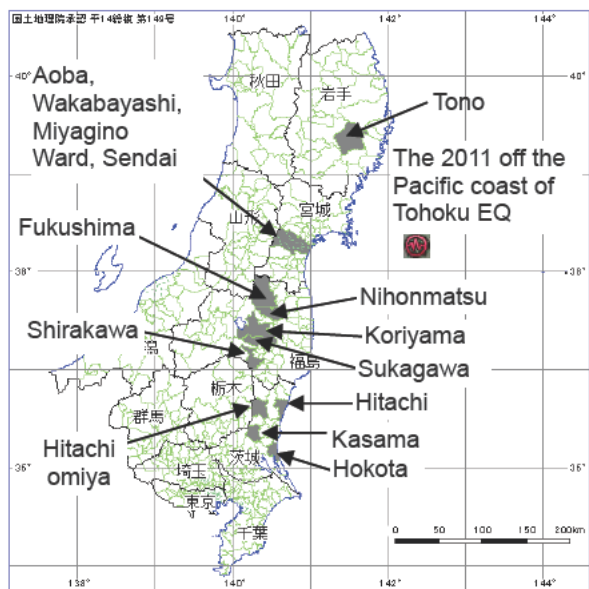

Fig. 3.2 Investigated Area (add a postscript on KenMap)

3.3.2 Characteristics of damage on RC buildings

In the earthquake, strong earthquake motions were observed in various locations of the Tohoku and the Kanto Areas and caused various types of damage in a wide area. At the same time, the damage concentrated on specific areas was not seen generally. In general, we had the impression that structural damage was not particularly great in comparison with JMA seismic intensities measured in the locations. Consequently, there is not a significant difference in damage situations among the locations. However, the damage to structural members was somewhat concentrated on limited areas, such as Wakabayashi Ward in Sendai City and Sukagawa City. It is known that these areas formed paddy fields or moats. Therefore, it can be well estimated that ground conditions in the areas possibly contributed to the damage.

The types of structural damage on RC buildings identified by the field surveys are those that had been observed in past earthquake damage

investigations. Some serious types of damage were observed, such as story collapse of low-rise buildings, collapse of soft-first story (pilotis), and the loss of vertical load carrying capacity of columns due to shear failure. Most of severely damaged buildings were designed with the previous seismic design code that was governed before June 1981. Some SRC buildings designed under the current seismic design code, which has been coming into force after June 1981, caused damage of buckling of their longitudinal reinforcements near base plates at the bottom of column. The same damage is known to have occurred also in the Kobe earthquake. In addition, buildings designed under the current seismic design code were confirmed to have no collapse but some damage like shear cracks at their beam-column joints or horizontal cracks at their concrete placing joints.

The types of the damage of RC and SRC buildings that were observed through the site investigation are classified into those for structural and nonstructural elements in the following.

- A) Damage of structural elements
 - A-1) Collapse of first story
 - A-2) Mid-story collapse
 - A-3) Shear failure of columns
 - A-4) Flexural failure at the bottom of column and base of boundary columns on multi-story shear walls
 - A-5) Pullout of anchor bolts and buckling of longitudinal reinforcements at exposed column base of steel reinforced concrete (SRC) buildings
 - A-6) Shear failure or bond splitting failure of link beams of multi-story coupled shear walls
 - A-7) Building tilting
 - A-8) Destruction, failure or tilting of penthouses
 - A-9) Damage of seismic retrofitted buildings
- B) Damage of nonstructural elements
 - B-1) Flexural failure at the bottom of column with wing wall
 - B-2) Damage of nonstructural wall in residential building

- B-3) Damage and falling of external finishing
- B-4) Tilting or dropout of components projecting above the roof
- B-5) Collapse of concrete block wall and stone masonry wall

3.3.3 Damage of structural elements

A-1) Collapse of first story

The 3-story RC building which was at the intersection in Sukagawa City, having a few walls on the facade on the first story and many walls on the back of the first story and the second story and higher, was severely damaged on the first story. The corner columns faced the intersection were significantly destroyed. The loss of axial load carrying capacity of the first-story columns caused the drop of the second and higher stories (Photos 3.21 and 3.22).



Photo 3.21 First-story Collapsed Building

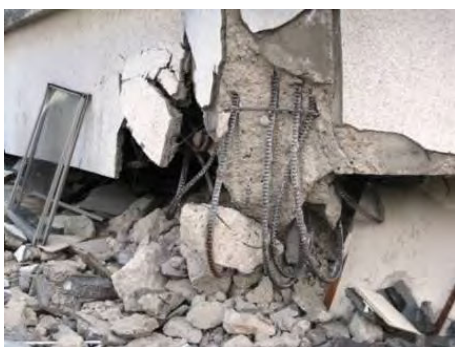

Photo 3.22 Close-up View of the Fallen Story

A-2) Mid-story collapse

The 3-story office building in Wakabayashi Ward, Sendai City partially collapsed on the second story and tilted (Photo 3.23). Only the second

story has openings on the wall at the gable side, as shown on the left wall of Photo 3.23. For this reason, it was assumed that the openings were intensively deformed and resulted in shear failure of the short columns formed by hanging and spandrel walls. Shear failure of the long columns on the third story was observed possibly due to the effect of the collapse of the second story. Damage of the columns and beams on the first story was not seen, while shear cracks were observed on the nonstructural walls.



Photo 3.23 Mid-story Collapsed Building

A-3) Shear failure of columns

The shear failure occurred on the first-story columns in the two-story RC building in Aoba Ward, Sendai City (Photos 3.24 and 3.25). Some columns of the building were intact after the main shock on March 11, but aftershocks caused shear failure to some of them, as shown on the right of Photo 3.25. It was confirmed that the aftershocks accelerated the damage level of this building.



Photo 3.24 Appearance of Damaged Building

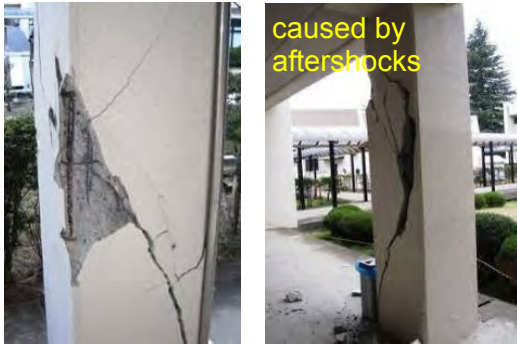

Photo 3.25 Shear Cracks on First-story Columns

The 3-story RC building constructed in 1964 on a hill in Kasama City suffered also damage. Cracks in the ground were observed around the building. As seen in the photo, the RC structure on the first story was greatly damaged. Shear failure occurred on many exterior columns, which were made shorter in clear height by the hanging and spandrel walls without structural slit, as shown in Photo 3.26. In addition, the failures of the shear walls with openings were observed (Photo 3.27)

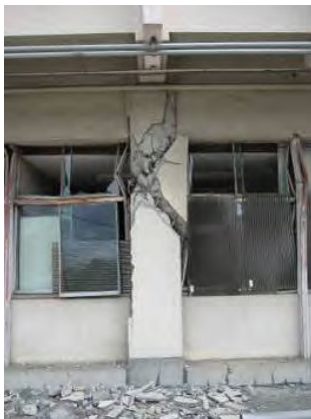

Photo 3.26 Shear Failure of Column



Photo 3.27 Shear Failure of Wall with Opening

A-4) Flexural failure at the bottom of column and base of boundary columns on multi-story shear walls

The building that consists of 9-story SRC and 2-story RC structures in Aoba Ward, Sendai City suffered from the earthquake (Photo 3.28). In the high-rise building, the multi-story shear wall on the gable side was subject to flexural failure at the third floor. Crushing of concrete and buckling of the longitudinal reinforcements were observed at the bottom of the boundary column of shear wall, as shown in Photo 3.29. This building was also damaged by the Miyagi-Ken-Oki earthquake in 1978 and had been retrofitted.



Photo 3.28 Appearance of Damaged Building



Photo 3.29 Crushing at the Bottom of Column on the Multi-story Shear Wall

A-5) Pullout of anchor bolts and buckling of longitudinal reinforcements at exposed column base of steel reinforced concrete (SRC) buildings

The damage at the bottom of SRC column and shear wall was observed too on the building in Shirakawa City (Photo 3.30), which was

composed of RC and SRC structures. Pullout of anchor bolts of the exposed-type column base was detected. In consequence, the reinforcing bars were forced to stretch large and the buckling of them occurred around the base plate, as shown in Photo 3.31.

This type of damage was observed not only in buildings designed under the previous seismic design code but also in some buildings done under the current seismic design code.



Photo 3.30 Damage on the Bottom of SRC Column and Shear Wall



Photo 3.31 Close-up View of the Bottom of SRC Column

A-6) Shear failure or bond splitting failure of link beam of multi-story coupled shear walls

The shear failure or bond splitting failure occurred on the link beam connecting coupled shear walls from low-rise to high-rise stories on the 8-story RC building in Aoba Ward, Sendai City, as shown in Photo 3.32. The link beams has two openings at the center of them, and were damaged around these parts (Photo 3.33).



Photo 3.32 Appearance of Damaged Building



Photo 3.33 Damage on Boundary Beam with Opening

A-7) Building tilting

Photo 3.34 shows a residential building that sank and leaned in the longitudinal direction in Shirakawa City. The balcony, of which height above ground level was about 77cm, went down to ground surface in the gable side, as shown in Photo 3.35. Significant settlement was observed too on foot walk in surrounding area.



Photo 3.34 Appearance of Sank and Leaned Building



Photo 3.35 Sank Balcony

A-8) Destruction, failure or tilting of penthouses

The damage on penthouses was observed everywhere, like tilting of it in Aoba Ward, Sendai City, as shown in Photo 3.36.



Photo 36 Damaged Penthouse

A-9) Damage of seismic retrofitted buildings

Photo 3.37 shows the 2-story RC office building constructed in 1969 in Hitachiomiya City. The building was retrofitted with framed steel braces in the longitudinal direction in 2003, because the seismic index of structure, I_s on the first story of

the building was below the seismic demand index of structure, I_{s0} by the seismic evaluation method [3.3]. Meanwhile, the building in the span direction was not retrofitted, as a consequence of that the seismic index of structure in the direction satisfied the seismic demand index of structure. The steel braces are eccentrically installed to the center axis of the beams and columns.

Shear cracks occurred on the columns with the framed steel braces at the earthquake, as shown in Photo 3.38, although the remarkable damage such as yield of steel were not seen on the braces.



Photo 3.37 Appearance of Damaged Building

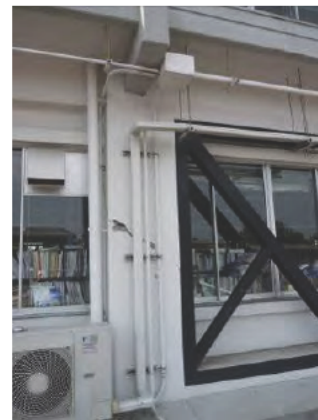

Photo 3.38 Shear Crack on Column with Framed Steel Braces

There were many seismic retrofitted buildings including school buildings in the affected areas where the great earthquake motions were observed. Based on the results of our investigation, these retrofitted buildings were hardly damaged or slightly harmed, it means that the seismic strengthening on existing buildings worked effectively against the earthquake.

3.3.4 Damage of nonstructural elements

B-1) Flexural failure at the bottom of column with wing wall

The separation of cover concrete at the bottom of wing wall was observed on the 5-story RC building constructed in 2007 in Sukagawa City (Photo 3.39). In here, we classified this as the damage of nonstructural elements, because the wing wall is generally designed as the nonstructural element, which is not expected to resist the external force.

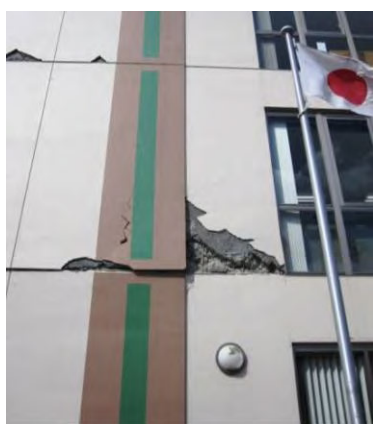

Photo 3.39 Separation of Concrete of Wing Wall

B-2) Damage of nonstructural wall in residential building

The nonstructural walls around the front doors from low-rise to top floors were subject to shear failure, while the doors were deformed on the 10-story SRC residential building constructed in Aoba Ward, Sendai City in 1996, as shown in Photos 3.40 and 3.41. In addition, shear cracks were observed on the mullion walls on balconies in some of the low-rise floors.

The shear cracks on the mullion walls also occurred in the 8-story RC hotel in Sukagawa City (Photo 3.42).

The cases where shear cracks occurred on the nonstructural walls around the front door or on the mullion wall on the balcony were relatively often observed in urban residential buildings, regardless of the seismic design codes applied to.



Photo 3.40 Appearance of Damaged Building



Photo 3.41 Shear Failure of Nonstructural Wall



Photo 3.42 Shear Crack on Nonstructural Wall

B-3) Damage and falling of external finishing

Photos 3.43 show the case where the autoclaved lightweight aerated concrete (ALC) panel on the upper floor in the 8-story building fell away, and Photo 3.44 is the case where the tile on exterior wall was dropped, in Aoba Ward, Sendai City.

These kinds of damage relatively often occurred in buildings without structural damage, not limited to specific areas. Despite of the

construction period and the seismic design codes applied to, these damage are often seen in many buildings.



Photo 3.43 Dropped ALC Panels from 8 Story



Photo 3.44 Damage of Tile on Exterior Wall

B-5) Collapse of concrete block wall and stone masonry wall

The collapse of concrete block wall and stone masonry wall are well known as earthquake damage caused by strong seismic motion. The damage of those was often observed in the field investigation, as shown in Photos 3.45 and 3.46.



Photo 3.45 Collapse of Concrete Block Wall



Photo 3.46 Collapse of Stone Masonry Wall

3.3.5 Concluding remarks

We classified the types of damage of reinforced concrete (RC) and steel reinforced concrete (SRC) buildings that were caused by earthquake motions under the Tohoku earthquake, and described the damage on structural and nonstructural elements. As mentioned early, almost all of the types of damage were observed in past destructive earthquakes such as the Kobe earthquake in 1995 and the Mid Niigata Prefecture earthquake in 2004. However, the following types of structural damage that were observed in the Kobe earthquake have not been confirmed within the scope of the investigation conducted so far.

- Story collapse of soft-first story building designed under the current seismic design code
- Mid-story collapse in mid-rise and high-rise buildings
- Overturning of buildings
- Failure of beam-column joint in building designed under the current seismic design code
- Fracture of pressure welding of reinforcements
- Falling of pre-cast roof in gymnasium

In general, there are only a few cases of serious structural damage that was caused by earthquake motions. On the contrary, it was the remarkable cases caused by the earthquake that public buildings like city hall under the past seismic design code suffered from severe damage and could not be continuously used. The main cause of the damage on these buildings was the loss of the vertical load carrying capacity due to shear

failure of short columns. The fact makes us reconfirm that seismic retrofit on these buildings is particularly important, which must be operated as the disaster-prevention facilities.

3.4 Damage of Steel Gymnasiums

3.4.1 Introduction

The damage of general steel buildings such as offices and shops caused by the Tohoku earthquake in the areas of Ibaraki, Fukushima and Miyagi Prefectures with JMA seismic intensity around 6 was investigated for some two weeks after the earthquake. The structures of steel buildings are generally covered with exterior cladding and interior finishing. For this reason, the real situations of the damage to columns, beams and braces may not be correctly determined under the exterior damage investigation. Therefore, the damage investigation on steel gymnasiums whose structural members are generally exposed was considered and conducted. The damage investigation for such steel gymnasiums was carried out in the areas of Ibaraki Prefecture with JMA seismic intensity around 6. This section describes the outline of the damage investigation for the steel gymnasiums.

3.4.2 Outline of damage investigation for steel gymnasiums

i) Outline of damage investigation for high school gymnasiums in Ibaraki Prefecture

Gymnasiums designed under the previous seismic code were greatly damaged in the Mid Niigata Prefecture earthquake in 2004, but most of them under the current seismic code were not damaged [3.4, 3.5, 3.6]. Consequently, as the subject of the damage investigation, steel gymnasiums constructed under the previous seismic code were mainly chosen. The investigation covered a wide range of areas in Ibaraki Prefecture where JMA seismic intensity 5+ to 6+ was recorded (Ooarai Town, Shirosato Town, Hitachi City, Mito City, Naka City, Hitachinaka City, Chikusei City, Kasama City, Hokota City, Tsuchiura City, Bando City, Koga City, Shimotsuma City and Joso City).

The main purpose of the investigation is to determine what damage pattern was often distributed in these areas and in which area the pattern was often distributed. A total of 44 gymnasiums in high schools were chosen and investigated.

ii) Outline of damage investigation for elementary and junior high school gymnasiums in Mito City

In general, building size (total floor area) of high school gymnasiums seems to be larger than elementary and junior high school gymnasiums. In order to know an effect of building size on earthquake damage situation, damage investigation of elementary and junior high school gymnasiums was considered and conducted. The result of the damage investigation for the high school gymnasiums in Ibaraki Prefecture showed that the areas around Mito City suffered relatively larger structural damage than other areas. Then, Mito City was chosen for the survey area of the damage investigation for gymnasiums in elementary and junior high school. A total of 22 gymnasiums in elementary and junior high school constructed under the previous seismic code in Mito City were investigated.

3.4.3 Classification and characteristics of damage of steel gymnasiums

For this earthquake damage investigation, a total of 66 gymnasiums in the high schools within Ibaraki Prefecture and in the elementary and junior high schools within Mito City were surveyed. The damage of the gymnasiums was classified into the types of (1) to (7). The types of (1) to (6) and the type of (7) refer to structural damage and to nonstructural one, respectively.

- (1) Buckling and fracture of brace member and fracture of its joint
- (2) Buckling of diagonal member of latticed column
- (3) Damage of connection (bearing support part) between RC column and steel roof frame
- (4) Deflection, buckling and fracture of roof horizontal brace
- (5) Cracking of column base concrete
- (6) Other (Overturning of floor strut, etc.)

(7) Nonstructural damage such as dropping of ceilings and exterior walls and breakage of windows

Each damage photograph is shown for each damage type in the following.

(1) Buckling and fracture of brace member and fracture of its joint

Buckling of brace member (Photo 3.47) and fracture of brace joint (Photos 3.48-3.50) were observed. Angle section was often used for many brace members, but circular hollow section steel (Photo 3.49) was also used for brace members. Fractured sections include steel plate inserted into steel pipe, end of bracing member and section loss part by bolt hole. These types of the damage are classified into the severe damage category based on the damage evaluation standard [3.7]. The gymnasiums constructed under the previous seismic code that were severely damaged by the Mid Niigata Prefecture earthquake in 2004 had accounted for about 30% of the total [3.4, 3.5, 3.6]. It is impressed that a rate of the gymnasiums severely damaged by the Tohoku earthquake was lower than by the Mid Niigata Prefecture earthquake in 2004.



Photo 3.47 Buckling of Brace



Photo 3.48 Net Section Fracture at Bolt Hole



a) Fracture at column top b) Fracture at brace crossing
Photo 3.49 Fracture of Brace Welded Connection



Photo 3.50 Fracture of Bolts

(2) Buckling of diagonal member of latticed column

In one of the investigated gymnasiums, buckling of diagonal members in some latticed columns was observed (Photo 3.51). Damage of column buckling caused in steel frames for span direction caused in steel frames for span direction had not been observed under the damage investigations of the Mid Niigata Prefecture earthquake in 2004 [3.4, 3.5, 3.6].



a) Latticed column b) Buckling of diagonal member
 Photo 3.51 Buckling of Diagonal Member of Latticed Column



Photo 3.53 Fracture of Horizontal Brace

(3) Damage of connection (bearing support part) between RC column and steel roof frame

In the investigated gymnasiums, exposure of anchor bolts due to spalling of the concrete at connection (bearing support part) between the RC column and steel roof frame (Photo 3.52), spalling of finish mortars on the RC column at the roof bearing support part, pullout of hole-in anchors were observed. This type of the damage was observed in some gymnasiums in this damage investigation.



Photo 3.52 Spalling of Concrete

(4) Deflection, buckling and fracture of roof horizontal brace

Roof horizontal braces were damaged in 2 high school gymnasiums and 5 elementary and junior high school gymnasiums. Such damage mainly occurred at horizontal braces with turnbuckles; obvious deflection of the horizontal brace, fracture at thread and fracture of bolt connections were observed (Photo 3.53).

(5) Cracking of column base concrete

Damage of cracking of the column base concrete and mortar in the gallery of some gymnasiums was observed (Photo 3.54). Concrete and mortar of steel column base at a ground level was also cracked. However, almost all of these cracking are classified into minor or slight damage.



Photo 3.54 Cracking of Column Base Concrete

(6) Other (Overturning of floor strut, etc.)

As the other types of the structural damage, the following damage was observed; (a) overturning of floor strut (Photo 3.55), (b) tilting of concrete block self-standing wall and (c) peeling of paints of beam member which was observed near the top of the V-shaped roof beam or arch beam (Photo 3.56). In terms of the peeling of paints, it is undetermined whether a yielding occurred to the beam member or not.



Photo 3.55 Overturning of Floor Strut



Photo 3.58 Dropping of Ceiling Materials



Photo 3.56 Peeling of Paints of Beam



Photo 3.59 Breakage of Windows

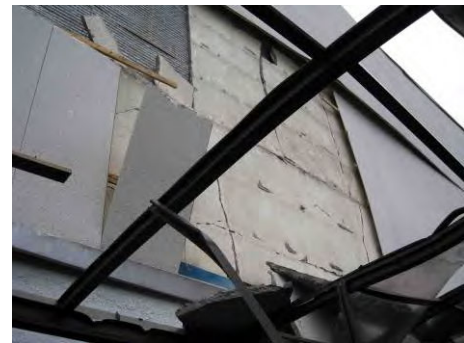

Photo 3.60 Falling of Exterior Finish Materials

(7) Nonstructural damage such as dropping of ceilings and exterior walls and breakage of windows

The types of nonstructural damage of gymnasiums include dropping of ceilings and lighting equipment (Photos 3.57 and 3.58), breakage of windows (Photo 3.59), dropping of exterior walls (Photo 3.60), dropping of interior walls and eave soffit. In particular, the severe damage such as dropping of extensive ceiling in the high school gymnasiums was observed than in the elementary and junior high school gymnasiums.



Photo 3.57 Dropping of Ceiling Materials

3.4.4 Concluding remarks

Damage of the steel gymnasiums constructed under the previous seismic code in the areas with JMA seismic intensity around 6 in Ibaraki Prefecture was investigated, and the outline of the investigation was described in this section. The results of the damage investigation of the steel gymnasiums are summarized as follows.

a) Structural damage of the steel gymnasiums

1) The types of observed structural damage of the gymnasiums are classified into the following six categories. (1) Buckling and fracture of brace member and fracture of its joint, (2) Buckling of diagonal member of latticed column, (3) Damage of connection (bearing support part) between RC column and steel roof frame, (4) Deflection, buckling and fracture of roof horizontal brace,

(5) Cracking of column base concrete, and (6) Other (overturning of floor strut, etc.).

2) In 3 of the investigated 66 gymnasiums, severe structural damage such as "fracture of brace member and joint" occurred. This rate of the damage seems to be smaller than that in the Mid Niigata Prefecture earthquake in 2004.

3) Severe structural damage was observed in Mito City, Hokota City and Naka City than in other areas.

b) Nonstructural damage of the steel gymnasiums

1) The types of observed nonstructural damage include dropping of ceilings, dropping of exterior and interior walls, falling of eave soffit and breakage of windows.

2) In 4 of the investigated gymnasiums, ceiling materials were extensively dropped, which is classified into the severe damage category. In some of the gymnasiums, many windows were broken.

3) Severe nonstructural damage was observed in Mito City, Hokota City and Hitachi City than in other areas.

4) Severe structural and nonstructural damage seems to occur in the high school gymnasiums rather than in the elementary and junior high school gymnasiums.

3.5 Damages due to Failures of Residential Land

3.5.1 Introduction

This section reports the outline of damage situations associated with liquefaction in the catchment basin area of Tone River on the border between Ibaraki and Chiba Prefectures and in Urayasu City, Chiba Prefecture, and the outline of damage situations of developed housing area in Miyagi and Fukushima Prefectures.

3.5.2 Liquefaction damage of catchment basin area of Tone River

Damage associated with liquefaction has occurred in the same areas as in the areas where liquefaction was reported in past earthquakes, such as old river channel, reclaimed lagoon, reclaimed pond and reclaimed paddy field. This section describes the damage situations in Nishishiro, Inashiki City, in Hinode, Itako City and in Kamisu City within Ibaraki Prefecture. For reference, liquefaction damage in Nishishiro, Inashiki City and in Hinode, Itako City was reported after the 1987 East off Chiba Prefecture earthquake.

(1) Nishishiro, Inashiki City in Ibaraki Prefecture

Large-scale and extensive damage occurred within the zone of about 500 m four directions that encloses Route 51 of National Highway and Yokotone River on the east of the road. Route 11 of Prefectural Road was closed to vehicles, and sand boiling, great road upheaval or severe fissure that is associated with liquefaction was seen mainly along the road. As a ground transformation, the ground subsided up to about 40 cm, and transversely moved up to about 1 m. Private automobile were buried in boiled sand to the extent of a half of height of their tires. This indicates a great amount of sand boil.

Finishes of the sidewalks around a large-scale commercial establishment along Route 11 of Prefectural Road were scattered. The subsidence of the surrounding ground was about 40 cm, and the settlement of the facility in itself was slight. The commercial building was tilted about 0.7/100 in the longitudinal direction. We visually observed a foundation type of the building from an opening between surrounding fissures. The type was confirmed to be a pile foundation (Photo 3.61).



Photo 3.61 Situations around the Commercial Building and State of Pile Head

Sand boiling was seen everywhere on the roads or sites also in surrounding buildings lots. A house constructed on an embankment was tilted to an adjacent warehouse with sand boiling. An angle of tilting was 5.0/100 (Photo 3.62). It can be assumed that liquefaction occurred at the concentration of the loads of two adjacent buildings and the house was tilted to the direction.



Photo 3.62 House Tilted 5.0/100

(2) Hinode, Itako City in Ibaraki Prefecture

In Hinode, large-scale damage occurred in on corner within the zone of about 200 m four directions near Hitachi-tone River. Sand boiling, lift of buried structures, and subsidence or tilting of power poles, which were caused by liquefaction, were seen everywhere on the road and sites. Many buildings facing the road subsided 20 to 30 cm from the front sidewalk (Photo 3.63). For reference, foundation cracks or gaps were not observed in the investigated range.



Photo 3.63 Subsidence of Two Houses enclosing Vacant Land

3.5.3 Liquefaction damage in Urayasu City, Chiba Prefecture

A reclaimed ground accounts for 3/4 of a gross area in Urayasu City at present. The southern part of this city is an area that was developed under a reclamation project using sea sand. In the result, the area consists of a weak layer up to GL-40m. For reference, liquefaction damage was reported after the 1987 East off Chiba Prefecture earthquake. The damage situations are given below.

(1) Mihama

In Mihama, subsidence and tilting that was caused by liquefaction were observed in a house that has a dry area in a basement (Photo 3.64). An angle of tilting of the house was about 3 degrees. It is considered that the basement was lifted and another remaining parts of the house subsided. Around this house, a house's site was totally covered with boiled sand, and a fence's foundation was deformed. In addition, a carport in one building was ruptured by liquefaction and moved (Photo 3.65). A unit of the carport and the building was separated and moved about 50 cm probably due to the movement of the ground associated with liquefaction.

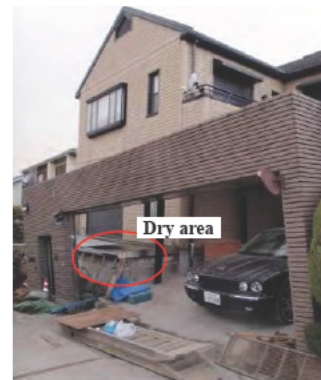

Photo 3.64 Tilted House



Photo 3.65 Moved Carport

(2) Irifune

In Irifune, a difference in settlement between adjacent buildings on spread and pile foundations was observed. The building on spread foundation subsided about 35 cm from the front sidewalk, while the building on pile foundation was elevated about 30 cm (Photo 3.66). Other settled and tilted buildings were dotted

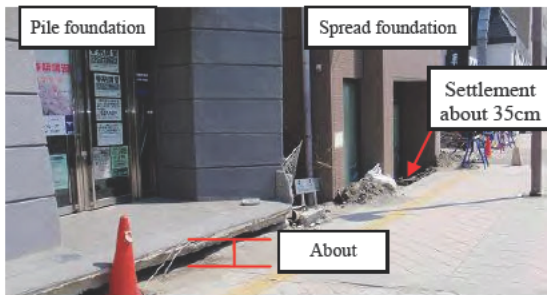

Photo 3.66 Difference in Damage between Support Mechanisms

6.5.4 Damage of developed housing area

The damage investigation for developed housing area was conducted in some areas of Miyagi, Fukushima and Tochigi Prefectures, but the damage in Miyagi and Fukushima Prefectures is reported in this section.

(1) Near 5-chome, Oritate, Aoba-ku, Sendai City, Miyagi Prefecture

In one corner of a large-scale housing area, where a slope in the N-NE direction had been developed, ground transformation by sliding of the housing site embankment to the slope direction, and damage to the retaining walls by ground transformation were often observed (Photo 3.67). Houses on the site were recognized to have different damage patterns, such as movement, subsidence and tilting without

structural damage, structural great deformation and fractured foundation.



Photo 3.67 Damage of Retaining Wall and House Movement and Tilting by Sliding and Ground Transformation

(2) Near Aoyama 2-chome and Midorigaoka 4-chome, Taihaku-ku, Sendai City, Miyagi Pref.

This area is located at one corner of a large-scale housing area where a contoured hill was developed. Ground transformation by sliding of the housing site embankment to the slope direction, and damage to the retaining walls by ground transformation, were often observed. The damaged area at 4-chome, Midorigaoka under this earthquake was almost same as under the 1978 Miyagi-Ken-Oki earthquake. The land at 2-chome, Aoyama is wavier than at 4-chome, Midorigaoka. Near the zone of 2-chome, Aoyama, large-scale sliding of the embankment occurred (Photo 3.68). In this zone, large deformation and damage were seen on both of upper structures and foundations of houses on the housing area. In other places with embankment sliding, deformation and damage of upper structures of houses were observed, but it seemed that there was limited significant damage to foundations. Near 2-chome, Aoyama, a retaining wall for the housing area with a height of over 5 m was damaged.



Photo 3.68 Group of Houses damaged by Sliding and Ground Transformation

(3) Near Numanoue, Fushigami, Fukushima City, Fukushima Prefecture

This area is located at one corner of a large-scale housing area where a hill was developed. The result of visual inspection showed ground transformation by land sliding on the slope of the hill. This ground transformation caused serious damage to houses. In the result, some houses were in a state of sliding on the slope of the hill (Photo 3.69). On the other hand, houses near the top of the hill suffered only damage associated with slight transformation of housing area embankment.



Photo 3.69 Land Sliding on Slope on the Southwest of the Hill and Sliding House

3.5.5 Concluding remarks

The outline of the damage situations in the investigate scope is as follows.

1) Damage caused by liquefaction:

In the catchment area of Tone River and the coastal zone of Tokyo Bay, extensive damage such as sand boiling or ground transformation associated with liquefaction was confirmed. Highly tilted buildings were seen, but visual cracks or fissures on the foundations investigated were not observed.

2) Damage to housing area:

Large damage with transformations such as ground sliding was observed mainly in the elevated and developed housing area (particularly marginal part). In some areas, transformations occurred again in the developed lots that had been affected by the past earthquakes.

3.6 Response of Seismically Isolated Buildings

3.6.1 Introduction

Miyagi Prefecture and nearby areas have experienced disastrous earthquakes frequently, therefore, reflecting high consciousness of earthquake risks, there are many seismically isolated buildings (SI buildings) constructed in those areas. Investigation team was dispatched on July 1st and 2nd in 2011 to observe performance of SI buildings during the Tohoku earthquake and ask persons in charge of the buildings about the damage. In total, 16 SI buildings in Miyagi Prefecture and 1 building in Yamagata Prefecture were investigated.

3.6.2 Behavior of SI buildings

(1) SI building A

i) Building information

The SI building A is a reinforced concrete office building with 9-story super-structure and 2-story basement, located in Miyagino in Sendai City (Photo 3.70). The building was retrofitted by using base isolation technique putting isolation devices on the top of columns in B1F. The floor plan has the 26.4 m × 54 m rectangular shape and 40 high-damping rubber bearings (HRBs) are installed.

ii) Building performance during earthquake

Observation results are summarized as follows:

- a) According to the person in charge of the building, no furniture was turned over and no structural damage was observed.
- b) However, some damage was observed at the cover-panels of fire protection and the expansion joints near the boundary between isolated and non-isolated floors (Photo 3.71). It seems that parts of expansion joints were not well operated due to the large displacement of SI building floor during earthquake.
- c) The ground surrounding the building partially subsided around 10 cm.

iii) Earthquake motion records

This building has accelerometers at B2F, 1F and

9F (top floor). Also, there is a scratch board in B1F to record the displacement of isolation floor. Furthermore, there is an accelerometer installed by JMA in the basement of an adjacent building. The maximum acceleration values of these accelerometers at main shock are listed in Table 3.1.

From the trace on the scratch board installed on the SI building floor, the maximum displacement was estimated as around 18 cm at the main shock (on March 11, 2011) and around 10 cm at the aftershock (on April 7, 2011).



Photo 3.70 Overview of SI Building A



(a) Damage to the panel



(b) Damage to the expansion joint

Photo 3.71 Damage near the Boundary between Isolated and Non-isolated Floors

Table 3.1 Maximum Acceleration Values

Location	Direction		
	NS [gal]	EW [gal]	Vertical Z [gal]
Basement of adjacent bldg.	409.9	317.9	251.4
B2F (below SI)	289.0	250.8	234.9
1F (above SI)	120.5	143.7	373.7
9F	141.7	169.9	523.9

(2) SI building B

i) Building information

The SI building B is a 14-story reinforced concrete building used for condominium, located in Miyagino in Sendai City (Photo 3.72). The building has the U-shape plan and the corners of the building are separated by expansion joints. The NRBs, Lead dampers, U-shape steel dampers are installed in the SI floor.

ii) Building performance during earthquake

Observation results are summarized as follows:

- According to the person in charge of the building, no furniture was turned over and no structural damage was observed inside of rooms. However, the damage to the expansion joint was observed.
- Drop of the ceramic tiles on outer wall (Photo 3.73) and shear crack on the wall in the first floor parking space (Photo 3.74) were observed. The subsidence of ground around 10 cm was observed near the building.
- No damage was found to NRBs by visual inspection (Photo 3.75), however, paint of U-shape dampers was peeled off (Photo 3.76) and many cracks were found on Lead dampers (Photo 3.77).



Photo 3.72 Overview of SI building B



Photo 3.73 Drop of Ceramic Tiles



Photo 3.74 Shear Crack on the Wall



Photo 3.75 NRB



Photo 3.76 U-shape Steel Damper

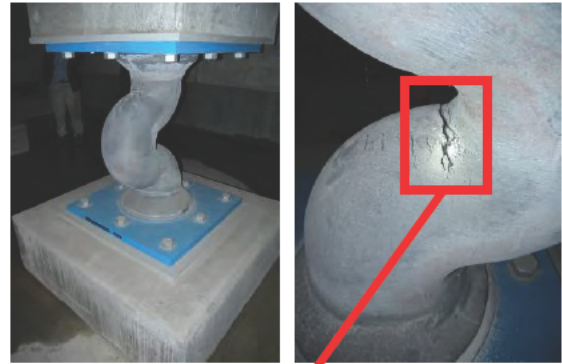

Photo 3.77 Lead Damper and Crack on the Surface

3.6.3 Concluding remarks

Investigation results of SI buildings in Miyagi Prefecture and one SI building in Yamagata Prefecture is summarized as follows:

- a) Super-structures of SI buildings suffered almost no damage even under strong shaking with JMA intensity 6 upper. It verifies the excellent performance of SI buildings.
- b) There are 8 buildings with scratch boards to measure displacement of the SI building floor. In most cases, the maximum displacement has been estimated as around 20 cm. There is one case with the maximum displacement estimated over 40 cm.
- c) In some buildings, damage was observed at the expansion joints. It seems that parts of expansion joints were not well operated due to the large displacement of SI building floor during earthquake.
- d) Subsidence of ground around the building was observed in some buildings.
- e) Many cracks were found in lead dampers. These cracks might be increased by the aftershocks.
- f) Peeling off of paint was observed widely for U-shape steel dampers. In some cases,

residual deformation of steel was remained.

3.7 Conclusion

This section summarizes results of damage of buildings due to earthquake motion through surveys on wood houses, steel buildings, reinforced concrete buildings, residential land, foundation, non-structural elements and seismically isolated buildings. The results can be summarized as follows even though it is in the stage of the Quick Report.

1) Wood houses: The damages of upper structure were confirmed in several areas however the damage of wood houses seems not so heavy as an impression in Kurihara City where seismic intensity 7 was recorded. Many damages of structure were observed due to deformation of developed residential land in Sendai City, Miyagi Prefecture and Yaita City, Tochigi Prefecture. The damage of roof tiles could be more observed in both Fukushima and Ibaraki Prefectures than in Miyagi Prefecture where earthquakes were frequently occurred since the 1978 Miyagi-Ken-Oki earthquake. The damage types are almost similar to those of the past earthquakes.

2) Steel frame structures: There was almost no damage of main steel structure members such as columns and beams. Damages of vertical braces' rupture etc. were observed in the school gymnasium that was constructed in the years of old seismic code (before 1981) however the damage ratio is smaller than the case of the Niigata-Ken Chuetsu earthquake in 2004. On the other hand, damages of non-structural elements including falling of ceilings were observed comparatively more than the past cases.

4. DAMAGE TO BUILDINGS IN INUNDATION AREAS DUE TO TSUNAMI

4.1 Purpose of Investigation

The purpose of this investigation is to understand an overview of buildings damaged by tsunami, to

3) Reinforced concrete structures: Most of structural damages in reinforced concrete structure were observed in the buildings designed based on the old seismic codes. Though the number of damaged buildings is not large compared to the seismic intensity, damage types were mostly similar to the past seismic damages that include severe damage such as loss of axial force bearing capacity due to shear failure of columns.

4) Residential land, Foundation: One of the observed characteristics is liquefaction in wide areas that could not be occurred in the past earthquakes in Japan. Researches on the mechanism and considerations of counter-measures will be necessary not only for individual buildings but also for infrastructure like roads and water supply and sewage systems. In a part of residential land, heavy damage such as collapse of ground was observed equal to the past damaged earthquakes.

5) Damages of non-structural elements of comparatively old construction types were confirmed in many cases. In addition, break and falling of non-structural elements at rather higher parts were also confirmed.

6) Seismically isolated buildings: Super-structures of SI buildings suffered almost no damage. However, damage was observed at the expansion joints in some buildings. Also, many cracks in lead dampers and peeling off of paint of U-shape steel dampers were found.

obtain basic data and information required to evaluate mechanisms for causing damage to the buildings and to contribute to tsunami load and tsunami-resistant designs for buildings such as tsunami evacuation buildings, by means of collecting building damage cases by tsunami, classifying the damage patterns for different

structural categories, and making a comparison between the calculated tsunami force acting on buildings and the strength of the buildings.

The NILIM and BRI jointly created a tsunami damage investigation team⁴ that consists of 27 members. The joint team collected national and international standards and codes concerning tsunami evacuation buildings and tsunami loads and surveyed about 100 buildings and structures in three site investigations.

4.2 Summary of Damage in Inundation Area Due to Tsunami

Table 4.1 gathered up the damage statistics of main cities, towns and villages, 49 local governments in six prefectures, in the tsunami inundation area based on a survey by Fire and Disaster Management Agency (FDMA) on August 11, 2011 [4.1]. As for the dwelling house damage, about 106,000 houses were completely destroyed or missing, about 100,000 houses were partially damaged, about 106,000 houses were below partially damaged, and totally about 370,000 houses were damaged and 160 fires occurred in this area. Each number of complete destruction or missing of houses of Ishinomaki or Sendai City in Miyagi Prefecture is more than 19,000. That of Kesen-numa City in Miyagi Prefecture is more than 8,500. Those of Higashimatsushima City in Miyagi Prefecture and Minamisoma City in Fukushima Prefecture are more than 4,500. Those of Miyako City, Kamaishi City, Rikuzentakata City in Iwate Prefecture and Minamisanriku Town in Miyagi Prefecture are more than 3,000. There are areas which suffered serious damage in Iwate, Miyagi and Fukushima Prefectures.

4.3 Classification of Damage Patterns

4.3.1 Reinforced concrete buildings

(1) Collapse of first floor

A case where column capitals and bases on the first floor in a building were subject to flexural failure and subsequently to story collapse was seen in two-story buildings (Photo 4.1).

These buildings have a column-to-beam frame. The first floor has a relatively small number of walls, but many concrete block walls are placed on the second floor. The first and second floors of the building in Photo 4.1 are used as shop and dwelling, respectively. The relevant buildings are estimated to have structural characteristics of low strength and stiffness on the first floor. As an opening on the second floor is not large, it is assumed that the second floor suffered a large tsunami wave pressure and the shear force acting on the first floor exceeded the lateral load-bearing capacity, resulting in the collapse of the building. Story collapse of the first floor has not been observed in 3-story or higher buildings in the past investigations. In 3-story buildings, in general, reinforced concrete walls are often used for the first floor. For this reason, the strength of the first floor is considered to have been larger.



Photo 4.1 Story Collapse of 2-story Reinforced Concrete Building

⁴ Damage Investigation Team (The members' positions as of April 20, 2011) - National Institute for Land and Infrastructure Management, Ministry of Land, Infrastructure and Transport (8 members): Isao Nishiyama, Akiyoshi Mukai, Ichiro Minato, Atsuo Fukai, Shuichi Takeya, Hitomitsu Kikitsu, Hiroshi Arai, and Tomohiko Sakata; Building Research Institute (19 members): Juntaro Tsuru, Nobuo Furukawa, Masanori Iiba, Shoichi Ando, Wataru Gojo, Hiroshi Fukuyama, Yasuo Okuda, Taiki Saito, Bun-ichiro Shibasaki, Koichi Morita, Hiroto Kato, Tsutomu Hirade, Takashi Hasegawa, Tadashi Ishihara, Norimitsu Ishii, Yushiro Fujii, Haruhiko Suwada, Yasuhiro Araki, and Toshikazu Kabeyasawa

Table 4.1 Damage Statistics in Inundation Areas due to Tsunami *

Prefecture	City, Town, Village	Human Damage			House Damage			
		Dead	Missing	Injury	Complete Destruction or Missing	Partial Damage	Below Partial Damage	Fire
Aomori	Hachinohe	1	1	17	250	769		2
	Hashikami	0	0	0	12	8	1	
	Total	1	1	17	262	777	1	2
Iwate	Hirono	0	0	0	10	16	5	
	Kuji	2	2	8	65	210		
	Noda	38	17	17	309	169		1
	Hudai	0	1	1				
	Tanohata	14	19	8	225	45	4	
	Miyako	420	124	33	3,669	1,006	176	6
	Yamada	597	256	Unknown	2,789	395	120	2
	Otsuchi	796	653	Unknown		3,677		2
	Kamaishi	881	299	Unknown	3,188	535	120	
	Ofunato	331	118	Unknown	3,629		Unknown	2
Rikuzentakata	1,546	569	Unknown	3,159	182	27		
Total	4,625	2,041	67	20,720	2,558	452	13	
Miyagi	Kesen-numa	1,004	410	Unknown	8,533	2,313	3,248	8
	Minamisanriku	550	437	Unknown	3,167	144	Unknown	5
	Onagawa	535	414	2	2,939	337	640	5
	Isinomaki	3,153	890	Unknown	19,065	3,354	10,199	23
	Higashimatsushima	1,044	104	Unknown	4,589	4,672	2,471	1
	Matsushima	2	0	37	213	1,321	1,184	2
	Rifu	1	1	1	59	508	1,732	
	Shiogama	20	1	10	682	2,784	3,973	8
	Shichigahama	66	6	Unknown	729	460	1,067	
	Tagajo	188	3	Unknown	1,662	2,993	5,097	15
	Sendai	704	33	2,276	19,922	41,344	56,347	39
	Natori	911	82	Unknown	2,786	922	8,060	12
	Iwanuma	183	1	293	720	1,545	2,403	1
	Watari	256	5	44	2,459	1,032	1,985	3
Yamamoto	670	23	90	2,200	1,042	1,086	2	
Total	9,287	2,410	2,753	69,725	64,771	99,492	124	
Fukushima	Shinchi	107	3	3	548	Unknown		
	Soma	454	5	71	1,049	643	3,092	
	Minamisoma	633	38	59	4,682	975		
	Namie	141	43					
	Futaba	29	6	1	58	5		
	Okuma	73	1		30			
	Tomioka	19	6					
	Naraha	11	2	5	50			
	Hirono	2	1		Unknown	Unknown		
	Iwaki	308	39	4	6,585	18,931	21,800	3
Total	1,777	144	143	13,002	20,554	24,892	3	
Ibaraki	Kitaibaraki	5	1	188	339	1,569	5,745	3
	Takahagi	1		19	131	728	3,213	
	Hitachi			166	403	3,016	11,229	4
	Tokai	4		5	56	104	3,150	2
	Hitachinaka	2		27	79	720	5,863	1
	Oarai	1		6	10	268	1,087	
	Hokota			15	96	524	4,863	3
	Kajima	1			368	1,726	2,567	4
	Kamisu			6	139	1,660	3,011	3
Total	14	1	432	1,621	10,315	40,728	20	
Chiba	Choshi			19	23	105	1,938	
	Asahi	13	2	12	336	931	2,358	
	Total	13	2	31	359	1,036	4,296	0
Sum Total	15,717	4,599	3,443	105,689	100,011	169,861	162	

* Fire and Disaster Management Agency (FDMA) on August 11, 2011 [4.1]

(2) Overturning

Overturning was observed in 4-story or lower buildings. In all overturned buildings, the maximum inundation depth exceeded their height. Overturning types include building that fell sidelong (Photo 4.2) and buildings that turned upside down. Most of the overturned buildings are of mat foundation. In some overturned buildings on pile foundation, piles were pulled out.



Photo 4.2 Overturning of 3-story Reinforced Concrete Building

An overturning case was often seen in 4-story or lower buildings with relatively small size of openings. However, there were many cases where 4-story or lower buildings with large size of openings were not overturned. Consequently, a size of an opening on an exterior wall is considered to have greatly affected overturning.

In some cases, there were tsunami traces at the heights of the upper end of openings on the top floor inside the buildings whose heights were exceeded by maximum inundation depths. It is considered that air has accumulated in the space between the ceiling and the upper end. Overturning is considered to occur when an overturning moment by tsunami wave force exceeds an overturning strength by a dead load of a building (considering the effect of buoyancy as required). A building, in which a distance from the upper end of an opening on each floor to a ceiling is long, may be overturned even by a slight horizontal tsunami force when buoyancy significantly acts on the building.

(3) Movement and washed away

Most of the overturned buildings were moved from their original positions. It is estimated that large buoyancy acted on the buildings. Moved and overturned buildings left no dragged traces on the ground. One of the buildings climbed over a concrete block fence on an adjoining land (about 2 m) without destroying the fence (Photo 4.3). The building seems to have floated up by buoyancy. Some of the 2-story apartment houses with the same shape that were overturned were washed away and missing. A buoyancy and large horizontal force seem to have acted on these buildings.



Photo 4.3 2-story Reinforced Concrete Building that Climbed over the Fence and Overturned

(4) Tilting by scouring

When tsunami acted on a building, a strong stream was generated around the corner of the building, resulting in many large holes on the ground that were bored by scouring. In one case, a building on mat foundation fell into a hole bored by scouring (Photo 4.4).

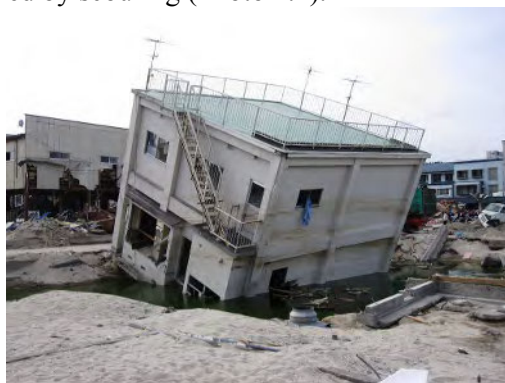

Photo 4.4 2-story Reinforced Concrete Building that was Tilted by Scouring

(5) Fracture of wall (fracture of opening)

When tsunami acts on openings in a building and opposite openings are smaller than the affected openings, a stream flowing from the affected openings concentrate on the opposite small openings. In one observed case related to this event, a stream generated by tsunami provided a large pressure to a reinforced concrete non-structural wall around small opposite openings. The pressure enlarged the concrete wall to the outside and fractured the wall reinforcement. A tsunami wave force that acts on a building will be reduced if the size of opening affected by the force becomes larger. The same trend is considered to apply to an outlet surface of the stream.

A case where such wall reinforcement was fractured is often seen in wall members with single layer bar arrangement. In one damaged building (Photo 4.5), a 300 mm-thick shear wall with double layer bar arrangement and a support span of more than 10 m and without no 2-story floor was bent inside by a tsunami wave pressure. However, a shear wall in an area (Photo 4.5 Back of the building), where there is a floor on the second story and a support span is not long in the same building, was not bent.



Photo 4.5 Out-of-plane Fracture of Reinforced Concrete Shear Wall without Floor

(6) Debris impact

Debris impact was seen in most of the non-structural members such as window and ceiling materials. The number of cases of clear damage to skeletons was not large, but in one observed

case, a multi-story wall in an apartment house was probably bored by debris impact (Photo 4.6).



Photo 4.6 Wall Opening Generated by Debris Impact

4.3.2 Steel buildings

(1) Movement and washed away by fracture of exposed column base

A typical case of building movement and washed away is that a building moved and flew due to the fracture of anchor bolts and/or base plates at steel exposed column bases and the fracture of a weld between the column and the base plate (Photo 4.7). In most cases, a foundation and some column bases were left in a site, but the body of a building was moved beyond the site and missing.



Photo 4.7 Steel Building Overturned by Fracture of Column Base Anchor Bolts

(2) Movement and washed away by fracture of capital connection

In damage cases relatively often seen a column

top connection on the first or second floor in a building was fractured and the building was moved and washed away. When a column base has a large strength like concrete encases type or embedded type, this type of fracture is considered to occur. In one case (Photo 4.8), a foundation in a building, and several columns on the first floor (or up to the second floor) were left on a site, and the columns fell in the same direction (Photo 4.8).

In most cases, welds between diaphragms with lower flanges and the first-floor columns were fractured and the sections of the columns were exposed. In one building, flanges of the second-floor H-shaped beams were torn. Based on the deformation states near the column bases, it is estimated that a tensile force acted on the first-floor columns and fractured the first-floor column top connections after the first floor was greatly tilted to the same extent as the inclination of the remaining columns.



Photo 4.8 First-floor Columns Falling in the Same Direction

(3) Overturning

One case, in which a whole building including foundation is overturned, was confirmed. Most of the ALC panels of claddings were left (Photo 4.9).



Photo 4.9 Overturning of 3-story Steel Building

(4) Collapse

Damage cases of skeleton collapse include story collapse of the first floor in a 2-story steel building (Photo 4.10) and partial collapse of a warehouse on the coast.



Photo 4.10 Story Collapse of First Floor in 2-story Steel Building

(5) Large residual deformation

Slight tilting was often observed in steel buildings with only a skeleton left. In one case (Photo 4.11), a gabled roof frame building did not collapsed despite large residual deformation.



Photo 4.11 Tilted Gabled Roof Frame

(6) Full fracture and washed away of cladding and internal finishing materials

Cladding materials such as ALC panel were almost fully fractured and washed away, and a steel frame as a skeleton was left. This case was often seen (Photo 4.12). It is considered that an external force that acts on the skeleton became small, due to early washed away of the cladding materials. In the remaining building, slight tilting of the skeleton, member deformation on the face affected by tsunami, or members locally damaged possibly by debris impact, was observed.



Photo 4.12 Remaining 3-story Steel Building

In another damage case, openings on the face affected by tsunami and on its opposite face, or transverse faces were greatly damaged and fractured possibly due to stream runoff.

4.3.3 Damage to wood houses

Damage patterns of wood houses that were caused by tsunami are considered to be greatly

related to a maximum inundation depth. In the case of a maximum inundation depth more than about 6 m (equivalent to a height of eaves of 2-story wood house), the number of 1-story and 2-story Wood houses that remained was almost zero. A damage pattern case where a superstructure in a house was washed away with only its foundation and ground sill left (Photo 4.13) or where the superstructure and the ground sill were washed away with only the foundation left was frequently confirmed.



Photo 4.13 Remaining Ground Sill after Washout of Superstructure

In the case of a maximum inundation depth of about 1 m, most of wood houses remained. Some wood houses were damaged possibly due to debris impact. In the case of a maximum inundation depth of about 1 to 6 m, some wood houses remained. Some wood houses behind the relatively stronger building for tsunami wave force such as a reinforced concrete building remained. This is possibly due to that a tsunami wave force was significantly alleviated by the building not washed away (Photo 4.14).



Photo 4.14 Remaining Wood Houses Behind Remaining Building

In addition to these cases, a tsunami wave force was reduced possibly due to many openings in the direction affected by tsunami, or a wooden house remained despite washed away of columns and external walls in the corner of the building. Several houses that have a reinforced concrete piloti on the first floor, or a mixture of wooden and reinforced concrete structures, remained (Photo 4.15).



Photo 4.15 Remaining Mixed Building with Reinforced Concrete Piloti on First Floor

4.4 Database for Investigated Buildings

Outer dimensions of about 100 buildings and dimensions of their skeletons were measured in the site investigation. Maximum inundation depths were measured from tsunami traces on surveyed buildings and surrounding buildings. These measurement results were integrated into a database for investigated buildings. Building name, address, purpose, construction year, designation as tsunami evacuation building, structure category, number of stories, outer dimension, distance from seacoast (river), GPS position, altitude, surrounding circumstances, damage situations, etc., were included in the database. In addition, photos of investigated buildings that were taken from four directions where possible were attached to the database. Based on the database, we estimated strengths of the buildings and tsunami loads on them, and are evaluating whether the estimated values are consistent with the damage situations.

4.5 Discussion on Guidelines for Tsunami Evacuation Buildings by the Cabinet Office of Japan

The Cabinet Office made guidelines for tsunami evacuation buildings in 2005 [4.3]. After the Tohoku earthquake, the committee on structural design for tsunami evacuation buildings (Leader: Prof. Y. Nakano, University of Tokyo) was organized in order to validate the equation of tsunami wave pressure on buildings, using the database for 52 buildings and 44 structures investigated in inundation areas due to the tsunami.

The NILIM announced the results of the validation of the equation of tsunami wave pressure on buildings based on the interim committee report in August, 2011 [4.3]. The general content of the interim result is as follows.

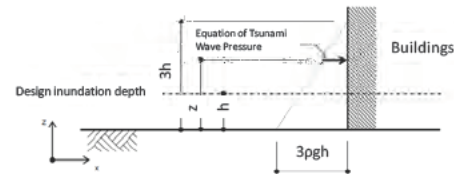

$$\text{Equation of Tsunami Wave Pressure: } q_x = \rho g (3h - z) \quad (1)$$

- q_x : design tsunami wave pressure (kN/m²)
- ρ : density of water (t/m³)
- g : gravitational acceleration (m/s²)
- h : design inundation depth (m)
- z : height from the ground ($0 \leq z \leq 3h$) (m)

Fig. 4.1 Design Inundation Depth and Tsunami Wave Pressure of Guidelines for Tsunami Evacuation Buildings (The Cabinet Office) [4.2]

In the Cabinet Office guidelines, the design tsunami load for the tsunami evacuation buildings was adopted as the tsunami wave pressure eq. (1), hydrostatic pressure of 3 times design inundation depth, based on the maximum envelope of the experimental result in Japan because of the following reasons:

- 1) Simple equation of the design tsunami load
- 2) Safer estimation for the design tsunami load including hydrodynamic effects
- 3) Lack of effective data for the design tsunami load

The strength of reinforced concrete buildings and structures was calculated from the database to be converted into the depth of the hydrostatic

pressure equivalent to the strength of the buildings and structures under the following conditions.

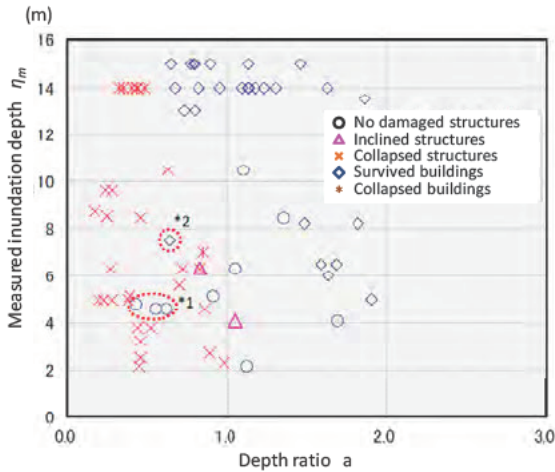

Fig. 4.2 Depth Ratio of Investigated Buildings with Some Obstacles for Tsunami Effect [4.3]

*1: structures paralleled to the tsunami direction
 *2: large openings in side faces of a building

- 1) Mass per unit area for reinforced concrete building structures is 14 (kN/m²).
- 2) Compressive strength of a concrete is 21 (N/mm²) and yielding stress of a round bar is 294 (N/mm²).
- 3) Lateral load carrying capacity of reinforced concrete building structures is roughly estimated with total section area and average ultimate shear stress of columns ($\sigma=1$ N/mm²) and structural walls ($\sigma=3$ N/mm²) according to the Japanese seismic evaluation of existing reinforced concrete building structures.

5. ACTIVITIES ON DEVELOPING COUNTERMEASURES FOR MINIMIZING THE EFFECT OF THE LONG-PERIOD GROUND MOTIONS TO BUILDING STRUCTURES

5.1 Background of the Study

A large scale of fire had broken out to the large oil storage tanks in Tomakomai, Hokkaido after

- 4) Tsunami load is simply reduced in proportion to a ratio of openings to total elevation area affected by tsunami.

A depth ratio α is defined as eq. (2).

$$\alpha = \frac{\eta_s}{\eta_m} \quad (2)$$

α : depth ratio

η_s : depth of the hydrostatic pressure equivalent to the strength of the buildings and structures (m)

η_m : measured inundation depth (m)

Fig. 4.2 plots damage situations of buildings and structures with some obstacles for tsunami effect for α and η_m . A boundary of damage situations of buildings and structures can be considered at the depth ratio $\alpha=1$ except *1 and *2 in Fig. 4.2 when the inundation depth was measured less than about 10m. Many buildings at the depth ratio α much less than 1 remain when the inundation depth was measured more than 10m.

This section classified the damage patterns for different structural categories and briefly discussed the factors that had caused various types of damage. Based on the results of the relevant investigation, we are now conducting an additional field investigation as required and collecting design documents for damaged buildings, while further evaluating the effects of building openings and buoyancy and proceeding with the elucidation of mechanisms for causing damage and the identification of tsunami loads on buildings.

the 2003 Tokachi-Oki earthquake. The long-period motions caused by the large magnitude earthquake and enlarged by the deep sedimentary basin structures under the Tomakomai region amplified and elongated the motions acting to the tanks and the excessive sloshing of the liquid surface occurred and the liquid (oil) overflowed the tanks and the liquid was ignited fire.

After this earthquake, the long-period motions

featured with slow, cyclic and long duration recalled the concerns on the future large earthquakes to occur in the Pacific coast of Japan generating such long-period motions and the excessive responses to long-period building structures such as super high-rise and seismically isolated (SI) buildings.

Meanwhile, large earthquakes such as Nankai, Tonankai and Tokai earthquakes are supposed to occur on subduction zones around Japan in near future. Therefore, we have serious concerns on structural damage due to the long-period ground motions generated by those large earthquakes.

The Central Disaster Management Council, the Cabinet Office, had set up many committees on establishing countermeasures for respective large influential earthquakes. They had also started the study on the effect of the long-period earthquake motions for several subduction-zone earthquakes and estimated the ground motions and subsequent damage for urbanized areas in Japan.[5.1]

The Headquarters for Earthquake Research Promotion (HERP) established in the Ministry of Education, Culture, Sports, Science and Technology (MEXT) after 1995 Kobe earthquake had also started the study on the hazard maps showing the long-period motion estimates that are based on the simulations with possible earthquake source rupture process based on experience during the past large earthquakes and the estimated underground structures. The preliminary maps for the Tonankai, Tokai and Miyagi-Ken-Oki earthquakes were publicized in September, 2009. [5.2] Preparation of the additional long-period motion maps on some other subduction-zone earthquakes are now in progress for publication by the HERP.

The Architectural Institute of Japan (AIJ) had also conducted the extensive study on safety measures for building structures against the long-period earthquake motions. [5.3]

Under these various study activities including those currently in progress as background, the MLIT and the NILIM initiated the funding [1.4] to maintain and promote the enhancement of the

building codes and one of them was the development of the design long-period earthquake motions. Under this funding, the selected working team and the BRI have been doing the cooperative study on the long-period motions. Various kinds of assistance were given from experts on strong ground motion and structural engineers.

The cooperative study had continued from fiscal years 2008 to 2010 and a research report was published by the BRI as product of the studies.[5.4]

Based on the study, the NILIM prepared a tentative new proposal of some methodology to evaluate the long-period motions for new and existing high-rise buildings in December 2010 and invited the public comments from the MLIT (Tentative New Proposal by MLIT and NILIM).

These are the recent progress on the evaluation of long-period motions. Here, we would like to briefly show the project for developing the countermeasures for minimizing the effect of the long-period motions that MLIT and NILIM proposed.

5.2 Brief History of Design Earthquake Motions for Super High-rise Buildings in Japan

In Japan, the construction of high-rise buildings over 60 meters (hereafter, referred to as HR building) started in the late 60's. The recorded motions available for design at the time were very few both in number and quality. Therefore, an amplitude-magnified recorded motions were mainly used as well as the well-known records such as El Centro NS component from 1940 Imperial Valley earthquake or Taft EW component from 1952 Kern County earthquake that were already in use. The maximum amplitude levels used for magnification were 200-300 cm/s^2 for elastic design, and 300-500 cm/s^2 for elastic-plastic design. Afterwards, the scaling with maximum velocity amplitude level was replaced as appropriate for relatively longer-period dominant ground motions. The scaling with maximum velocity amplitude with 25 cm/s for damage-protection design and 50 cm/s

for collapse-protection was established in mid 80's. [5.5] The scaling scheme is still maintained for parts of the design motions. In mid-90's, a project left a fruit that proposed a design motions for the HR buildings. The project was conducted as a cooperative research work between the Building Center (BCJ) of Japan and the BRI of

Japan. In the proposal, the design motion was defined at the outcropped hard soil surface that was referred to as 'Engineering Bedrock'. This motion is named as BCJ-wave. The pseudo velocity response spectrum is shown in Fig. 5.1. [5.6]

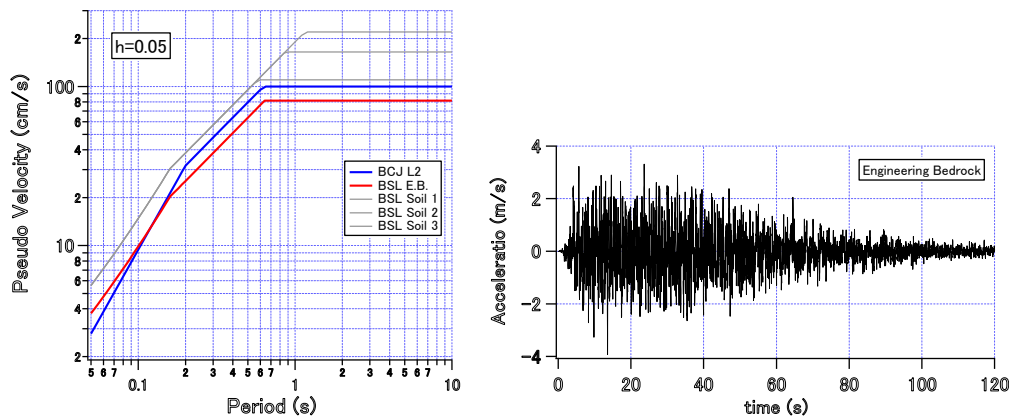

Fig. 5.1 BCJ (L2) and Building Standard Law Design Spectra and Building Standard Law Wave for Engineering Bedrock

The Building Standard Law of Japan was partly revised in 2000, consequently, the design spectrum for response history analysis was officially added as one of its notifications. The design spectrum was derived corresponding to the conventional design seismic force and was lower than the previously shown BCJ-wave spectrum as also shown in Fig. 5.1. In Fig. 5.1, an example of notification-spectrum compatible waveform is shown. The notification also requests site-specific motions referred to as 'site-wave' considering the earthquake environment of the construction site such as nearby influential active fault, etc. (CAO, 2008 [5.1], AIJ, 2007 [5.2], etc.)

The problems are summarized as follows;

- (1) The longer-natural period buildings such as high-rise and seismically isolated buildings that have been thought as advantageous to strong earthquake motions turned to be vulnerable to long-period motions.
- (2) The long duration time is important for buildings with low-damping and/or equipped with cumulative energy dissipation devices.
- (3) Many such buildings have been built on large

cities in Japan. Most of those are located on large deep sedimentary basins.

- (4) Recorded long-period motions are still insufficient including building responses although the nationwide seismometer networks have been established after the 1995 Kobe earthquake.
- (5) Urgently needed is the evaluation methodology of ground motions with large earthquakes expected to occur in near future for confirming the safety of many existing and new structures.

5.3 New Methodology for Design Long-period Ground Motions

The research on the evaluation of long-period motions has widely been conducted using theoretical method such as the 3D-FDM. On the other hand, the researches with the empirical evaluation of the long-period motions are very few to date. Kataoka (2008) [5.7] showed the attenuation formula for evaluating the response spectral properties. However, almost no research work has targeted on the time history generation.

Considering the usefulness of the formula and expecting the data accumulation in future, the empirical method will become much more useful in engineering sense. In addition, the evaluated motion with the empirical method will be useful enough to judge the plausibility of the theoretical method.

Here, we used nationwide many ground motion records to make an empirical model to predict the ground motion with 0.1 to 10 second period range. Furthermore, based on this formula, we investigated the method to construct the long-period ground motion time histories generated by hypothetical large future earthquakes. [5.8].

5.3.1 Attenuation formula for acceleration response spectra with 5% damping in longer period

The data used here are selected from JMA87, JMA95, K-NET, and KiK-net, etc.

The selecting criteria of records are as follows,

- 1) Subduction Type : $M_j > 6.5$ for hypocentral distance $< 400\text{km}$ (M_j : JMA magnitude)
- 2) Crustal Type: $M_j > 6.0$ for hypocentral distance $< 350\text{km}$
- 3) Hypocentral depth $< 60\text{km}$

The location of earthquake epicenters and their magnitudes are shown in Fig. 5.2. It is seen that the subduction type earthquakes are mainly on the Pacific Ocean side.

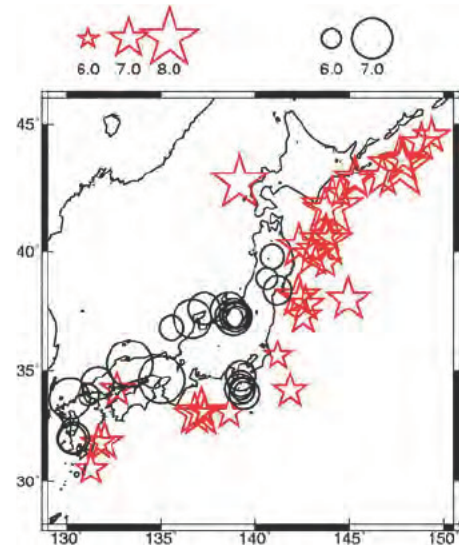

Fig. 5.2 Location of Earthquake Epicenters Used

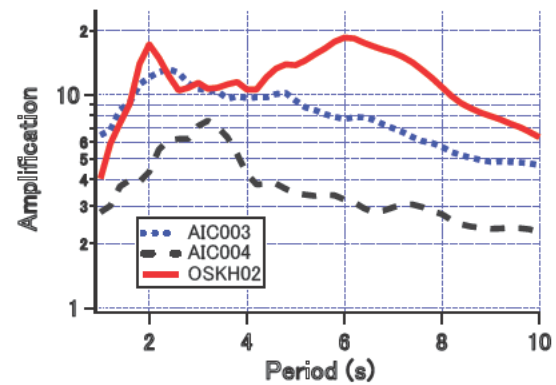

Fig. 5.3 Amplification Factors $c_j(T)$ of OSKH02 in Osaka, AIC003 and AIC004 in Aichi

In the least square analysis, the 5% damping acc. response spectra is related with the moment magnitude and the shortest distance from recording station to the assumed source area of each recorded event, i.e.,

$$\log_{10} S_a(T) = a(T)M_w + b(T)R - \log_{10}(R^{p(T)} + d(T)10^{0.5M_w}) + c(T) + c_j(T)$$

where, M_w is the moment magnitude and R is the shortest distance in kilometer from the recording site to the source area, and $a(T)$, $b(T)$, $d(T)$, $p(T)$, $c(T)$, $c_j(T)$ are coefficients to be determined with the least squares analysis. The coefficient $c(T)$ is assumed to be the site amplification factor for KiK-net FKSH19 station which is regarded as

benchmark station on the seismic bedrock and $c_j(T)$ is a site amplification factor for the j -th recording station. The least square analysis was conducted separately for subduction and crustal earthquake type datasets. However, the final $c_j(T)$ was taken as a weighted average of $c_j(T)$ coefficients for both cases with data number taken as weight. Therefore, the $c_j(T)$ is treated as identical for subduction and crustal earthquakes. Fig. 5.3 shows the site amplification factors for three sites, OSKH02, AIC003, and AIC004. It is seen that the site amplification factor that shows the amplification from seismic bedrock to

surface becomes nearly 20 at around 6 second for OSKH02 site, located at the coast of the Osaka Bay. The sites AIC003 and AIC004 are both in the Aichi Prefecture, but it is seen that the site amplification factors are different within the Nobi plain. In addition, the site amplification map for whole Japan area is also shown in Fig. 5.4. It is seen that the factor takes large value for area such as Kanto, Osaka, Nobi, Niigata, Sakata, Ishikari-Yufutsu, and Tokachi plains that holds thick overlying soil medium.

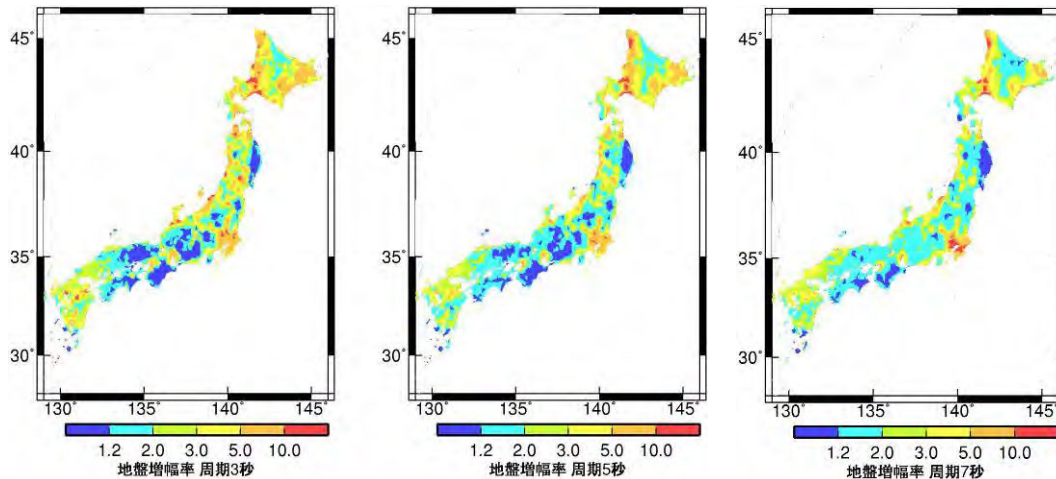

Fig. 5.4 Nationwide Distribution of Amplification Factors $c_j(T)$ with Periods of 3, 5, and 7 Second

5.3.2 Empirical formula for frequency-dependent average and variance of narrow-band group delay time

The average value μ_{igr} of the group delay time corresponds to the gravity center of arriving time of wave group in a narrowband. The standard deviation σ_{igr} of the group delay time corresponds to the scatter of the arriving time that is the duration time of the wave group in the narrowband. [5.9] Since the group delay time is the first derivative of the Fourier phase spectra, once the initial phase angle is fixed, the other phase angles are calculated recursively, assuming a normal distribution with the average and standard deviation values within the narrowband. The method holds an advantage to realize the

spectral non-stationarity of the wave seemingly caused by the dispersion of surface waves. The average values are corrected so that the rupture initiation time should be zero.

Since both of the average group delay time μ_{igr} , and the standard deviation σ_{igr} of group delay time can be related with the source property, path effect and the site characteristic, both μ_{igr} and σ_{igr}^2 were eventually related in the following relationship.

$$Y(f) = A(f)M_0^{1/3} + B(f)X + C_j(f)$$

where, $Y(f)$ is either μ_{igr} or σ_{igr}^2 , M_0 is seismic moment in dyne-cm, X is the hypo-central distance in kilometer, the 'f' is frequency in Hz. $A(f)$, $B(f)$ and $C_j(f)$ are determined by the least square analysis. The site coefficient for μ_{igr} and

σ_{igr}^2 with horizontal component for OSKH02, AIC003, AIC004 sites are shown in Fig. 5.5. It is seen from the figure, both site coefficients become larger for longer period.

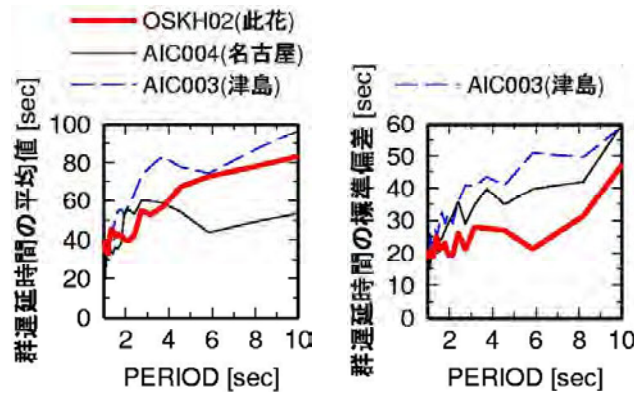

Fig. 5.5 Site Coefficient with Average (left) and Standard Deviation (right) of Group Delay Time

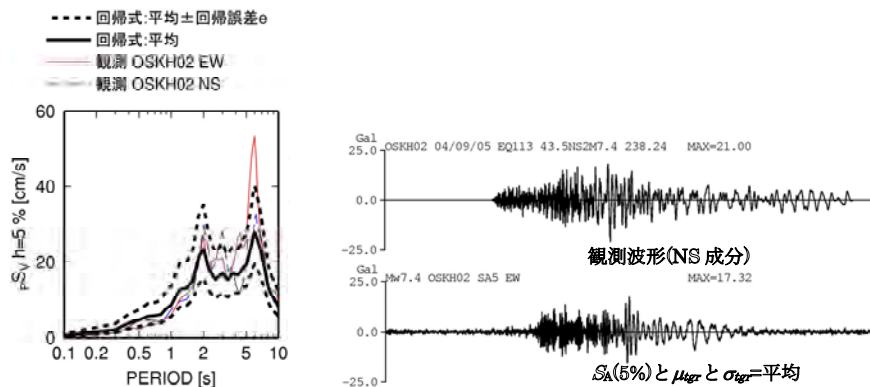

Fig. 5.6. Comparison of pSv and Waveform between Recorded and Simulated Motions for OSKH02

5.3.3 Generation of waves with empirical formula

For generation of the time history, the Fourier phase angles are firstly determined using the regression formula with μ_{igr} and σ_{igr} and giving initial phase angles and random numbers with normal distribution of μ_{igr} and σ_{igr} . Then, the 5% damping acc. response spectrum are determined with the attenuation formula. The Fourier amplitudes will be corrected so that the generated wave holds the acc. Response spectrum by correcting the Fourier amplitudes cyclically. [5.10]

At first, the method was examined with its validity by simulating the recorded motions during the 2004 Off-Kii-Peninsula earthquake (Mw=7.4). Fig. 5.6 shows the comparison of response spectra and waveform between recorded and generated waves for the 2004 earthquake for the OSKH02 site. The duration time of generated velocity waveform is less than the recorded, when the average values with the group delay time standard deviation is used. These comparison shows the method can reproduce the recorded motion when a regression error is taken into account appropriately.

We generated the waves for Nankai (Mw=8.5)

earthquake with site OSKH02, and for Tokai-Tonankai (Mw=8.3) earthquake with sites AIC003 and AIC004 sites. The macroscopic fault plain modeled as a rectangle for Nankai earthquake [5.11] and the rupture initiation points and the location of the predicting site are indicated in Fig. 5.7(a). In Fig. 5.7(b), the rectangular fault plain model for Tokai-Tonankai earthquake based on Sato, et. al. (2006) [5.12] etc. are shown. When the multiple plain fault model is assumed, each generated wave from single component fault model will be added considering rupture time differences to get the final total waveform.

The pseudo response spectra for the Nankai earthquake using the method was shown in Fig. 5.8, and compared with the preceding simulations by Kamae (2006) [5.13], Tsurugi (2005) and Sekiguchi (2006) [5.14]. Kamae's result includes components longer than 2.5 second. Other simulations include short period components. The generated velocity waveforms are also shown in Fig. 5.9.

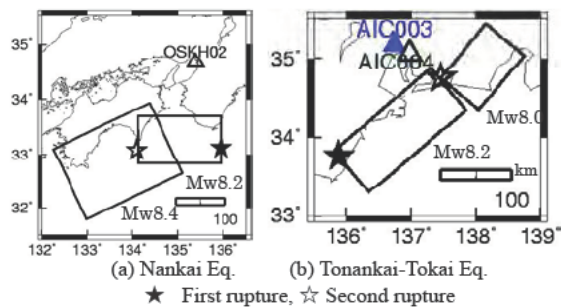

Fig. 5.7 Source Models used for Nankai and Tonankai-Tokai Earthquakes (Tsurugi, 2005, Sato, 2006)

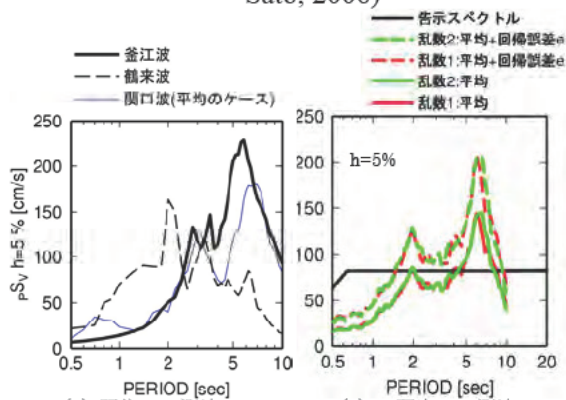

Fig. 5.8 Comparison of pSv with Other Research Results (left) and This Study (right)

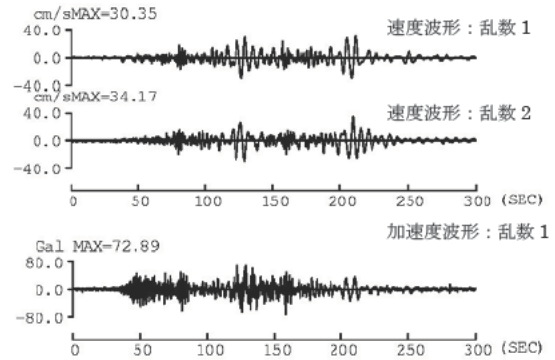

Fig. 5.9. Velocity (two random number cases) and Acceleration Waveforms with OSKH02 Site for Hypothetical Nankai Earthquake

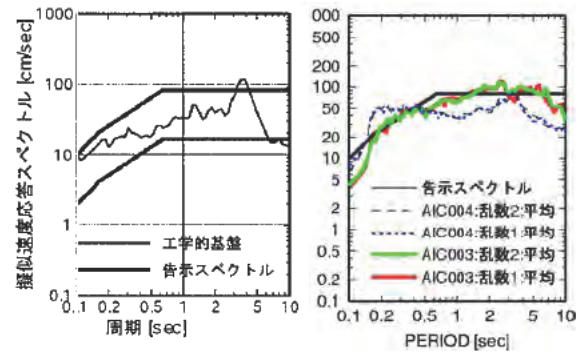

Fig. 5.10 Comparison of pSv's for Tonankai-Tokai Earthquake between Previous Study (left) with NST site at downtown Nagoya and this study (right) with AIC003 and AIC004 sites

In addition, the pseudo velocity response spectra for AIC003 and AIC004 for Tonankai-Tokai earthquake were compared in Fig. 5.10 with the simulated wave for NST site, located at downtown Nagoya that was estimated with so-called hybrid procedure. It is seen that the spectral levels at longer period for AIC004 and NST are comparable. In Fig. 5.11, the predicted waveforms for both sites are also compared. The maximum velocity amplitudes and the effective duration times for both waves are almost equivalent.

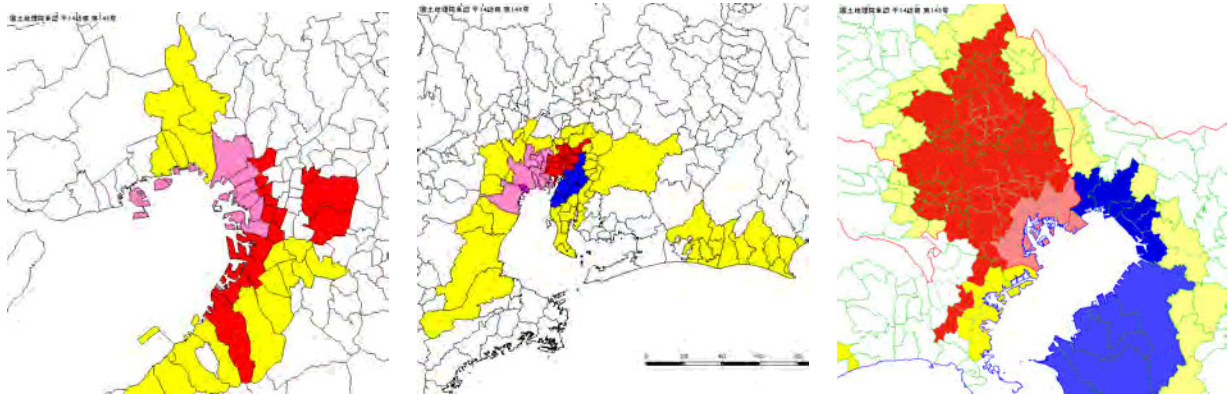

Fig.5.11 Selected areas from Tokyo, Aichi and Osaka and those area was divided into 9 sub-divided areas. Each sub-area is given design spectrum and corresponding time history to represent the sub-area.

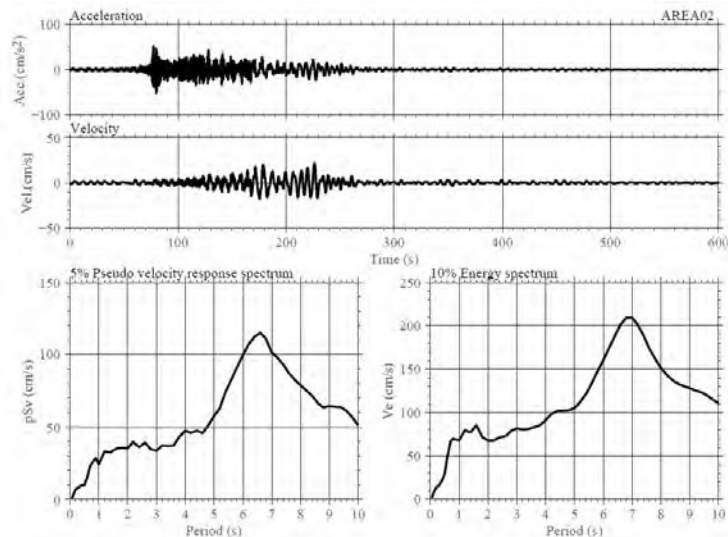

Fig.5.12 Assigned long-period motion for area No.2 in Tokyo corresponding to the pink area for the rightmost map in Fig. 5.11. The acceleration and velocity waveforms are given above. The 5% damping pseudo response spectrum and the 10% damping energy spectrum are given in the lower figure.

5.4 Tentative New Proposal for Countermeasures on Long-period Earthquake Motions by MLIT and NILIM

Based on the studies introduced in the preceding sections, the MLIT and the NILIM have made a so-called tentative new proposal on the countermeasures of seismic safety for high-rise buildings in December, 2010. This section briefly describes about it.

As explained in 5.2, the design earthquake motions for high-rise buildings in Japan have been changing to date. Therefore, the design

motions for HRs in early days do not necessarily meet the standards of today, since there were not the concept of the design long-period motion at that time. Therefore, these buildings need to be verified their safety with the newly evaluated design motions.

5.4.1 Earthquakes, evaluation of long-period motions, and zonings

The Tonankai, the Tokai and the Miyagi-Ken-Oki earthquakes were selected for the evaluation of the long-period motions. The earthquake magnitudes and epicenters for these three

earthquakes were based on the HERP's specification, with which they also made long-period motion maps.

The highly urbanized area in Tokyo, Aichi, and Osaka was selected and made 9 zonings were made that represent the surrounding area in view of the long-period motions as shown in Fig.5.11. The Tokyo Metropolitan area has 4 zonings that represent Tokyo Bay, Tokyo uptown, Yokohama and Chiba sub-areas. The Aichi area was represented by three zonings, the western, the central and the eastern sub-areas. Finally, the Osaka area was represented by two zonings, both facing on the Osaka Bay also shown in Fig. 5.11. Depending on the sub-area that each of the construction sites belongs, a long-period motion is assigned for the safety check. For example, area-2 in Tokyo (red area) is given the motion given in Fig. 5.12.

The 9 zonings are made specifically for the three earthquakes.

For earthquakes other than these, the proposal includes how to generate the long-period motions for the specific site.

5.4.2 Application of the tentative new proposals by the MLIT and the NILIM

For new high-rise buildings, re-evaluation of earthquake safety is requested using the assigned long-period motion from aforementioned three large earthquakes.

Some consideration is requested for protecting the furniture and utensils, such as copy machines from overturning.

Some technical information for the promotion with affordable design consideration will be provided, for excess long-period motions with multiple earthquake source events as well as the motions from single event mentioned above,

For existing high-rise or seismically isolated buildings that already acquired the minister's approval, the assigned motion is compared with the actually used design motions and if the

assigned one even partly exceeds the used one, the building is requested for re-evaluation of the seismic safety with the newly assigned long-period motions and for strengthening if necessary.

5.4.3 The MLIT/NILIM proposals and re-start of the study

The MLIT/NILIM proposal immediately invited the public comments on December 21st until the end of February, 2011. Many comments were collected. The brief summary of the comments are disclosed by the MLIT. It says,

1. Agrees with the MLIT/NILIM actions for the long-period ground motions
2. Some other earthquakes that control the area such as the Nankai earthquake should be considered.
3. Some alleviated countermeasure or financial assistance will be recommended, because the retroactive application is too strict.
4. The design criteria in building performance should be presented as well as the input motions.

It is taken into consideration that these are summarized comments collected before the Tohoku earthquake occurred.

In addition, huge number of strong motion records is obtained by many public and private earthquake observation networks. Some verification study will be crucial using these data to enhance the reliability of the methodology that can account for the recorded data.

5.5 Conclusions

In this paper, a method was proposed that would produce broadband long-period (0.1-10 sec.) earthquake motion waveforms using earthquake parameters, such as, the seismic moment, the macroscopic fault plain model, rupture initiation position, time difference among ruptures for multiple events.

It was suggested that the empirical formula for long-period earthquake motions even in spectral property was very few, however, the method presented here will be useful in case of

generating earthquake motion time history.

The simulated waves using the proposed method was in general comparable to the results in the preceding research results, although the number of the long-period earthquake records are in general very small and the situation makes the statistical study using those data unreliable and also that there are some cases in which the recording time is not sufficient for the purpose.

In view of that these research results will be applied to the specific field, seismic design of buildings, it is necessary to make further studies

6. COPING ACTIVITIES BY NILIM AND BRI

From the Tohoku earthquake, the following issues are obtained to be countermeasured administratively for example by modifying current building technical standards.

- (1) Evaluation of load effect by tsunami
- (2) Countermeasure for falling down of non-structural elements, especially of ceilings
- (3) Long-period earthquake ground motion countermeasure for buildings with long natural periods
- (4) Liquefaction countermeasure for residential land of detached housings

In addition to above issues, cracks in the damping devices (lead damper) of the seismically isolated buildings were observed under a number of reversed cycles of loadings with small displacement amplitude even at places of rather small ground motions, with no severe damage in building structures. Lead rubber bearing which is made of rubber layers and stiffening plates with lead plug inserted is thought to be investigated like cracked exposed lead damper. The Japan Society of Seismic Isolation has started the survey and investigation on this issue on the request by MLIT and NILIM utilizing the grant-in-aid mentioned later, thus the progress of the study should be carefully observed.

in parallel on the earthquake responses of the HR buildings and/or the base-isolated buildings to these simulated motions and their uncertainties.

In addition, the MLIT/NILIM tentative new proposal for the countermeasures for the long-period ground motions was introduced. The proposal will be upgraded using the new data from the Tohoku earthquake.

The Building Structural Code Committee⁵ chaired by Tetsuo Kubo, University of Tokyo, established in NILIM will investigate these issues as shown in Fig. 6.1. Where, MLIT and NILIM identify study items and invite those (“execution team”) who serve as volunteer for the work on study items by utilizing the grant-in-aid [1.4] for maintenance and promotion of building codes. BRI is appointed to work together with the execution team.

⁵ Draft of the building structural codes prepared by NILIM will be reviewed from the technical point of view by the Building Structural Code Committee. The modified draft by NILIM based on the review will be sent and will be put into Enforcement order or Notification by MLIT.

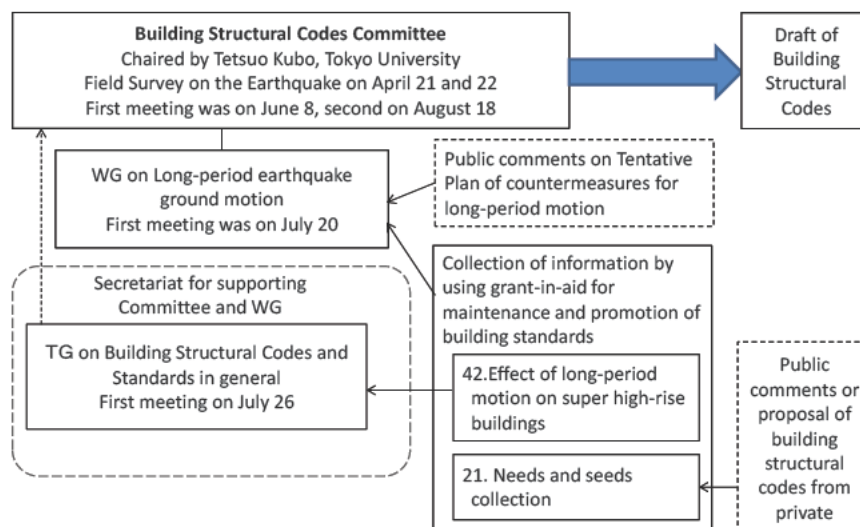

Fig.6.1 Building Structural Codes Committee

(1) Outline of evaluation of load effect by tsunami

Miyagi Prefecture and Ishinomaki City assigned building restrictions in the damaged urban area based on the Article 84 of the Building Standard Law⁶. This assignment is active for 8 months at the maximum by the Special Law which came into force after the Tohoku earthquake. At the time of reconstruction of these areas, it is surely requested to reconstruct safe urban area even for another tsunami. Therefore, the technical information on the load effect by tsunami, which can be used in designing new buildings, is urgently in need.

Investigation on the building structural codes in the area of tsunami danger was started after the earthquake by the execution team of the Institute of Industrial Science, Tokyo University lead by Yoshiaki Nakano. The study items are 1) verification of structural design method for tsunami evacuation building, and 2) building restrictions, which should be, in the area of tsunami danger. In this section, 1) will be explained briefly.

In the existing guidelines [1.3] on the structural design method for tsunami evacuation buildings, as shown in Fig. 4.2, the tsunami load is estimated as the hydrostatic pressure acting on

one side of the building whose inundation depth is 3 times the design tsunami inundation depth. Here, the value of 3 was determined from the laboratory test utilizing waterway, which was validated later by the field survey of tsunami damage by the 2004 Indian Ocean Tsunami Disaster [6.1]. However, the inundation depth of this time tsunami reaches about 15m or more which is far above the previous study and the topographical shape of rias coastline has not yet been verified. According to the interim report by the execution team, 44 examples of simple structures and 52 examples of buildings which subjected tsunami damage were collected and used for verification of the value. Fig. 6.2 shows the comparison of the measured tsunami inundation depth and the estimated value for simple structures and buildings with and/or without tide embankment etc. As seen from the figure, the value of 3 seems to be reduced drastically in case of with tide embankment, and the value becomes less than 1 in case of higher tsunami inundation depth such as over 10m. It is explained in the interim report that the load

⁶ (Building Restrictions in Afflicted Urban Areas) Article 84. In case of a disaster in an urban area, the special administrative agency may, if it deems it necessary for the city planning or the land readjustment work under the Land Readjustment Law, designate areas and restrict or prohibit the construction of buildings therein, for a limited period of time within one month from the day of the occurrence of the disaster.

effect by tsunami is the largest not at the highest inundation depth, so the effective tsunami inundation depth can be reduced in case of high depth.

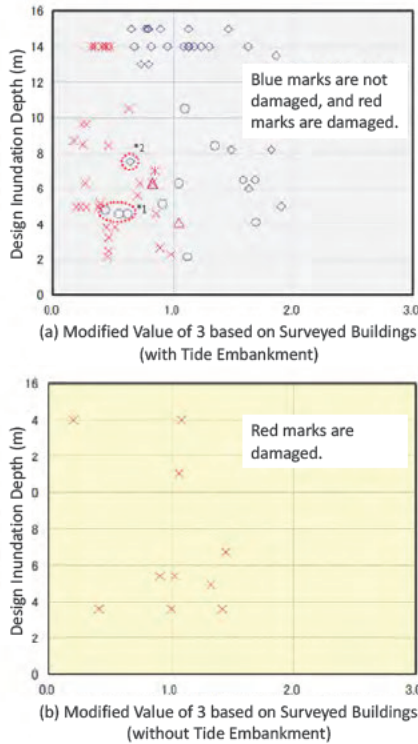

Fig.6.2 Comparison of the Measured Tsunami Inundation Depth and the Estimated Value

In the latter half of this fiscal year, study on the buoyant force and the pile resistance through the study on the overturned buildings, study on the effect of the openings of the buildings on tsunami force, and study on the impact force by the debris to the buildings will be carried out in detail. The report will be planned to be summarized by March, 2012.

(2) Outline of countermeasure for falling down of non-structural elements, especially of ceilings

After the 2001 Geiyo earthquake, in which many ceilings fell down in the large space gymnasiums stood in the urban park, the technical advice to keep appropriate clearance between ceiling and surrounding structure and to install braces on hanging bolts was send from MLIT to the special administrative agency⁷. An additional technical advice to keep clearance even between different

stiffness ceilings was send after the 2003 Tokachi-Oki earthquake, and an appropriate strengthening of clip members which connect ceilings to hanging bolts was indicated after the 2005 Miyagi earthquake. Fig. 6.3 shows schematically these technical advices. In the figure, red circle portions should be taken care in the design of ceilings. From the fiscal year of 2008, vibration measurement, time history analysis, and vibration test using shaker on gymnasiums were performed in order to prepare concrete design manuals for ceilings against falling down.

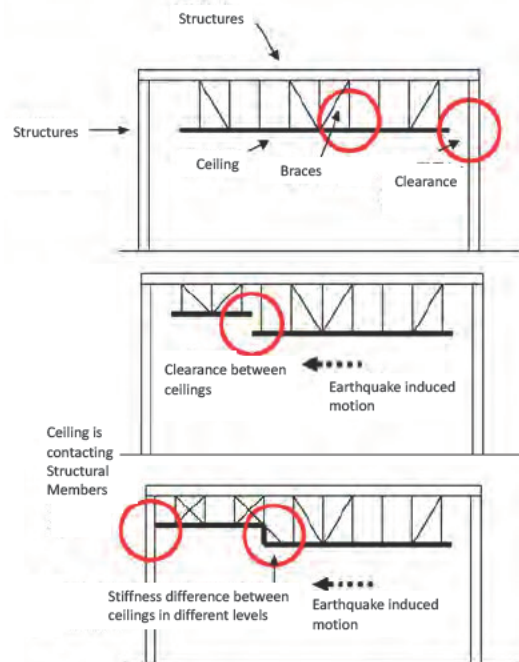

Fig.6.3 Schematic Explanation of Technical Advice on Details of Ceilings

In the Tohoku earthquake, building collapse was rarely observed but many ceilings falling down was reported at the places with not large earthquake motions and even death due to falling down of ceilings was occurred for example in the Imperial Crown Style building in Chiyoda Ward, Tokyo.

Therefore, in order to extensively study the ceiling falling down including effectiveness study on the existing technical advices, the

⁷ The head of a city, town, or village for the area of a city, town, or village having building officials, or the prefectural governor for the area of other cities, towns, or village.

investigation on establishing building structural codes for non-structural elements based on the earthquake damage was initiated by the execution team of Building Performance Standardization Association. The study items are 1) collection and classification of ceiling damages in the Tohoku earthquake, and 2) building structural codes, which should be, for non-structural elements especially for ceilings. In the interim report, 151 examples of ceilings falling down are collected through the questionnaire to the special administrative agency and field survey was made on the selected 10 examples. Fig. 6.4 summarizes the shape of the damaged ceilings in these buildings.

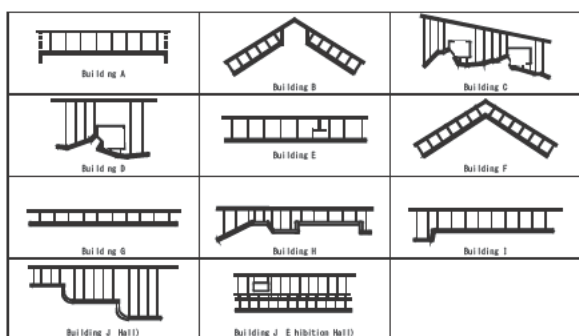

Fig.6.4 Patterns of Ceilings Surveyed

During the next six months after the interim report, concrete countermeasure methods for existing ceilings and safety calculation methods for new ceilings will be considered.

(3) Outline of long-period earthquake ground motion countermeasure for buildings with long natural periods

Prediction map of long-period earthquake ground motions in 2009 (draft) was announced from the HERP, MEXT, in which earthquake motions for expected Tokai earthquake, Tonankai earthquake, and Miyagi-Ken-Oki earthquake are predicted, which raised a social concern on the long-period earthquake ground motions caused by mega-earthquakes at the subduction zone near trench.

The MLIT and the NILIM has been working for the practical solutions for prediction of long-period earthquake ground motions based on observation [5.4] with the assistance by BRI,

because the motions predicted by HERP just include the component of motions with 3.5 seconds or longer and so the higher mode of response of the buildings cannot be represented. The result was announced as the tentative new proposal [1.1] and public comments were collected. Many comments say that Nankai and combined Tonankai-Nankai earthquakes should also be included in the scope of the tentative new proposal as they affect more on the buildings in Nagoya and Osaka Areas than those in the current scope.

Meanwhile, the Tohoku earthquake is much larger than the prediction by HERP and good quality strong motion observations became available. Therefore, the investigation of the effect of long-period earthquake ground motions on the buildings with long natural periods is started by the execution team of Osaka Laboratory, Shimizu Cooperation.

The study items are 1) validation of prediction method (tentative new proposal) utilizing new observation data for long-period earthquake ground motions, 2) preparation of long-period earthquake ground motions at principal places for Nankai and combined Tonankai-Nankai earthquakes, and 3) earthquake response calculation of super high-rise buildings by the prepared motions. In this section, the outline of the validation study in 1) will be explained briefly.

As the Tohoku earthquake occurred in the northeastern part of Japan and the amplifying accretionary wedge⁸ is not on the propagation path, the amplification of long-period component in Tokyo Metropolitan area is expected to be a bit small, which agreed with the observation results. Many good quality observed ground motions at various places can be used to verify the proposed site coefficient in the tentative new proposal for long-period earthquake ground motion prediction based on observation data. The response observations of super high-rise buildings in Tokyo, Nagoya and Osaka, can also be used for validation study. HERP is planning to

⁸ Thick sediment along Nankai Trough is thought to amplify the long-period component of ground motion.

develop source model even for combined earthquakes by the next spring, which can be made use of brushing up the tentative new proposal.

(4) Outline of liquefaction countermeasure for residential land of detached housings

Structural calculation is released for wood houses in the Building Standard Law. Thus, the liquefaction countermeasures cannot be considered in the building construction for the detached housings. In fact, it was thought the liquefaction countermeasure is the issue of the land development and not of the housing construction.

To answer for the social demand in the consumer protection on liquefaction of residential land, a study is planned on the application of the system of performance indication⁹ of detached housings.

It is the investigation on indicator of liquefaction information for detached housings, and the study items are 1) study on the validation of existing liquefaction prediction methods and countermeasuring construction methods, 2) study on the information indicator for liquefaction, and 3) knowledge and information collection on liquefaction prediction and countermeasure methods in the previous investigation and technology development. The execution team is now under the selection as of August 19, 2011.

The liquefaction phenomenon is a big issue not only for detached housings but also for civil infrastructures related to sewerage, river, road, and harbor. In MLIT, technical examination council [6.2] on liquefaction countermeasures was established and the technical information in each field is continuously exchanged. Urayasu where subject to devastating liquefaction damage established technical examination and investigation council [6.3] on liquefaction countermeasures, and Tokyo Metropolitan also established similar council [6.4]. Each council has just started its study, but it is expected that the technical knowledge obtained in each council be unified into common goal. Here, it should be noted that the Swedish weight sounding test method may be the available foundation

investigation tool considering the cost in the field of residential land, thus the technical information in the civil infrastructure field need some translation as the investigation tool is generally in different.

7. CONCLUSIONS

This paper presents outlines of the strong motion observations recorded by the BRI strong motion observation network etc. at in and out of the buildings of various structural types, and of the motion induced and tsunami induced building damage field-surveyed by NILIM and BRI in the occasion of the 2011 off the Pacific coast of Tohoku earthquake (the Great East Japan Earthquake). “Tsunami”, “non-structural elements”, “long-period earthquake ground motion”, and “liquefaction” are identified as important administrative issues to be urgently countermeasured in the building structural codes, and lastly the outline of on-going coping activities on these issues by NILIM and BRI collaborated with the administration is introduced.

8. ACKNOWLEDGMENTS

We would express deepest condolence to the victims of the earthquake and tsunami and their family members as well as those who are affected. We also would like to give hearty thanks for the outpouring of support and solidarity given by all parts of the world to the Japanese people.

9. REFERENCES

- [1.1] MLIT and NILIM: Tentative new proposal for countermeasure against long-period earthquake ground motion of super high-rise buildings and seismically isolated buildings, Dec. 21, 2010. http://www.mlit.go.jp/report/press/house05_hh_000218.html (in Japanese)

⁹ Grading system for houses newly constructed or existing one which is lead on the occasion of the enforcement of the Housing Quality Assurance Act.

- [1.2] NILIM, BRI: Quick Report of the Field Survey and Research on “The 2011 off the Pacific coast of Tohoku Earthquake” (the Great East Japan Earthquake), May 2011. <http://www.kenken.go.jp/japanese/contents/topics/20110311/0311quickreport.html> (in Japanese)
- [1.3] Cabinet Office: Guidelines for tsunami evacuation building, June 2006. http://www.bousai.go.jp/oshirase/h17/tsunami_hinan.html (in Japanese)
- [1.4] MLIT, NILIM: Grant-in-aid for maintenance and promotion of building codes. http://www.mlit.go.jp/jutakukentiku/house/jutakukentiku_house_fr_000037.html (in Japanese)
- [1.5] U.S. Geological Survey (USGS): Historic World Earthquakes, Earthquake Hazards Program. <http://earthquake.usgs.gov/earthquakes/world/historical.php>
- [1.6] National Research Institute for Earth Science and Disaster Prevention K-NET, <http://www.k-net.bosai.go.jp/>
- [1.7] National Police Agency: Damage situation and police action on the 2011 off the Pacific coast of Tohoku earthquake, August 18, 2011. <http://www.npa.go.jp/archive/keibi/biki/higa/ijokyo.pdf> (in Japanese)
- [1.8] Press Release by Urban Bureau of MLIT: Damage Condition by the Great East Japan Earthquake, August 4, 2011. <http://www.mlit.go.jp/common/000162533.pdf> (in Japanese)
- [2.1] Yoshida, Y., H. Ueno, D. Muto, and S. Aoki, Source process of the 2011 Off the Pacific Coast of Tohoku earthquake with the combination of teleseismic and strong motion data, *Earth Planets, and Space*, **58**, pp.1-5, 2011
- [2.2] BRI Strong Motion Network Website: <http://smo.kenken.go.jp/>
- [2.3] T. Kashima and Y. Kitagawa: Dynamic Characteristics of Buildings Estimated from Strong Motion Records, Proceedings of the 8th U.S. National Conference on Earthquake Engineering, Paper No. 1136, December 2005
- [3.1] Masato MOTOSAKA : The 2011 Off The Pacific Coast of Tohoku Earthquake - Quick Report of The Damage Survey - <http://japonism.org/wp-content/uploads/2011/04/motosaka-report.pdf>
- [3.2] Naohito KAWAI : Quick Report of Damage Survey on Buildings Due to The 2011 Off The Pacific Coast of Tohoku Earthquake by Kogakuin University Survey Team for Wood Buildings, Quick Report of Damage Summary Survey in Osaki city and Ichinoseki City on April 11. (An article on the way), non-publication document.
- [3.3] The Japan Building Disaster Prevention Association: Standard for Seismic Evaluation of Existing Reinforced Concrete Buildings, 2001 (English Version in 2005)
- [3.4] National Institute for Land and Infrastructure Management, Ministry of Land, Infrastructure and Transport, Japan and Building Research Institute, Independent Administrative Institution, Japan: Damage Investigation of Buildings due to the Mid Niigata Prefecture Earthquake, pp.305-353, October, 2006 (in Japanese)
- [3.5] Takashi Hasegawa, Akiyoshi Mukai, Kazuo Nishida and Tadashi Ishihara: Damage Investigation of Steel Gymnasiums Due to the Niigataken-chuetsu Earthquake (Part1 Study on structural damage), Summaries of Technical Papers of Annual Meeting, AIJ, B-2, pp.569-570, September, 2005 (in Japanese)
- [3.6] Kazuo Nishida, Akiyoshi Mukai, Takashi Hasegawa and Tadashi Ishihara: Damage Investigation of Steel Gymnasiums Due to the Niigataken-chuetsu Earthquake (Part2 Study on nonstructural damage), Summaries of Technical Papers of Annual Meeting, AIJ, B-2, pp.571-572, September, 2005 (in Japanese)
- [3.7] The Japan Building Disaster Prevention Association: Damage evaluation standard and repair technology guidelines of earthquake damaged buildings, August, 2002 (in Japanese)
- [4.1] Fire and Disaster Management Agency: Damage statistics of the Great East Japan Earthquake on March 11, 2011.8.11 (in Japanese).
- [4.2] The Cabinet Office: Guidelines for Tsunami Evacuation Buildings, 2005.6 (in Japanese)
- [4.3] NILIM : Announcement of the Selection of the Interim Report on “Investigation on the building structural codes in the area of

- tsunami danger” by Institute of Industrial Science, Tokyo University, July 2011 (in Japanese). <http://www.nilim.go.jp/japanese/organization/kenchiku/iinkai/20110818pdf/siryoul.pdf>
- [5.1] The Central Disaster Management Council, CAO (2008), Published Committee material, Committee for Technical Investigation on Tonankai-Nankai earthquake. (in Japanese)
- [5.2] The Headquarters for Earthquake Research Promotion, “Tentative Predictive Maps for Long-Period Earthquake Motions”, MEXT, September, 2009 (in Japanese)
- [5.3] Architectural Institute of Japan (2007), “Structural Response and Performance for Long Period Seismic Ground Motions,” AIJ. (in Japanese)
- [5.4] Okawa, I. et al., “Study on the Safety Countermeasures for Super-high-rise Buildings etc. against the Long-period Earthquake Ground Motions”, Building Research Data, No.127, December 2010, pp.1-453, Building Research Institute (in Japanese)
- [5.5] The Building Center of Japan (1986), Building Letter 1986.6, BCJ (in Japanese)
- [5.6] BRI and BCJ (1992), “Technical Guideline for Making Design Earthquake Motions,” BC J (in Japanese)
- [5.7] Kataoka, S. (2008), “Attenuation Relationship and Amplification Map for Ground Motion in Rather-Long Period Range”, Journal of the Japan Society for Civil Engineers, Vol.64, No.4, pp.721-738, (in Japanese)
- [5.8] Satoh, T. et.al. (2010), “Prediction of Waveforms of Long-Period Ground Motions for Hypothetical Earthquakes Using Empirical Regression Relations of Response Spectra and Phase Spectra,” J. Struct. Constr. Eng., AIJ, Vol.75, No.649, pp.521-530 (in Japanese)
- [5.9] Izumi, M., et.al., (1983), “A Fundamental Study on Extraction of Phase-Information in Earthquake Motions, Transactions of AIJ, Vol.327, pp.20-28 (in Japanese)
- [5.10] Ohsaki, Y., (1994), “Introduction to Spectral Analysis of Earthquake Motions”, Kajima Publishing Co. Ltd.(in Japanese)
- [5.11] Tsurugi, M., et.al. (2005), “A Strong Motion Prediction in Osaka Area for Tonankai-Nankai earthquake”, Proceedings of the Symposium on the Prediction of the Broadband Strong Motions, JSCE and AIJ. (in Japanese)
- [5.12] Sato, T., et. al. (2006), “Strong Motion Prediction for Hypothetical Tokai Earthquake by the Research Council on Design Input Motions in Aichi Prefecture,” Proceedings of the Symposium on the Prediction of the Broadband Strong Motions (2), JSCE and AIJ. (in Japanese)
- [5.13] Kamae, K., et.al. (2006), “Strong Motion Prediction in Kinki Region for Nankai Earthquake,” Proceedings of the 34th Symposium on Ground Vibration, AIJ (in Japanese)
- [5.14] Sekiguchi, H., et.al., (2006), “A Multi-Scale Inhomogeneous Model for the Prediction of Broadband Seismic Wave due to Mega-Interplate Earthquake and Its Application to Nankai Earthquake”, Proceedings of the Symposium on the Prediction of the Broadband Strong Motions (2), JSCE and AIJ.(in Japanese)
- [6.1] Yoshiaki Nakano: Design Load Evaluation for Tsunami Shelters based on Damage Observations after Indian Ocean Tsunami Disaster due to the 2004 Sumatra Earthquake, AIJ J. of Technology and Design, Vol.13 No.25, 337-340, Jun., 2007 (in Japanese)
- [6.2] Technical examination council on liquefaction countermeasures in MLIT (in Japanese). http://www.mlit.go.jp/report/press/kanbo08_hh_000142.html.
- [6.3] Technical examination and investigation council on liquefaction countermeasures in Urayasu City (in Japanese). <http://www.city.urayasu.chiba.jp/item26068.html>
- [6.4] Technical examination and investigation council on liquefaction countermeasures in Tokyo Metropolitan (in Japanese). <http://www.metro.tokyo.jp/INET/KONDAN/2011/07/4017k400.htm> (in Japanese).

Effects on Dams due to the 2011 off the Pacific Coast of Tohoku Earthquake

by

Yoshikazu Yamaguchi¹, Masafumi Kondo², Toshihide Kobori³ and Shinya Mitsuishi⁴

ABSTRACT

On March 11, 2011, The 2011 off the Pacific coast of Tohoku Earthquake occurred off the coast of the Tohoku Region of northeastern Japan. This report clarifies the impact on dams of this earthquake, which is the largest to occur in the history of Japan, outlines the results of special safety inspections performed immediately after the earthquake by dam managers, and summarizes the results of later detailed in-situ investigations by expert dam engineers. It also describes the characteristics of earthquake motion records observed at dams during this earthquake, and discusses future prospects for evaluating the seismic performance of dams during large earthquakes.

KEYWORDS: Dam, Detailed Investigation, Special Safety Inspection, Tohoku Earthquake

1. INTRODUCTION

At 2:46 p.m. (JST) on March 11, 2011, The 2011 off the Pacific coast of Tohoku Earthquake (hereinafter referred to as "The 2011 Tohoku Earthquake") occurred, striking mainly the Tohoku region of northeastern Japan and causing devastating damage. The number of dead or missing had exceeded 23,000 by the end of May 2011 [1]. At the many dams where earthquake motion at or above a specified level was observed, special safety inspections were immediately carried out by each dam manager and the results were reported to the Ministry of Land, Infrastructure, Transport and Tourism (MLIT). Among the dams constructed on rock foundation under the regulation, "*Cabinet Order Concerning Structural Standard for River Administration Facilities, etc.*", there were no dams with severe damages in spite of the

massive scale of the earthquake. However, an old earthfill embankment of an irrigation pond, which was constructed more than 60 years ago and located outside of regulated areas under the River Law, breached due to the earthquake [2]. This report outlines the results of special safety inspections reported by the dam managers, detailed in-situ investigations of the dams in the jurisdiction of the MLIT carried out by the MLIT and the Public Works Research Institute (PWRI), and the characteristics of the earthquake motions recorded at these dams.

2. SPECIAL SAFETY INSPECTIONS OF DAMS IMMEDIATELY AFTER THE EARTHQUAKE

At dams in river areas managed under the River Law, dam managers must conduct special safety inspections immediately after an earthquake in cases where earthquake motion of 25 gal or higher was recorded at the dam foundation or cases where earthquake motion of JMA seismic intensity of 4 or higher was observed at the nearest meteorological station. The special safety inspections include a primary inspection and a secondary inspection. The former is a visual inspection immediately after the earthquake, while the latter includes a later, more detailed visual inspection and a safety inspection based on various data measured by monitoring devices.

¹ Team Leader, Dam and Appurtenant Structures Research Team, Hydraulic Engineering Research Group, Public Works Research Institute, Tsukuba-shi, Ibaraki-ken 305-8516 Japan

² Deputy Team Leader, ditto

³ Researcher, ditto

⁴ Head, Water Management and Dam Division, River Department, National Institute for Land and Infrastructure Management, Ministry of Land, Infrastructure, Transport and Tourism, Tsukuba-shi, Ibaraki-ken 305-0804 Japan

Special safety inspections were carried out after the earthquake of March 11 at 363 dams (Table 1). Earthquake motion with peak acceleration of 100 gal or more at the foundation was observed at over 20 dams. Except for several dams where inspections could not be performed because the area had been designated as restricted due to damages to the nuclear plants, the special safety inspections were completed. Damages severe enough to threaten the safety of the dams and need emergency measures were not reported. Reported damages were mainly minor cracking of the dam crest paving, temporarily increased leakage and so on (Table 2).

Although this report does not cite details, some damages were reported from dams managed by water users for irrigation or power generation. For example, relatively wide and long cracks on the crest and cracks or slippage on the upstream or downstream slope of earthfill dams and cracks of the facing membrane and increased leakage at asphalt face rockfill dams (AFRDs) were found. At dams where some damages were found, measured data are continuously being monitored and detailed investigations for repair works are being conducted, and temporary safety measures such as reservoir drawdown or waterproof covering over the cracks have been performed as needed.

3. DETAILED INVESTIGATIONS OF DAMAGE TO DAMS

3.1 Outline of Detailed Investigations

The MLIT and PWRI conducted in-situ detailed investigations focusing on those dams managed by the MLIT where some damages had been reported, leakage had increased, or peak acceleration records were relatively severe, in order to confirm the state of damages reported in the results of the special safety inspections, evaluate the safety of the dams, and to study countermeasures as needed. Several dams where leakage had increased in association with a rise of reservoir water level caused by later rainfall or snowmelt were added to the dams to be investigated, though it was not clear whether the

increased leakage was related to the earthquake. Figure 1 shows the locations of dams investigated with a source fault model estimated by the Geospatial Information Authority of Japan (GSI) [3], while Table 3 outlines the investigation results. No damages severe enough to threaten the safety of dams were found at any of these dams.

3.2 Results of Detailed Investigations

3.2.1 Surikamigawa Dam

The Surikamigawa Dam, shown in Fig. 2, is a central earth core type rockfill dam with a height of 105 m completed in 2006. This earthquake increased the total leakage from approximately 70 L/min. to 100 L/min. and caused the following damages.

- Maximum earthquake-induced settlement of dam body of approximately 17 cm at the crest near the maximum cross section
- Cracking on pavement on the dam crest near both abutments, primarily in the stream direction (Photo 1).

As a result of the detailed investigation, it was concluded that there were no problems threatening the safety of the dam because of the following facts:

- The increased leakage and settlement caused by the earthquake were small relative to the scale of the dam.
- These values stabilized after the earthquake.
- The cracks in the crest pavement were narrow.
- No damages were found on the upstream and downstream surfaces.

In order to do everything possible to ensure safety, the manager is continuing to conduct careful monitoring, and has measured the depth of cracks. The results revealed that the cracks under the pavement terminated within the protective layer, and did not reach the dam section.

3.2.2 Ishibuchi Dam

The Ishibuchi Dam, shown in Fig. 3 is a concrete faced rockfill dam (CFRD) with a height of 53 m

completed in 1953. This earthquake caused the following damages.

- Maximum earthquake-induced settlement of the dam body of approximately 1 cm at the crest around the maximum cross section
- Cracking of the foundation of the crest railing

As a result of the detailed investigation, it was found that there were no problems threatening the safety of the dam, because the earthquake-induced settlement was small and no damages were found to the upstream concrete facing. The increase of measured leakage from approximately 2,000 L/min. to about 3,000 L/min. reported in the results of the special safety inspection were revealed to be due to blocking of the water level inside the channel where the amount of leakage is measured caused by adhering of algae. At this dam, a seismograph installed at the dam crest recorded a peak acceleration of 1,461 gal in the stream direction and 2,070 gal in the vertical direction during The Iwate-Miyagi Nairiku Earthquake in 2008 (Mj7.2, inland active fault earthquake). Damages due to the 2008 earthquake included rippled and cracked crest pavement and openings on the boundary between the crest paving and railings (Photo 2(a)) [4], while damages due to the 2011 Tohoku Earthquake (Photo 2(b)) were extremely minor.

3.2.3 Tase Dam

The Tase Dam, shown in Fig. 4, is a concrete gravity dam with a height of 81.5 m completed in 1954. This earthquake increased the total leakage from 14 L/min. to 69 L/min. and caused the following damages.

- Exfoliation of parapet concrete at the crest (Photo 3(a))
- Opening of cracks and level differences on crest paving (Photo 3(b))

As a result of the detailed investigation, it was decided that there were no problems threatening the safety of the dam considering the fact that leakage from each contraction joint was low at no more than about 10 L/min. and uplift pressure was not increased, though some leakage was generated from joint drain holes where it had

been almost zero before the event. Therefore, in order to do everything possible to ensure dam safety, the manager is continuing to conduct careful monitoring, paying close attention to the correlation of reservoir water level with leakage.

3.2.4 Kamuro Dam

The Kamuro Dam, shown in Fig. 5, is a concrete gravity dam with a height of 60.6 m completed in 1993. Approximately one month after the earthquake, leakage at the dam increased remarkably (Fig. 6), at around the same time that the reservoir water level began to raise caused by melting snow and rainfall in the upstream area and a relatively large aftershock (Mj7.4) on April 7. However, the peak acceleration (horizontal component) of seismic motion observed at the foundation of this dam was 18 gal by the main shock, and 15 gal by the aftershock, neither particularly high values. A similar situation occurred at the Takasaka Dam located nearby.

The results of the detailed investigation revealed that the increased leakage was conspicuous primarily at the drainage hole from the contraction joint 2J3 (Photo 4), and its quantity exceeds the maximum value at the same reservoir water level in the past at this dam. Neither increased uplift pressure or leakage from the foundation drain holes, nor exterior damage to the dam body were found.

In response to the results of the detailed investigations, the manager has stepped up monitoring of leakage and opening of joints, particularly the contraction joints, and also began an investigation to identify the leakage channels for taking countermeasures. The leakage has tended to stabilize after the detailed investigation, as shown in Fig. 6. Further analyses of the impact of earthquake motion on leakage should be conducted.

4. OBSERVED EARTHQUAKE MOTIONS

The River Bureau and National Institute for Land and Infrastructure Management, MLIT is collecting earthquake motion records including

seismic wave records observed at dams. Although only limited records have been collected to date, the properties of earthquake motion triggered by this earthquake are described below.

4.1 Peak Acceleration

Figure 7 shows the relationship of the peak acceleration of the horizontal earthquake motion observed at each dam foundation with the distance from the source faults modeled as shown in Fig. 1. The peak acceleration observed at each dam relatively far from the source fault of the offshore earthquake is not extremely large compared with records observed at dams near the epicenter of past inland active fault earthquakes, as shown in Table 4. Although it is necessary to examine its application to an extremely large-scale earthquake such as this event, the empirical formula [5] for estimating the peak acceleration spectrum at dam rock foundations is also shown in Fig. 7. The formula is used in consideration of the variation of earthquake motion to set the earthquake motion for evaluating the seismic performance of dams during large earthquakes [6], which is now under trial implementation by the MLIT.

4.2 Acceleration Time History

As examples, seismic motions observed at the foundation and crest of the Miharu Dam and Surikamigawa Dam during the earthquake are shown in Fig. 8 and Fig. 9, respectively. In Fig. 10, the value of peak acceleration and duration of principal motion at these dams are compared to the records observed at dam foundations during major earthquakes in recent years. Obviously, the duration of the earthquake motion of 2011 is longer than that of other records.

4.3 Acceleration Response Spectra

Figure 11 shows examples of normalized acceleration response spectra of earthquake motions observed at dam foundations during the earthquake of 2011 and several earthquakes in recent years. Although waveform data collected during the 2011 earthquake is still limited, the

long-period component is relatively somewhat larger than that of past inland active fault earthquakes, but this trend is not so strong in comparison with past interplate earthquakes. Further analyses using more waveform records are required to evaluate the impact of earthquake motion during the 2011 earthquake on the seismic behavior of dams.

5. CONCLUSIONS

Following The 2011 Tohoku Earthquake, which is the largest earthquake that has ever struck Japan, special safety inspections were carried out immediately, and the MLIT and PWRI conducted in-situ detailed investigations. As a result, among the dams in the jurisdiction of the MLIT, no damages severe enough to threaten safety were found at any of the dams. This appears to be because almost all Japanese dams, except earthfill dams, are constructed on rock foundation, and because the source fault of the earthquake was relatively far from the dams so the earthquake motion was not as strong as that observed at dams close to the epicenters of past inland active fault earthquakes.

On the other hand, the duration of earthquake motion was far longer than that of any past earthquake observed in Japan. The trial implementation to evaluate the seismic performance of dams considering maximum class earthquake motion is now continued in Japan. A characteristic of the earthquake motions observed in the 2011 earthquake suggests that it may be necessary to consider more severe damages to dams than previously assumed due to the cyclic action of earthquake motion which is not only extremely strong but also continues for a very long time.

Acknowledgments

The authors sincerely thank the managers of the dams for their cooperation with the detailed investigations and collection of seismic motion records.

6. REFERENCES

1. National Police Agency. Damage Situation and Police Countermeasures associated with 2011Tohoku district - off the Pacific Ocean Earthquake,
http://www.npa.go.jp/archive/keibi/biki/index_e.htm
2. Matsumoto,N., Sasaki,T., Amamiya,H. Impact on Dams of the Pacific Coast of Tohoku Earthquake –Southern Fukushima—. *Engineering for Dams*, No. 296, pp.48-54, 2011 (in Japanese)
3. Geospatial Information Authority of Japan. Crustal Deformation and Fault Model obtained from GEONET data analysis, <http://www.gsi.go.jp/cais/topic110422-index-e.html>
4. Yamaguchi,Y., Iwashita,T., Mitsuishi,S. Preliminary Investigation of Dams Stricken by the Iwate-Miyagi Nairiku Earthquake in 2008. 5th EADC International Symposium on Co-existence of Environment and Dams, 2008
5. Mitsuishi,S., Shimamoto,K. Seismic Performance Evaluation of Dams during Large Earthquakes. *Engineering for Dams*, No. 274, pp. 6-35, 2009 (in Japanese)
6. Shimamoto, K., Sasaki, T. and Kondo, M. Trial Implementation of New Japanese Guidelines for Seismic Performance Evaluation of Dams during Large Earthquakes. The 75th Annual Meeting of ICOLD, 2007
7. National Institute for Land and Infrastructure Management (NILIM), Ministry of Land, Infrastructure, Transport and Tourism, Public Works Research Institute(PWRI), Building Research Institute. Report on the damage survey of the 2008 Iwate-Miyagi Nairiku Earthquake. *Technical Note of the NILIM*, No. 486, *Technical Note of the PWRI*, No. 4120, *Technical Note of the Building Research Institute*, No. 115, 2008 (in Japanese)

Table 1 Numbers of dams where special safety inspections were conducted

Manager	Total	Concrete dams	Embankment dams	Combined dams
MLIT or Japan Water Agency	46 (11)	31 (6)	10 (3)	5 (2)
Prefectural Governments	104 (8)	81 (6)	22 (2)	1 (0)
Water users (Power generation-, Irrigation- and tap/industrial water supply- purpose)	213 (27)	107 (7)	101 (19)	5 (1)
Total	363 (46)	219 (19)	133 (24)	11(3)

* The figure in () represents number of dams where damages reported. Almost of them are minor except several cases at dams managed by water users.

Table 2 Typical damages reported in the results of special safety inspections

Dam type	Damages in relation to dam body
Concrete dams	- Minor cracks on dam crests - Increased leakage
Embankment dams	- Cracks on dam crest of earthfill dams - Cracks on upstream or downstream slopes of earthfill dams - Cracks on waterproof facing of Asphalt Faced Rockfill Dams

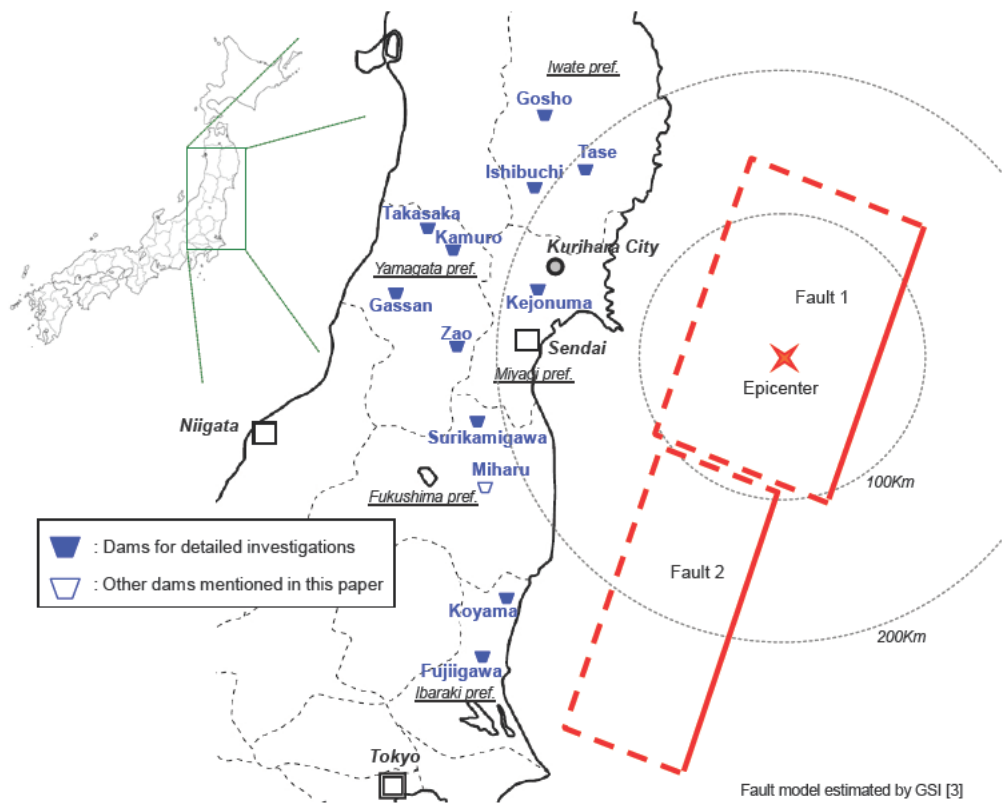

Fig. 1 Locations of dams for detailed investigations

Table 3 Outline of results of detailed investigations

Dam (Year of completion)	Manager	Type*	Height (m)	Epicentral distance (km)	PGA** (gal)	Results of special safety inspection	Results of detailed investigations
Surikamigawa (2006)	MLIT	ER	52.5	216	110	Dam crest cracking, Increased leakage	Max. EQ-induced settlement =approx. 17cm, Cracked pavement on dam crest (see 3.2.1.)
Ishibuchi (1953)	MLIT	CFRD	53	204	(184)	Dam crest cracking	Max. EQ-induced settlement = approx. 1cm, Cracked foundation of railing on dam crest (see 3.2.2.)
Tase (1954)	MLIT	PG	81.5	192	N.A.	Increased leakage	Exfoliation of parapet concrete on dam crest (see 3.2.3.)
Gosho (1981)	MLIT	PG, ER	105	237	39	-	Increase of leakage from contraction joints of concrete dam
Gassan*** (2001)	MLIT	PG	123	265	11	Increased leakage	Increase of leakage from contraction joints
Kejonuma (1995)	Miyagi Pref.	TE	24	176	269	Increased leakage	(Max. EQ-induced settlement = approx. 14cm Cracks on the crest
Zao (1970)	Yamagata Pref.	Hollow Gravity	66	212	91	Increased leakage	Increase of leakage from drainage holes installed in the foundation
Fujiigawa (1976)	Ibaraki Pref.	PG	37.5	289	174	Increased leakage	Increase of leakage from drainage holes installed in the foundation
Koyama (2005)	Ibaraki Pref.	PG	65	244	334	Increased leakage	Increase of leakage from contraction joints
Kamuro*** (1993)	Yamagata Pref.	PG	60.6	231	18	Increased leakage	Studying countermeasures on leakage from contraction joints (see 3.2.4.)
Takasaka*** (1967)	Yamagata Pref.	PG	57.0	254	25	Increased leakage	Studying countermeasures on leakage from contraction joints

* PG: Concrete gravity dam, ER: Earth core rockfill dam, CFRD: Concrete faced rockfill dam, TE: Earthfill dam

** Peak value of the horizontal component (stream or dam axis directions) recorded at dam foundation except Ishibuchi dam, where its seismometer is installed at right bank terrace (not bedrock).

*** Additional investigations concerning increased leakage approximately one month after the earthquake.

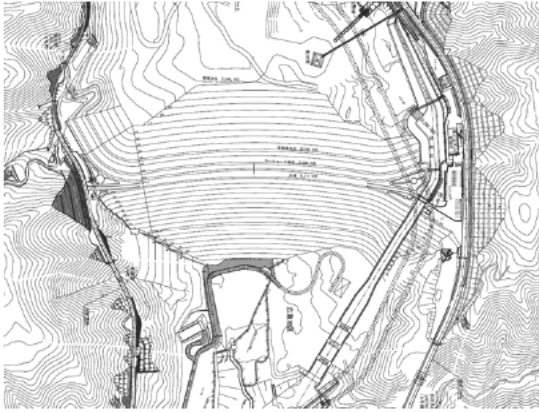

(a) Plan

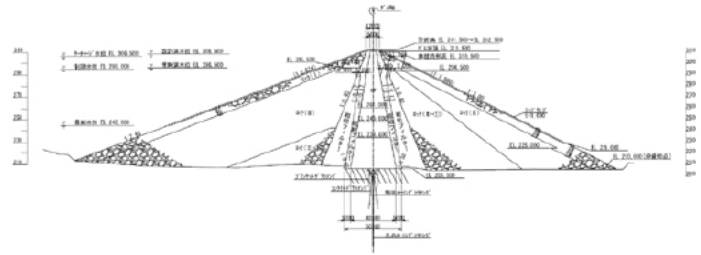

(b) Cross section

Fig. 2 Surikamigawa dam



(a) Overview of the crest



(b) Closeup of a crack

Photo 1 Cracking at crest of Surikamigawa dam

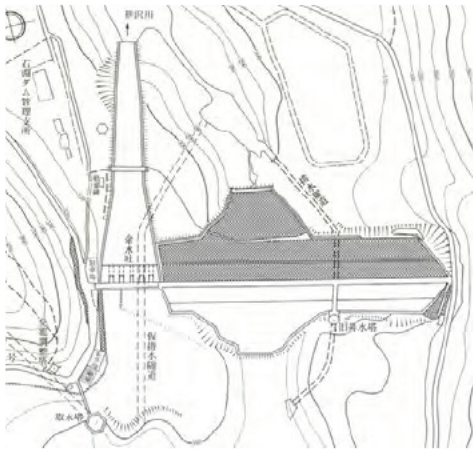

(a) Plan

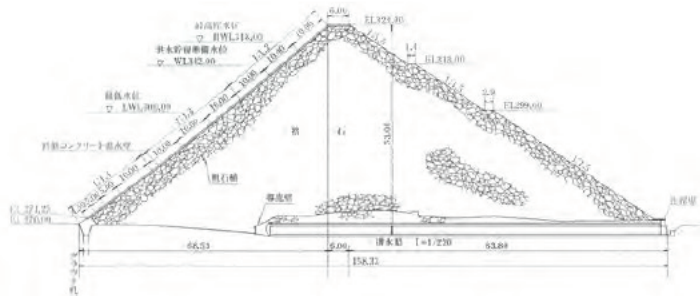

(b) Cross section

Fig. 3 Ishibuchi dam



(a) After the Event of 2008 [4]



(b) After the Event of 2011*

*Traces of repairs of paving followed the 2008 earthquake

Photo 2 Crest of Ishibuchi dam

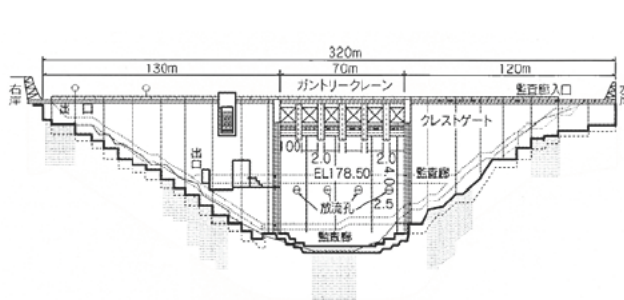

(a) Longitudinal section

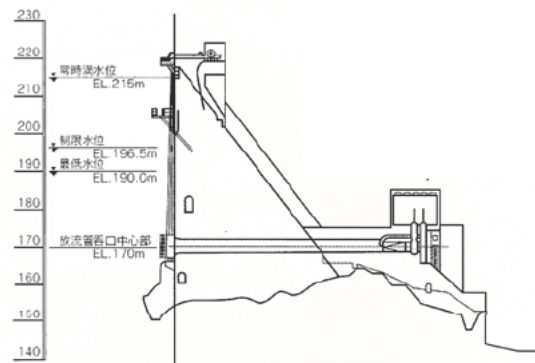

(b) Cross section

Fig. 4 Tase dam



(a) Exfoliation of parapet concrete



(b) Level difference at joint

Photo 3 Damages at crest of Tase dam

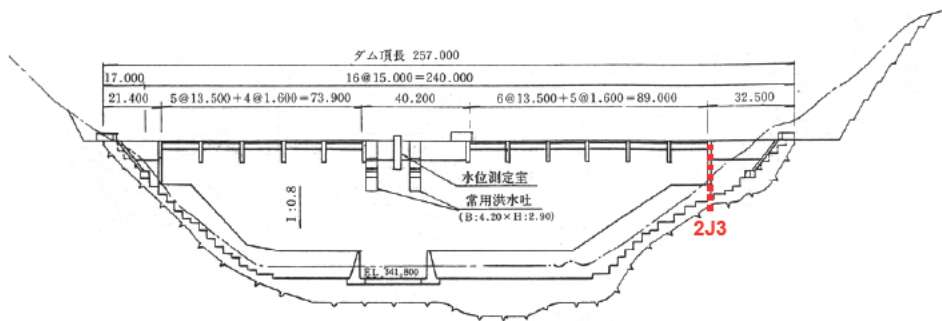

Fig. 5 Longitudinal section of Kamuro dam



(a) Contraction joint 2J3



(b) Leakage from contraction joint 2J3

Photo 4 Leakage from contraction joint of Kamuro dam

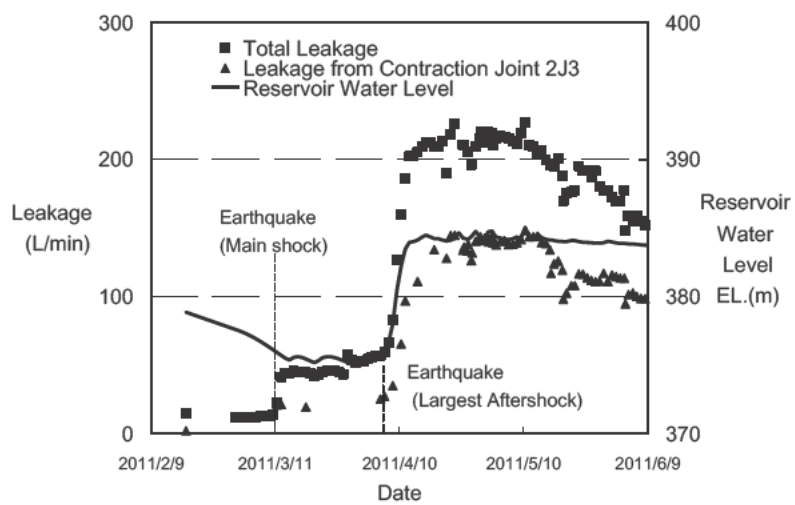

Fig. 6 Time history of leakage at Kamuro Dam

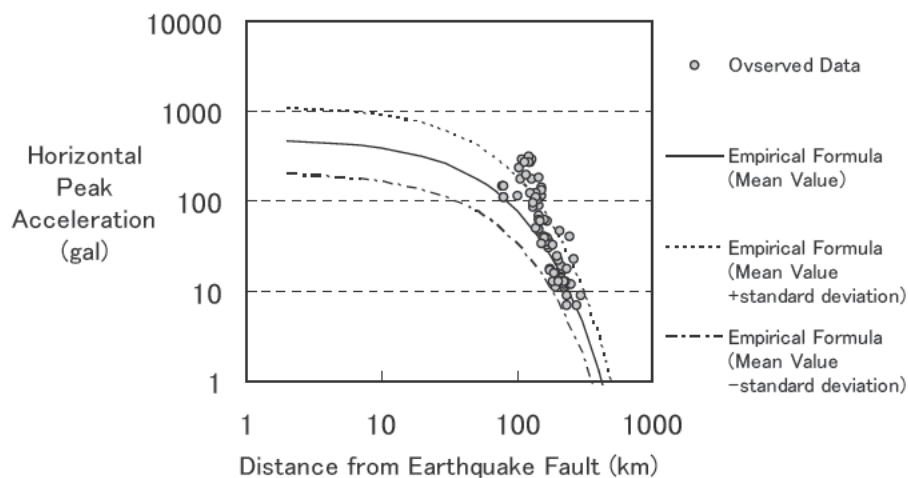

Fig. 7 Peak horizontal acceleration at dam foundation

Table 4 Large earthquake motion records at the dam foundation in recent years

Year	Earthquake			Dam		Distance * ** (km)	PGA **** (gal)
	Scale *	Type	Name	Type **			
1995	Southern Hyogo pref.(Kobe)	M _j 7.3	Active fault	Hitokura	PG	48	183
				Minohgawa	ER	48	135
2000	Western Tottori pref.	M _j 7.3	Active fault	Kasho	PG	12	569
2003	(Off Miyagi pref.)	M _j 7.1	Intraplate	Tase	PG	73	232
2003	Tokachi-oki	M _j 8.0	Interplate	Urakawa	PG	55	228
2004	Mid Niigata pref.	M _j 6.8	Active fault	Shirokawa	PG	115	103
2007	Noto hanto	M _j 6.9	Active fault	Hakkagawa	PG	14	162
2007	Niigataken chuetsu-oki	M _j 6.8	Active fault	Kakizaki -gawa	ER	31	170
2008	Iwate-Miyagi Nairiku	M _j 7.2	Active fault	Aratozawa	ER	16	(1024)
				Ishibuchi	CFRD	11.5	(657)
2011	Off the Pacific Coast of Tohoku	M _w 9.0	Interplate	Miharu	PG	230	195
				Surikamigawa	ER	216	110

* M_j: JMA magnitude, M_w: Moment magnitude ** PG: Concrete Gravity Dam, ER: Earth Core Rockfill Dam, CFRD: Concrete Faced Rockfill Dam, *** Epicentral distance **** Maximum value of horizontal component (stream direction or dam axis direction). PGA value for Aratozawa Dam (2008) may be the upper limit for measurement by seismometer. PGA value for Ishibuchi Dam (2008) is estimated value [7].

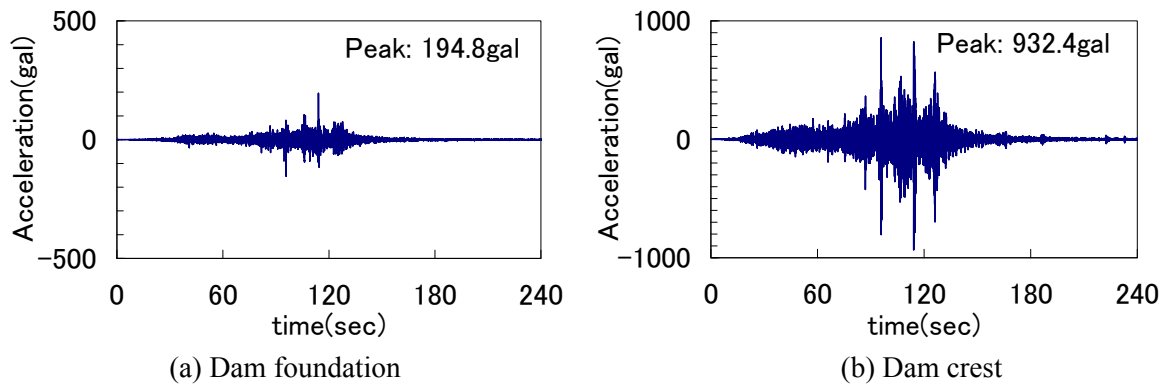

Fig. 8 Seismic motion observed at Miharu dam in stream direction

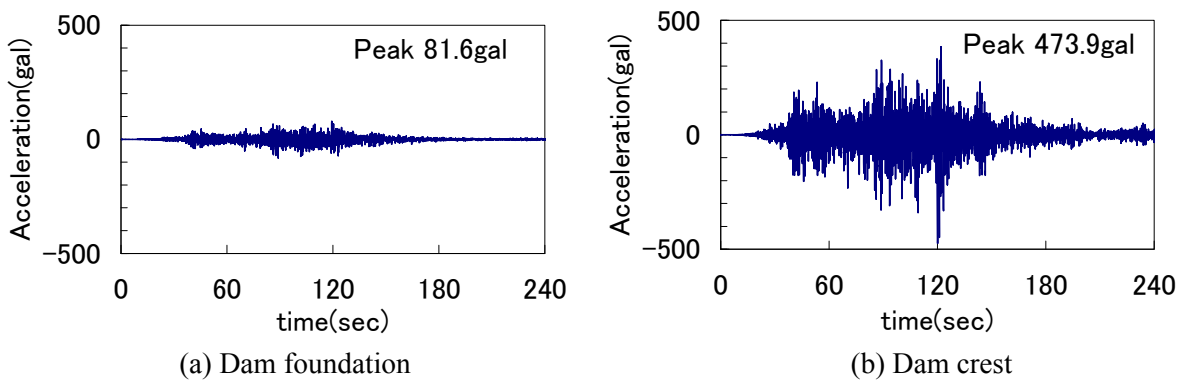

Fig. 9 Seismic motion observed at Surikamigawa dam in stream direction

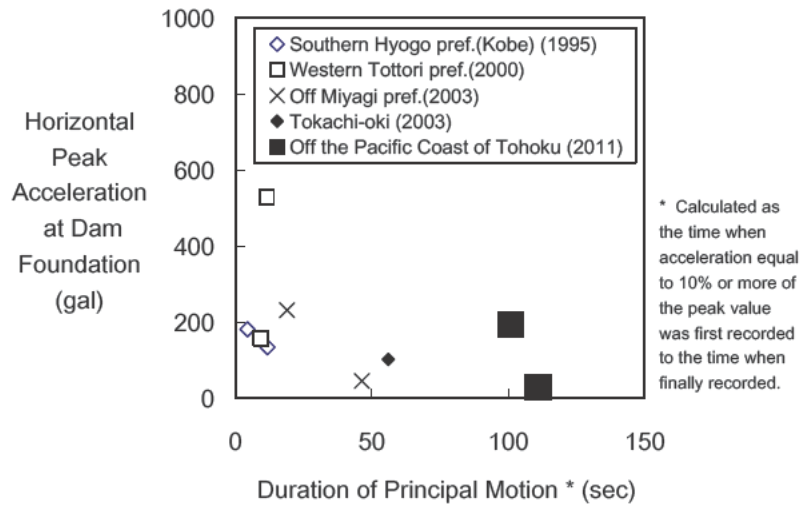

Fig. 10 Peak acceleration and duration of principal motion observed at dam foundations

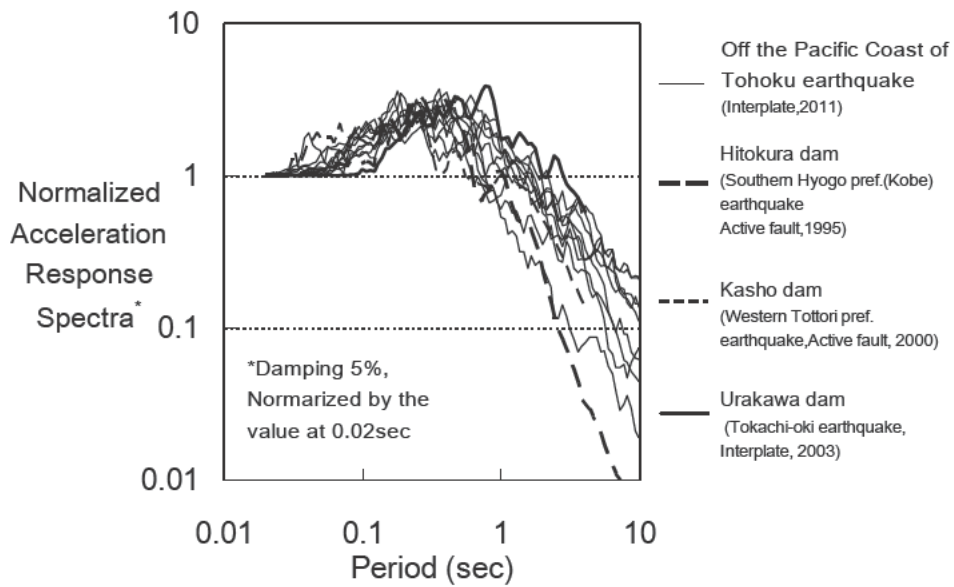

Fig. 11 Acceleration response spectra of earthquake motions observed at dam foundations in stream direction

U.S.-Japan Joint Reconnaissance Report of Bridge Damage due to 2011 Tohoku Earthquake

by

Tetsuro Kuwabara¹ and W. Phillip Yen²

ABSTRACT

Task committee G (Transportation) of the Panel of Wind and Seismic Effect, UJNR conducted the U.S.-Japan joint reconnaissance of bridge damage due to the 2011 Great East Japan Earthquake in June, 2011. Thirteen experts participated in this reconnaissance from both Japan-side and U.S.-side, and the reconnaissance team investigated 11 highway bridges in Tohoku and Kanto areas.

This paper summarizes the preliminary findings of the reconnaissance and lessons learned from the earthquake based on the joint reconnaissance.

KEYWORDS: 2011 Great East Japan Earthquake, Highway Bridges, Tsunami Effect, Seismic Retrofit, Long Duration

1. INTRODUCTION

The 2011 Great East Japan Earthquake occurred at 2:46 pm on March 11, 2011.

The catastrophic damages resulting from strong ground motion and huge tsunami remain in Tohoku and Kanto regions. More than 20,000 people were killed or missing, and various infrastructures were damaged, especially in the coastal area of Iwate, Miyagi, Fukushima and Ibaraki Prefectures.

Many highway bridges were also damaged in these areas due to both large ground motion and tsunami effects. Soon after the earthquake occurred, NILIM and CAESAR in PWRI jointly investigated bridge damage conditions and provided the technical supports and suggestions to bridge administrators, including Regional Bureaus of MLIT and Local Governments. Based on the primary investigation conducted by NILIM and CAESAR, Task Committee G conducted the U.S.-Japan joint reconnaissance to bridge damage during June 3 to 6, 2011. The joint reconnaissance focused on following points; damaged bridges due to tsunami or strong

ground motion effects, verification of seismic performance of bridges retrofitted after the 1995 Hyogo-ken Nambu earthquake, validations of effectiveness of the current seismic design specification policy.

2. OUTLINE OF EARTHQUAKES AND BRIDGE DAMAGE

2.1 Outline of Earthquakes

The main shock of this earthquake ($M_w=9.0$, focal depth=24km) occurred at 2:46 pm (JST) on March 11, 2011. Maximum seismic intensity was observed at Tsukidate, Kurihara city in Miyagi prefecture (Seismic intensity of JMA was 7) and large seismic intensities were observed in Tohoku and Kanto areas.

Figure 1 shows acceleration ground motion waveforms and spectral response accelerations at representative strong ground motion observation sites.

It should be noted that 1) strong ground motion records with long duration were observed and 2) there were multiple pulses in some ground motion records observed near epicenter. This is because large fault areas collapsed continuously. It was observed at very large maximum response acceleration at the range of short predominant period such as Tsukidate record. The maximum response accelerations at the range of natural periods from 1.0 to 2.0 seconds, which relatively correlate with damage of ordinary road bridges, were equal or slightly less than those of the 1995 Hyogo-ken Nambu earthquake. Ground motions and maximum response accelerations at the coastal area of Tohoku region were not so large. However, strong ground motions and large

¹ Director, Center for Advanced Engineering Structural Assessment and Research, Public Works Research Institute, Tsukuba-shi, Ibaraki-ken 305-8516 Japan

² Principal Bridge Engineer - Structural Dynamics, Office of Bridge Technology, Federal Highway Administration, 1200 New Jersey Ave. SE, Washington, DC 20590, USA

response accelerations were observed at the sites where located slightly far from epicenter such as Fukushima, Tochigi and Ibaraki prefectures.

Huge tsunami induced by main shock struck at Tohoku and Kanto coastal areas and exceeding 10m in height of wave were observed.

Moreover, aftershocks with the JMA magnitude of 7.0 or over were occurred three times within a day and total of 89 aftershocks with the magnitude of 6.0 or over were occurred until August 3.

Additionally, large earthquakes induced by Tohoku earthquake were occurred at far site from fault area of Tohoku earthquake such as Nagano Prefecture (March 12, $M_{JMA}=6.7$ (tentative)) and Sizuoka Prefecture (March 15, $M_{JMA}=6.4$ (tentative)).

2.2 Outline of Bridge Damage

Damage of the highway bridges due to this earthquake can be categorized as follows:

- Effect of tsunami,
- Effect of strong ground motion, and
- Effect of soil liquefaction

Many highway bridges were damaged by tsunami. Twelve bridges including service road for pedestrian were washed away on national highway route 45, which was main route along the Pacific coast of Tohoku Area. Total of about 80 highway bridges were fallen down due to tsunami in Iwate, Miyagi, Fukushima, Ibaraki and Chiba prefectures. The backfill of abutment in some bridges were washed out even though girders and substructures were survived.

Rokko Ohashi Bridge, a steel girder bridge supported by steel pile-bent columns located in Ibaraki prefecture, was collapsed by the effects of strong ground motion. It was also found that damage to RC columns at section of cut-off of longitudinal rebars, damage to RC pier-wall with small amount of reinforcement, damage to steel bearings and attachment of bearings, damage to bracing and steel members, and subsidence of backfill soil of abutment. It should be noted that elastometric rubber bearings were ruptured at the Sendai-Tohbu viaduct designed based on Post-

Kobe Earthquake specification.

Because of subsidence of backfill soil of abutment due to the soil liquefaction effect, deck-end gap was shortened resulting from movement of substructure, which caused steel bearings damage and parapet wall cracks.

The typical damages were shown in Figure 2.

3. JOINT RECONNAISSANCE OF BRIDGES

A joint reconnaissance team of highway bridges was organized and perform the post-earthquake investigation during June 3rd to 6th. Seven Japanese and six U.S. experts participated in the team. Both sides' members were as follows,

Japan side;

Tetsuro Kuwabara, TC/G chair, PWRI
Kazuhiko Kawashima, Tokyo Institute of Tech.
Keiichi Tamura, PWRI
Shigeki Unjoh, NILIM
Jun-ichi Hoshikuma, PWRI
Taku Hanai, PWRI
Hideaki Nishida, PWRI

U.S. side;

W. Phillip Yen, TC/G chair, FHWA
Ian Buckle, University of Nevada Reno
David Frost, Georgia Institute of Tech.
Shideh Dashti, University of Colorado
Eric Monzon, University of Nevada, Reno
Lee Marsh, Berger/ABAM Engineers

Total of 11 highway bridges were investigated at Tohoku and Kanto regions; 4 bridges damaged by tsunami, 5 bridges damaged by strong ground motion and 2 retrofitted bridges.

Table 1 lists the bridges that the team investigated, and Figure 3 shows the location map of the bridges except Arakawa Wangan Bridge (because it is located in Tokyo.). Additionally, the team investigated other infrastructure damaged due to liquefaction at Urayasu area in Chiba Prefecture.

3.1 Bridge Damaged by Tsunami

The team investigated four damaged bridges

due to tsunami, which were located at Kesenuma city and Minami-Sanriku Town in North part of Miyagi prefecture.

3.1.1 Koizumi Ohashi Bridge (see Figure 4)

This bridge was a 6-span steel girder bridge (two three-span-continuous girders) across Tsuya River. Substructure consisted of RC pier walls with steel pipe piles. The pier walls have been retrofitted by wrapping up with FRP sheets for P2 and P4; and installing dampers between abutment and girder. The height of Tsunami was estimated exceeding 10 meter high in this area.

All girders and one RC pier-wall (P3) were washed away to the upstream direction. The girders were rested about 450m far from original position.

P3 pier-wall, originally supported two girders with movable bearing support, was found about 50m away from original position. This pier was broken at the bottom (top of footing). The possible reason for only P3 being washed away was due to the ultimate strength of the pier-wall was weaker than the other piers.

Moreover, backfill soil of abutment was also washed out at both sides.

A railroad bridge located about 1km far from Koizumi Ohashi Bridge to upstream direction of Tsuya river was also collapsed. Girders were washed away and RC columns were leaned to upstream directions.

3.1.2 Sodeogawa Bridge (see Figure 5)

Sodeogawa Bridge is a 4-span RC hollow slab bridge located next to Koizumi Ohashi Bridge.

This bridge was not washed away except for the upstream side 3 girders of service road for pedestrian. Moreover, one of two-span-continuous box culvert with downstream side of service road for pedestrian was leaned by unequal settlement of supporting layer. Backfill soil was washed out at Koizumi Ohashi side.

3.1.3 Nijyuichihama Bridge (see Figure 6)

Nijyuichihama Bridge is a single-span PC hollow slab bridge. This bridge was not washed away

except the seaside girder of service road for pedestrian. However, traffic could not be opened after the earthquake because backfill soil of abutment was washed out at both sides. It was found that the steel pile head of abutment exposed by scouring due to tsunami.

At the time the team visited, temporary repair work had been finished and temporary steel girders were set at the part of backfill soil.

3.1.4 Utatsu Ohashi Bridge (see Figure 7)

Utatsu Ohashi Bridge is a 12-span PC single girder bridge. Piers consisted of circular RC column (P1 and P2) and rectangular RC column with PC piles. Bridge columns have been retrofitted by RC jacketing and an extension for the seat length was installed at the top of pier. Total of 8 spans (from P2 to P10) were washed away to the inland direction. It was found that concrete and steel shear keys, installed at the pier beam, were damaged and some beams of inland side were cracked at the piers which girders were washed away as well. A lot of diagonal cracks were also observed at the bottom of main girders of some unseated girders.

At the top of column of P2, cover concrete of additional portion of concrete jacketing was spalled.

3.2 Bridge Damaged by Strong Ground Motion

Five damaged bridges due to strong ground motion were investigated.

3.2.1 Sendai-Tohbu Viaduct (see Figure 8)

Sendai-Tohbu Viaduct is designed in accordance with the 1996 seismic design specification revised soon after the 1995 Hyogo-ken Nambu Earthquake.

At the damaged part of bridge, it was a 4-span steel box girder (Pier No.52 to No.56) adjoining a 2-span steel girder (Pier No.56 to No.58).

It was found that elastometric rubber bearings at pier No.52, No. 54 No.56 and No.58 were ruptured and some of superstructures were separated from bearings. This section was closed about 3 weeks until temporary repair work was done. Some yielded members were repaired by adding stiffeners, and superstructures were reset

at the original positions.

3.2.2 Ezaki Ohashi Bridge (see Figure 9)

Ezaki Ohashi Bridge is a 9-span continuous PC box girder bridge across Kitakami River. Substructure consisted of RC pier walls with caisson (P1 to P4) and spread footing (P5 to P8). Two damper stoppers were installed for each pier top to disperse seismic force.

Shear crack, spalling cover concrete and buckling of longitudinal rebars were found at the cut-off cross section of P5, P6, P7 and P8. The heights of these piers were lower than the other piers. At the time when the team visited, temporary repair work for piers had been finished by wrapping up with carbon fiber sheet.

3.2.3 Shida Bridge (see Figure 10)

Shida Bridge is a 9-span cantilever steel girder bridge across Naruse River. Spalling cover concrete at piers, settlement of backfill soil, and residual displacement by moving of superstructure was found.

3.2.4 Fuji Bridge (see Figure 11)

Fuji Bridge was a 13-span steel girder bridge across Kitakami River. It is interesting that this bridge was damaged due to not the main shock but the aftershock with magnitude of 7.1 occurred on April 7.

Shear crack, spalling concrete and buckling of longitudinal rebars were observed at the piers and the pin in the steel bearings was ruptured.

At the time when the team visited, temporary repair work for piers was done by wrapping up with carbon fiber sheet or PC cable confining method.

3.2.5 Arakawa Wangan Bridge (see Figure 12)

Arakawa Wangan Bridge is a 7-span cantilever truss bridge across Arakawa River. When main shock occurred, seismic retrofit works installing additional bracings were to start and scaffolding was built through the main truss member.

Total of 31 points such as connections between buttress strut and lateral bracing or cross frame were damaged. Temporary repair work had already done and traffic was opened when the team investigated.

It should be noted in this bridge that the scaffolding for the construction helps quick bridge inspection soon after the earthquake.

3.3 Verification of Seismic Retrofit of Bridges

The off Miyagi prefecture earthquake with JMA magnitude of 7.4 occurred in June 12, 1978. It should be interesting to compare the damage between the 1978 off Miyagi prefecture earthquake and the 2011 Great East Japan Earthquake. Following two bridges were damaged due to 1978 earthquake and then retrofitted after the earthquake.

3.3.1 Sendai Ohashi Bridge (see Figure 13)

Sendai Ohashi is a 9-span steel girder bridge across Hirose River. At the 1978 earthquake, piers were damaged by spalling cover concrete and buckling of longitudinal rebars, so that RC jacketing and resin grouting were done as repair work. Additionally, replace of bearing to rubber bearing, install the unseating protection systems and retrofit of pier by carbon fiber were done later.

No significant structural damage was found in this bridge due to the 2011 earthquake.

3.3.2 Yuriage Ohashi Bridge (see Figure 14)

Yuriage Ohashi Bridge is a 7-span with simple-supported PC girder, and 3-span simple-supported PC cantilever box girder bridge across Natori River. At the 1978 earthquake, columns were damaged with spalling cover concrete, shear crack at web of PC girder near bearing, moving to roller bearing, so that RC jacketing and resin grouting were done as repair work.

These retrofitted columns in Yuriage Ohashi Bridge were no damage during this earthquake, however damage of bearing supports and cracking at the end of PC girder were observed. It should be noted that tsunami attached Yuriage Ohashi Bridge after the earthquake. However the effect of tsunami on the damage of Yuriage Bridge was unclear, since tsunami height at this site was uncertain.

4. IMPACT OF 2011 GREAT EAST JAPAN EARTHQUAKE ON SEISMIC DESIGN OF HIGHWAY BRIDGES

The seismic performance of highway bridges, designed in accordance with the post-Kobe Japanese specifications, was very well and these bridges were functional without any long-term traffic stops after the earthquake. However, there are several important issues and lessons we should study and review for the latest seismic design specifications for highway bridges. Followings are the selected issues.

4.1 Ground Motion

4.1.1 Effect of Long Duration Earthquake on Seismic Performance of Bridges

In the 2011 Great East Japan Earthquake, many strong ground motion records were recorded and these records clearly showed that this earthquake generated ground motions with multiple pulses and thus the longer duration (more than 2 minutes) than other records observed in the past earthquakes. Similar ground motions were reported in the 2010 Chile Earthquake with the moment magnitude Mw 8.8. Therefore, the subduction-type earthquake with Mw of nearly 9 may induce the ground motion with long duration.

In general, the long duration would affect the number of cyclic inelastic response of the bridge system. Past experimental researches indicated that the loading pattern in the quasi-static cyclic loading test, particularly the number of cyclic loading affects the ductility capacity of flexural reinforced concrete column. In order to accommodate such effect into the seismic design, Japanese design specifications have determined two ductility/shear capacity factors based on the types of the ground motion, i.e. the subduction-type and the near-fault-type. Re-studies on the effect of the long duration will be required based on the ground motion observed in the 2011 Great East Japan Earthquake.

The long duration would also affect the soil liquefaction. Effect of the soil liquefaction on the seismic design of bridge foundation was introduced in the 1971 specifications in Japan based on the lessons learned from the 1964

Niigata Earthquake. Although there were no major liquefaction-induced damages in bridges during the 2011 Great East Japan Earthquake, the long duration effect on the bridge performance built on the liquefiable sandy soil condition should be verified through both geological and structural perspectives.

4.1.2 Properties of Ground Motion and Damage of Bridges

Since the ground motion effect propagated wide, bridge damage developed in wide area. Many ground motion records were also observed in wide area. It should be important to study the relation between the properties of the ground motion and damage of bridges.

4.2 Tsunami Effect on Bridges

Superstructures in several bridges were washed away due to the tsunami effect. Backfill soil for the abutment was also washed out. Similar damage modes in bridge were also observed during the 2004 Indian Ocean Earthquake. Failure mechanism of bridge system due to the tsunami effect need to be studied, in which the resistance capacity of the existing bearing supports be analyzed based on both the washed-away and survived bridges. Also, more experimental researches on the bridge behavior due to the tsunami effect are required, to find the appropriate structural system for mitigating the tsunami effect.

Bridge design with hold-down devices in preventing wind uplifting forces may be considered as one countermeasure in the tsunami area as the bridge failure scenarios may involve buoyancy forces from water. Restrainers installed for wind uplifting forces may also work in relative small tsunami.

On the other hand, the design concept of bridge for unexpected extraordinary event would be controversial, because structural resistance capacity has a limit. Basically, it would be one of the options for the extraordinary tsunami effect to avoid routing important highway network and locating important bridges in the tsunami-risk area. In terms of structural engineering, easy-to-

repair bridge system is also another option.

4.3 Validations of Effectiveness of Seismic Retrofit

Seismic retrofit have been performed step-by-step since 1995 Kobe earthquake. Based on the lessons learned from the past earthquakes, bridge columns in the important highway network designed by pre-1980 specifications have been retrofitted with high prioritization. Many seismic vulnerable bridges in the important route such as National Highway Route 4, 6, 45 etc were retrofitted up to the date of the earthquake, which resulted in quick recovery of the functional highway network after the earthquake. It should be important review to investigate details of minor damage in the retrofitted bridges and evaluate the seismic behavior of the bridge during the earthquake.

5. CONCLUDING REMARKS

Bridge seismic performance was very well under this huge devastated earthquake although some bridge spans were washed out by great tsunami impacting and other combination forces. There are many lessons learned from this unique

earthquake, including long duration impact, tsunami effects. Bridges designed with newer design codes performed much better than those older one. The better we understand the bridge seismic characteristic response, the better we can improve our bridge seismic safety.

Earthquakes are inevitable hazards. However, the better we prepared for the earthquake hazard, the better we reduce the loss due to the earthquakes. Through the joint reconnaissance, the US and Japanese side shared the experience and technology developed, and work together to reduce the loss of earthquake hazards.

6. REFERENCES

1. Genda Chen, Phillip W. Yen, Ian Buckle, Tony Allen, Daniel Alzamora, Jeffrey Ger and Juan G. Arias: 2010 Chile Earthquake Implication to the Seismic Design of Bridges, *Proc. 26th US- Japan Bridge Engineering Workshop*, 2010.
2. K. Kawashima, S. Unjoh, J. Hoshikuma and K. Kosa: Damage Characteristic of Bridges due to 2010 Chile Earthquake, *Proc. 26th US- Japan Bridge Engineering Workshop*, 2010.

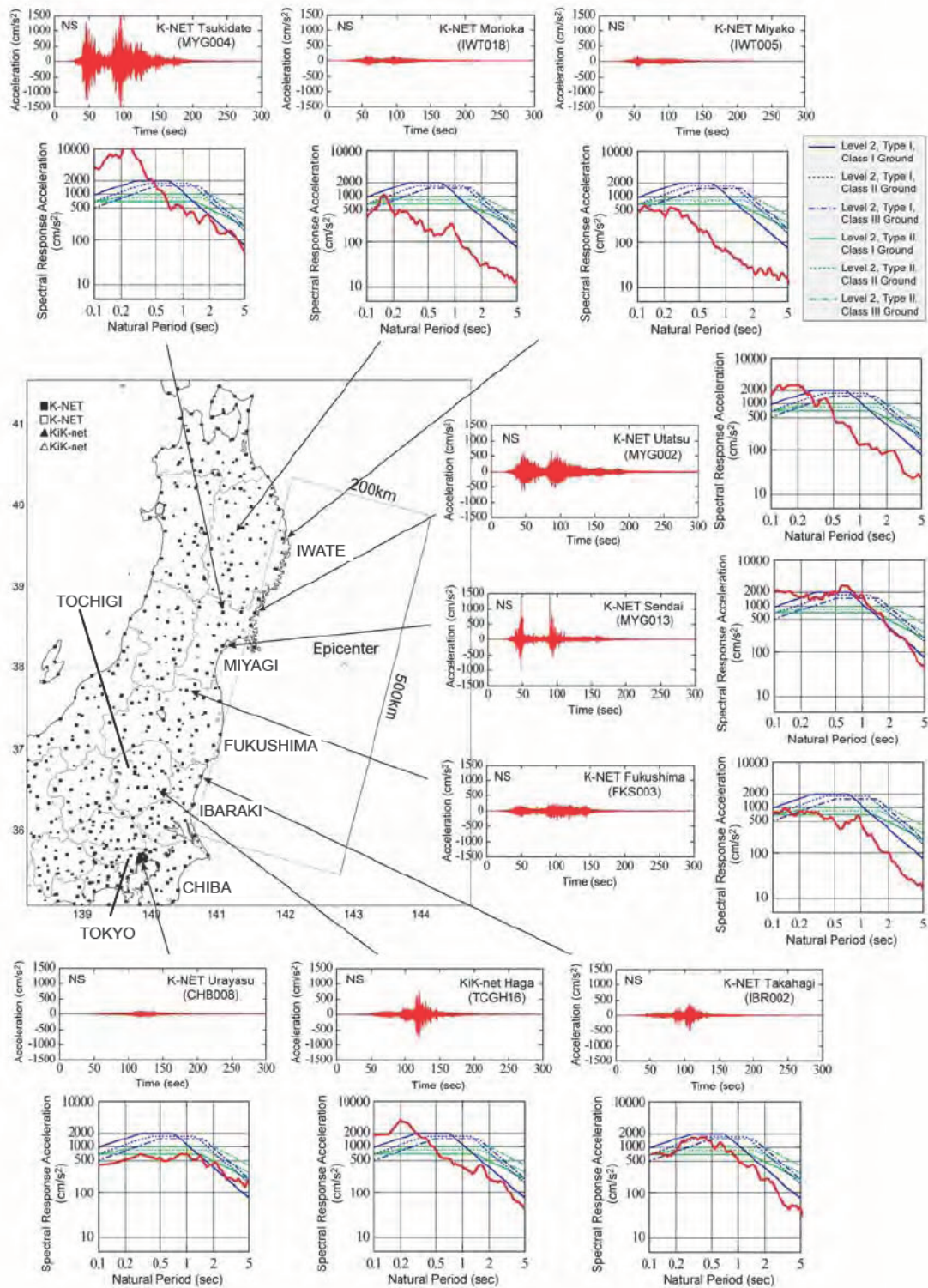

Fig. 1 Acceleration Waveforms and Spectral Response Acceleration at Main Shock (NS comp.)



(a) Collapse of Bridge with Pile-bent Columns



(b) Damage to RC Pier Wall with Small Amount of Reinforcement



(c) Damage to Pier Top



(d) Subsidence of Deck-End Resulting from Broken Movable Bearing

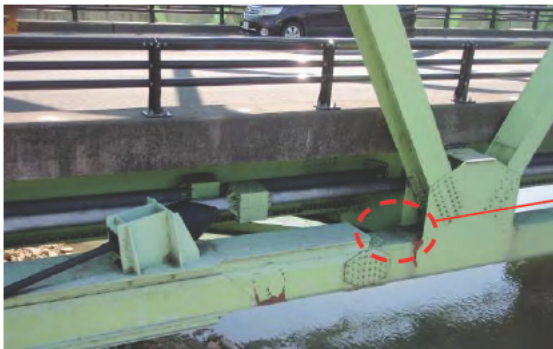

(e) Slight Buckling and Crack Observed in Lower Chord Member

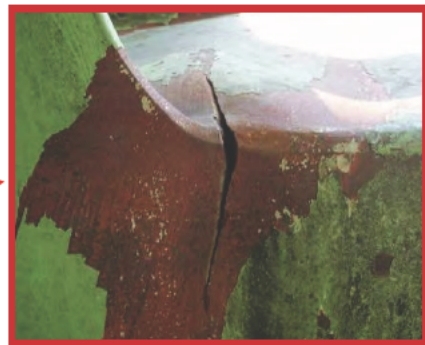

Fig.2(1) Typical Bridge Damages (by Effect of Strong Ground Motion)



(a) Shortened Deck-end Gap Resulting from Movement of Abutment



(b) Subsidence of Soil



(c) Subsidence of Backfill soil of Abutment



Fig.2(2) Typical Bridge Damages (by Effect of Soil Liquefaction)

Table 1 List of Investigation Bridges

No.	Name of Bridge	Const. year	Length (m)
1	Sendai-Tohbu viaduct	2000	4390
2	Koizumi Ohashi Br.	1975	182.1
3	Sodeogawa Br.	1972	60
4	Nijyuichihama Br.	1971	16.64
5	Utatsu Ohashi Br.	1972	303.6
6	Shida Br.	1958	266
7	Sendai Ohashi Br.	1965	310.0
8	Yuriage Ohashi Br.	1974	541.7
9	Ezaki Ohashi Br.	1982	586.2
10	Fuji Br.	1972	705
11	Arakawa Wangan Br. (Tokyo)	1978	840

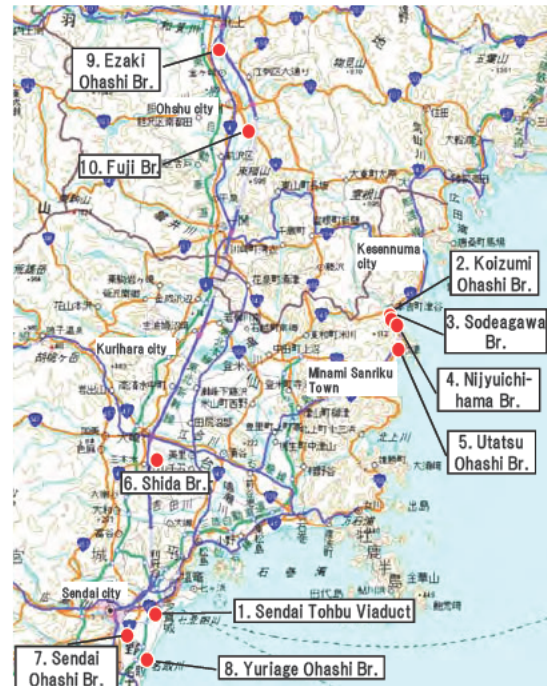

Fig.3 Locations of Investigation Bridges

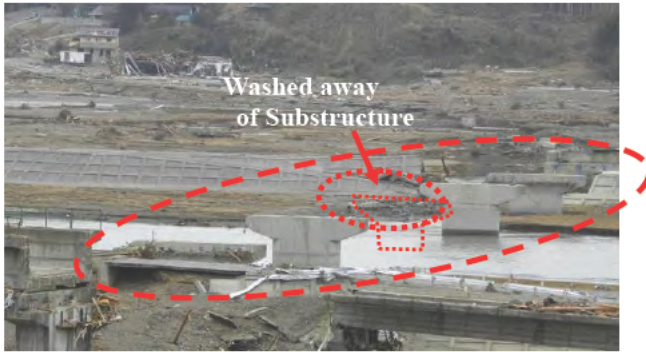

Fig.4(1) Koizumi Ohashi Br. (March 15)



Fig.4(2) Wash Away of Steel Girder of Koizumi Ohashi Br. (June 4)



Fig.4(3) Collapsed Railway Bridge Columns near Koizumi Ohashi Br. (June 4)



Fig.5 Sodeogawa Br. (June 4)



Fig.6(1) Nijyuichihama Br. (March 15)



Fig.6(2) Nijyuichihama Br. (Before earthquake, provided from Tohoku Regional Development Bureau, MLIT)



Fig.6(3) Nijyuichihama Br. (April 9, provided from Tohoku Regional Development Bureau, MLIT)



Fig.6(4) Nijyuichihama Br. (June 4)



Fig.7(1) Utatsu Ohashi Br. (June 4)



Fig.7(2) Utatsu Ohashi Br. (June 4)



Fig.7(3) Utatsu Ohashi Br. (March 19, provided from Tohoku Regional Development Bureau, MLIT)



Fig.8(1) Sendai-Tohbu Viaduct (June 3)



Fig.8(2) Sendai-Tohbu Viaduct (June 3)



Fig.8(3) Rupture of Rubber Bearing on Pier No.54 (April 6)



Fig.8(4) Rupture of Rubber Bearing (April 6)



Fig.9(1) Ezaki Ohashi Br. (April 6)



Fig.9(2) Ezaki Ohashi Br. (June 5)



Fig.9(3) Ezaki Ohashi Br. (June 5)

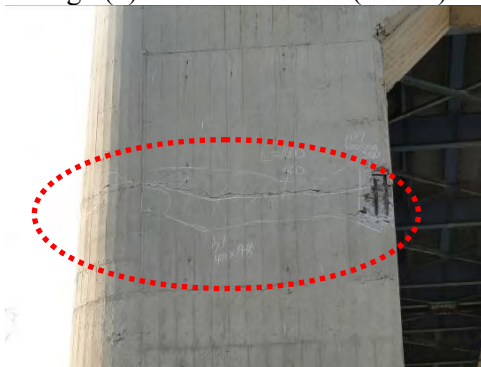

Fig.10 Shida Br. (April 7)



Fig.11(1) Fuji Br. (April 26)



Fig.11(2) Fuji Br. (June 5)



Fig.12(1) Arakawa Wangan Br. (June 6)



Fig.12(2) Arakawa Wangan Br. (June 6)



Fig.13 Sendai Ohashi Br. (June 5)



Fig.14 Yuriage Ohashi Br. (June 5)

Damage of Bridges during 2011 Great East Japan Earthquake

by

Kazuhiko Kawashima¹, Kenji Kosa², Yoshikazu Takahashi³, Mitsuyoshi Akiyama⁴, Tsutomu Nishioka⁵, Gakuho Watanabe⁶, Hirohisa Koga⁷, and Hiroshi Matsuzaki⁸

ABSTRACT

This paper presents damage of road and railway bridges during the Great East Japan earthquake and tsunami on March 11, 2011 based on a JSCE damage investigation. Ground motion induced damage and tsunami induced damage of both road and railways bridges are presented.

KEYWORDS: Great East Japan Earthquake, Damage Investigation, Seismic Damage, Bridges, Tsunami, Seismic Design, Seismic Retrofit

1. INTRODUCTION

The Great East Japan earthquake (Off Pacific Coast of Tohoku Region, Japan earthquake) with moment magnitude of 9.0 occurred at 14:46 (local time) on March 11, 2011 along the Japan Trough in the Pacific. It was the sixth largest earthquake ever recorded in the world. The fault zone extended 450 km and 200 km in the north-south and west-east directions, respectively. Extensive damage occurred in the wide region in the east part of Japan.

The authors were dispatched by Japan Society of Civil Engineers for field damage investigation to bridges in Miyagi-ken and Iwate-ken between March 29-April 3, 2011. In addition to the first investigation, damage investigations were conducted several times. Since 1978 Miyagi-ken-oki earthquake and 2003 Sanriku-Minami earthquake affected this region, an emphasis was placed in the damage investigation to compare damage among 2011 Great East Japan earthquake and two previous earthquakes. This paper presents ground motion induced damage and tsunami induced damage of bridges during 2011 Great East Japan earthquake.

2. GROUND MOTIONS AND TSUNAMI

2.1 Ground Motions

A number of strong motion accelerations were recorded by the National Institute of Earth Science and Disaster Prevention and Japan Meteorological Agency. Fig. 1 shows measured accelerations along the Pacific coast. Ground accelerations continued over 300s, and had at least two groups reflecting the fault rupture process. The highest peak ground acceleration of 27.0 m/s² was recorded at Tsukidate. However the high acceleration was resulted from a single pulse with high frequency components, and the response acceleration at 1.0 s was only 5.1 m/s². Damage of buildings and other infrastructures was minor in Tsukidate.

Fig. 2 shows acceleration response spectra at 15 sites in the flat region north of Sendai. It is general trend that high frequency components were predominant in the measured accelerations. However Fig. 3 shows ground accelerations and response accelerations of the records at Furukawa where soil condition is very weak such that the shear wave velocity is 80m/s at 2m thick top soil and 120 m/s between 2 m and 17 m below the ground surface. The response accelerations in the lateral components were nearly 15 m/s² at period between 0.2 s and 0.8 s, and 3-5 m/s² at 2 s period.

¹ Professor, Tokyo Institute of Technology, Tokyo, Japan

² Professor, Kyusyu Institute of Technology, Kita-Kyusyu, Japan

³ Associate Professor, Disaster Prevention Research Institute, Kyoto University, Uji, Japan

⁴ Professor, Waseda University, Tokyo, Japan

⁵ Hanshin Expressway Co., Osaka, Japan

⁶ Associate Professor, Yamaguchi University, Yamaguchi, Japan

⁷ Research Engineer, Public Works research Institute, Tsukuba Science City, Japan

⁸ Assistant Professor, Tokyo Institute of Technology, Tokyo, Japan

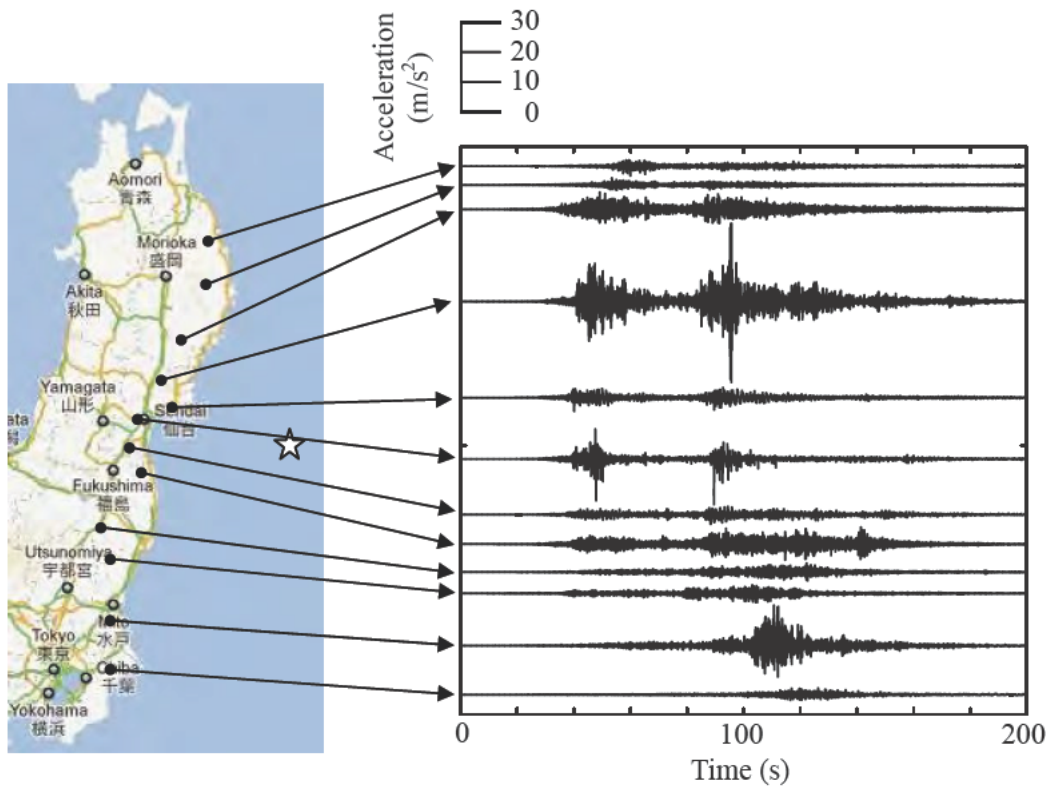

Fig. 1 Accelerations recorded by NIED

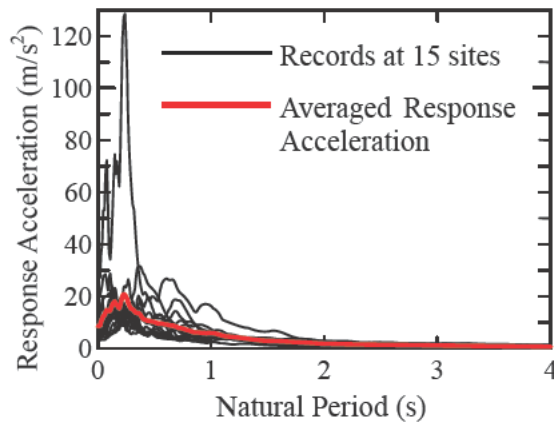

Fig. 2 Response accelerations ($\xi=0.05$) at 15 sites at the flat land north of Sendai City

Ground accelerations with similar trend were recorded at other soft soil sites such as K-NET Ichinoseki and Sendai and JMA Tome and Wakuya.

2.2 Tsunami

Tsunami attacked coastal region as soon as 30 minutes after the earthquake. Tsunami inundation

area reached as far as 10 km inland, engulfing virtually everything including peoples and structures. Japan Meteorological Agency (JMA) tidal stations recorded high tsunami at many locations. The highest tsunami was recorded 8.5m at Miyako. However due to saturation of the instrument, it must be higher than 8.5m. Other recorded heights at JMA stations include over 8.0 m in Ofunato and over 7.3 m in Soma. It

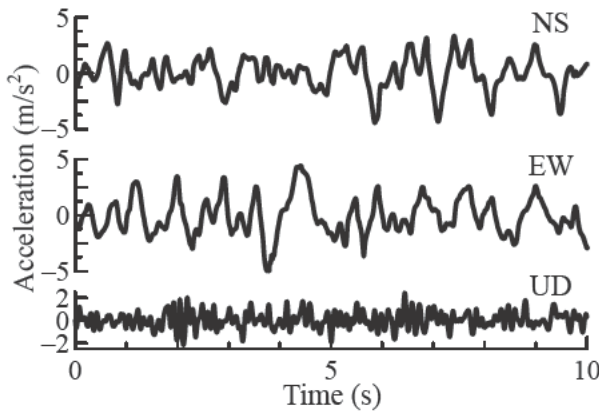

(a) Accelerations during 10 s around the peak values

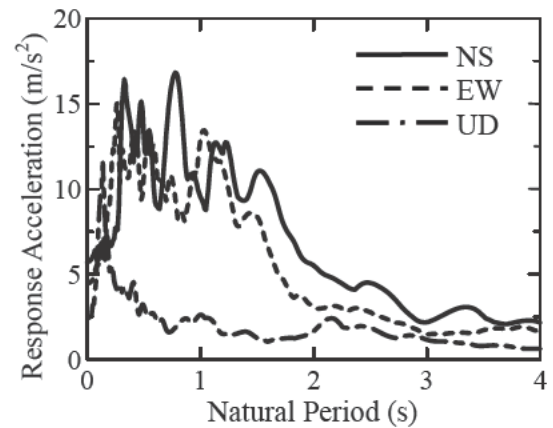

(b) Response accelerations

Fig. 3 Acceleration record at Furukawa, Osaki City (K-NET)

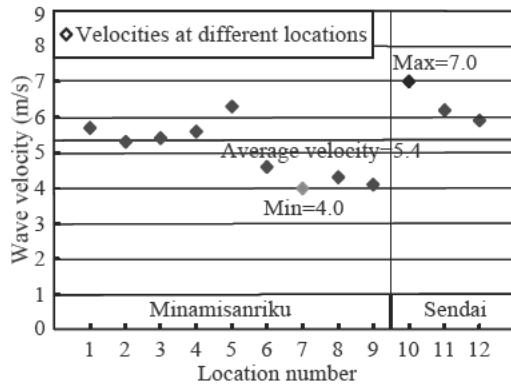

Fig. 4 Estimated tsunami particle velocity

is estimated that real tsunami height was as high as 15m at Onagawa fishery port.

For evaluating tsunami actions to bridges, it is important to know tsunami flow velocity. For this purpose, 12 videos which recorded tsunami flow in Minami-Sanriku Town and Sendai City were analyzed. Particle velocity was estimated based on the time required for a piece of debris to flow between two distinguished points. The distance between the two points and the time were measured using Google Earth's distance measurer and the video's timer, respectively.

Fig. 4 shows tsunami particle velocities evaluated at 12 locations. The maximum, average and the minimum tsunami particle velocities were 7.0m/s, 5.4m/s and 4.0m/s, respectively.



Photo 1 Shear failure of a column due to termination of longitudinal bars with insufficient development (Fuji Bridge) (courtesy of Dr. Hoshikuma, J., PWRI)

3. GROUND MOTION INDUCE DAMAGE OF ROAD BRIDGES

3.1 Damage of Bridges which were not yet Retrofitted

Ground motion induced damage of road bridges was generally less significant. However extensive damage occurred at the bridges which were designed according to the pre-1990 design codes (JRA 1990) and were not yet retrofitted in accordance with the post-1990 design codes. For example, Photo 1 shows shear failure of a reinforced concrete column resulted from insufficient development at cut-off of longitudinal bars. This mode of damage occurred



Photo 2 Yuriage Bridge



Photo 3 Damage of pin and roller bearings

extensively in the 1995 Kobe, Japan earthquake [Kawashima and Unjoh 2007]. Extensive investigation was directed to clarify the failure mechanism of such columns [for example, Kawashima, Unjoh and Hoshikuma 2005], including a project consisting of series of large scale shake table experiments using E-Defense [Kawashima et al 1999]. Over 30,000 columns were so far retrofitted since 1995 Kobe earthquake. Consequently, during this earthquake, damage due to this mechanism was not predominant in the bridges which were retrofitted, but damage occurred at the bridges which were not yet appropriately retrofitted.

Yuriage Bridge as shown in Photo 2 suffered extensive damage at reinforced concrete hollow and solid columns, supports of prestressed concrete girders, and steel pin and roller bearings during 1978 Miyagi-ken-oki earthquake. Since the damaged columns were repaired and strengthened by reinforced concrete jacketing, they did not suffer damage this time. However pin and roller bearings suffered damage again in



Photo 4 Damage of PC girders near the support

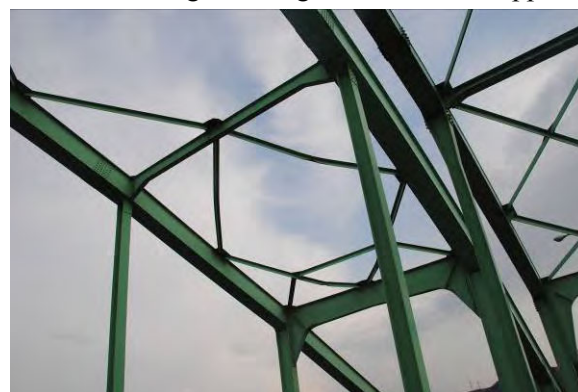

Photo 5 Buckled truss braces

the similar way as shown in Photo 3. It is obvious that pin and roller bearings are vulnerable to seismic action, because the stress builds up until failure by allowing virtually no relative displacement at pin bearings and relative displacement accommodated in roller bearings is insufficient to realistic relative displacement developed under a strong excitation.

Furthermore, the same supports of prestressed concrete girder which suffered damage in 1978 Miyagi-ken-oki earthquake suffered again as shown in Photo 4. Taking account of likely concentration of seismic force at this region and the importance of anchorage of PC cables, more rigorous repair had have to be conducted after 1978 Miyagi-ken-oki earthquake.



Photo 6 Damage of a pier during 1978 Miyagi-ken-oki earthquake (Sendai Bridge)



Photo 7 Retrofitted pier of Sendai Bridge which did not suffer damage during 2011 Great East Japan earthquake

Tennoh Bridge built in 1959 suffered extensive damage during 1978 Miyagi-ken-oki earthquake. This bridge suffered extensive damage again during this earthquake at the same members; truss braces and pin and roller bearings as shown in Photo 5.

On the other hand, damage of bridges which were already retrofitted suffered virtually no damage. For example, Sendai Bridge which is a symbolic bridge in Sendai suffered extensive damage at columns and bearings as shown in Photo 6 during 1978 Miyagi-ken-oki earthquake. However this bridge suffered no damage during this earthquake, because columns were retrofitted as shown in Photo 7 and steel bearings were replaced with elastomeric bearings.

3.2 New Bridges Constructed by Post-1990 Codes

Since 1990, the seismic design code was extensively upgraded [JRA 1990]. Before 1990, only elastic static and dynamic analysis was used assuming unrealistically small seismic design force. However after 1990, inelastic static and dynamic analyses based on Type I/Level 2 design ground motions (middle-field ground motions by M8 events) and an evaluation method of inertia forces considering multi-span continuous effect were introduced, and introduction of those provisions much enhanced the ductility capacity of columns and the seismic performance of bridges. Furthermore in the 1996 code [JRA 1996, Kawashima 2000] which was revised taking account of damage experience of 1995 Kobe earthquake, the Type II/ Level 2 design ground motions (near-field ground motions by M7 events), seismic isolation and use of elastomeric bearings were incorporated. Furthermore, strength of unseating prevention devices was enhanced.

As a consequence of the upgrading of seismic measures, damage of bridges which were built or were retrofitted in accordance with the post-1990 design codes suffered essentially no damage during this earthquake.

For example, Photo 8 shows Shin-Tenno Bridge which was constructed in 2002 suffered no damage. This bridge was located 150 m upstream of Tenno Bridge which suffered damage during 1978 Miyagi-ken-oki earthquake and suffered damage again at almost the same components. Photo 9 shows an end of girder at the left bank where it was supported by elastomeric bearings. New cable restrainers which satisfy the requirements by the post-1990 design code are set. No damage occurred in this bridge.

Elastomeric bearings including lead rubber bearings and high damping rubber bearings performed much better than vulnerable steel bearings. However it should be noticed that elastomeric bearings ruptured in several bridges. For example, at Sendai-Tobu viaduct as shown in Photo 10, several elastomeric bearings ruptured



Photo 8 Shin-Tenno Bridge



Photo 9 An end of deck supported by elastomeric bearings and unseating prevention devices

such that the deck offset in the transverse direction and settled aside the ruptured bearings as shown in Photo 11. Rubber layers detached from steel plates as well as rupture inside rubber layers as shown in Photo 12. Since extensive number of elastomeric bearings including high damping rubber bearings and lead rubber bearings are used, the damage should be critically investigated. It is pointed out that one of the possible reasons for the damage is that the interaction between adjacent bridges with different natural periods was not properly considered in design of elastomeric bearings. Since an expansion joint constrained relative displacement between adjacent decks in the transverse direction, it is likely that larger displacement demand of an adjacent deck is imposed to the elastomeric bearings which were designed based on smaller displacement demand [Quan and Kawashima 2009].



Photo 10 Piers where elastomeric bearings ruptured (Sendai-Tobu viaduct)



Photo 11 Transverse offset of a girder due to rupture of elastomeric bearings



Photo 12 One of elastomeric bearings ruptured

4. GROUND MOTION INDUCED DAMAGE OF SHINKANSEN VIADUCTS

4.1 Seismic Retrofit Program of Shinkansen

Tohoku Shinkansen started the service in 1982 between Omiya and Morioka Stations. Since Shinkansen viaducts were designed prior to the

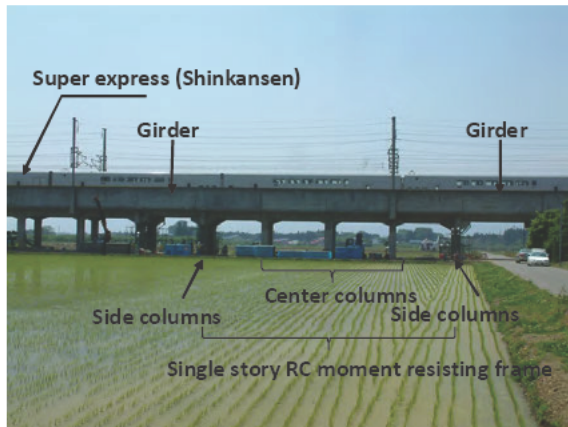

Photo 13 Single story RC moment resisting frame pier with a Gerber girder at both sides



Photo 14 Shear failure of RC columns at Odaki viaducts after 2003 Sanriku-Minami earthquake

occurrence of 1978 Miyagi-ken-oki earthquake, they have smaller amount of shear reinforcements than required by the current code. Some viaducts of Tohoku Shinkansen between Morioka and Mizusawa-Esashi stations in Iwate-ken were extensively damaged during 2003 Sanriku-Minami earthquake [JSCE 2004].

It should be noted that all viaducts which suffered damage during 2011 Great East Japan earthquake had not yet been retrofitted. Most viaducts in Iwate-ken were single story RC moment resisting frame with a Gerber girder at both sides. Damage concentrated at the side columns during 2003 Sanriku-Minami earthquake as shown in Photo 13. Since the side columns were shorter than the center column, a parameter α defined as a ratio of the shear capacity to the flexural capacity was smaller in the side columns than the center columns, which



Photo 15 No. 3 Odaki viaducts which were retrofitted after 2003 Sanriku-Minami earthquake performed well during 2011 Great East Japan earthquake

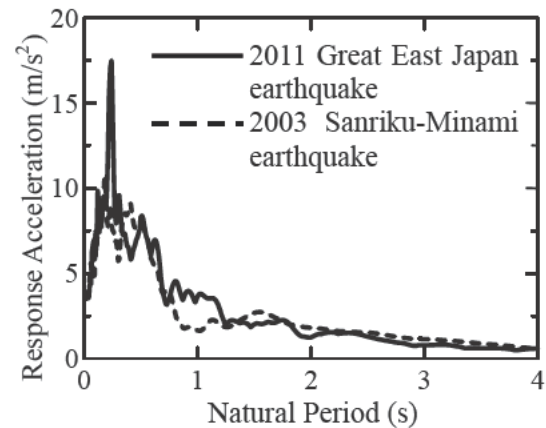

Fig. 5 Response accelerations in 2003 Sanriku-Minami earthquake and 2011 Great East Japan earthquake



Photo 16 Damage of R7 column, No. 1 Nakasone viaduct during 2011 Great East Japan earthquake



Photo 17 Close view of damage of R7-1 and R7-2 columns

led shear failure in the side columns.

After 2004 Niigata-ken Chuetsu earthquake [Huyck et al 2006], the first seismic retrofit program was initiated for Shinkan-sen viaducts including Tohoku Shinkansen. Objectives of the program were to enhance the seismic performance of the columns with insufficient shear capacity. After retrofitting 12,500 columns, the program was completed by 2007. In 2009, the second retrofit program for enhancing columns flexural capacity was initiated.

4.2 No. 3 Odaki Viaducts

No. 3 Odaki viaducts in Iwate-ken failed in shear as shown in Photo 14 during 2003 Sanriku-Minami earthquake. The viaducts were retrofitted so that they had sufficient shear capacity under the first retrofit program after 2004 Niigata-ken Chuetsu earthquake. The retrofitted columns of the viaducts performed well with almost no damage during 2011 Great East Japan earthquake as shown in Photo 15.

Fig. 5 compares the 5% damping response accelerations between 2003 Sanriku-Minami earthquake and 2011 Great East Japan earthquake. The records were measured at approximately 3km from No. 3 Odaki viaducts. Since the fundamental natural period of a single story RC rigid frame ranges between 0.4s to 0.6s,

it is reasonable to considered that the response acceleration of No. 3 Odaki viaducts was nearly the same between 2003 Sanriku-Minami earthquake and 2011 Great East Japan earthquake. It is considered that the seismic retrofit for No. 3 Odaki viaducts was effective for preventing significant damage during this earthquake.

4.3 No. 1 Nakasone Viaducts

No. 1 Nakasone Viaducts, constructed in 1978, is located between Kitakami and Shin-Hanamaki Stations. They had the similar structural shape with the No. 3 Odaki viaducts. No columns were retrofitted during the first seismic retrofit program since it was evaluated that the parameter α was not small enough.

During 2011 Great East Japan earthquake, side columns suffered extensive damage as shown in Photo 16. All columns lost even the bearing capacity for vertical load. It was fortunate enough not to totally collapse because the viaduct was supported by eight columns. Side columns in other viaducts also suffered extensive damage. Shear failure occurred at the upper part of columns as shown in Photo 17. The damage was so extensive that original shear cracks could not be identified because of crash and spill out of the core concrete.

Table 1 Numbers of bridges which were washed away by tsunami

Types of bridges	Number of bridges washed away
Railways	101
National roads	9
Prefectural roads	14
City or town roads	More than 200
Total	324



Photo 18 Damage of Utatsu Bridge

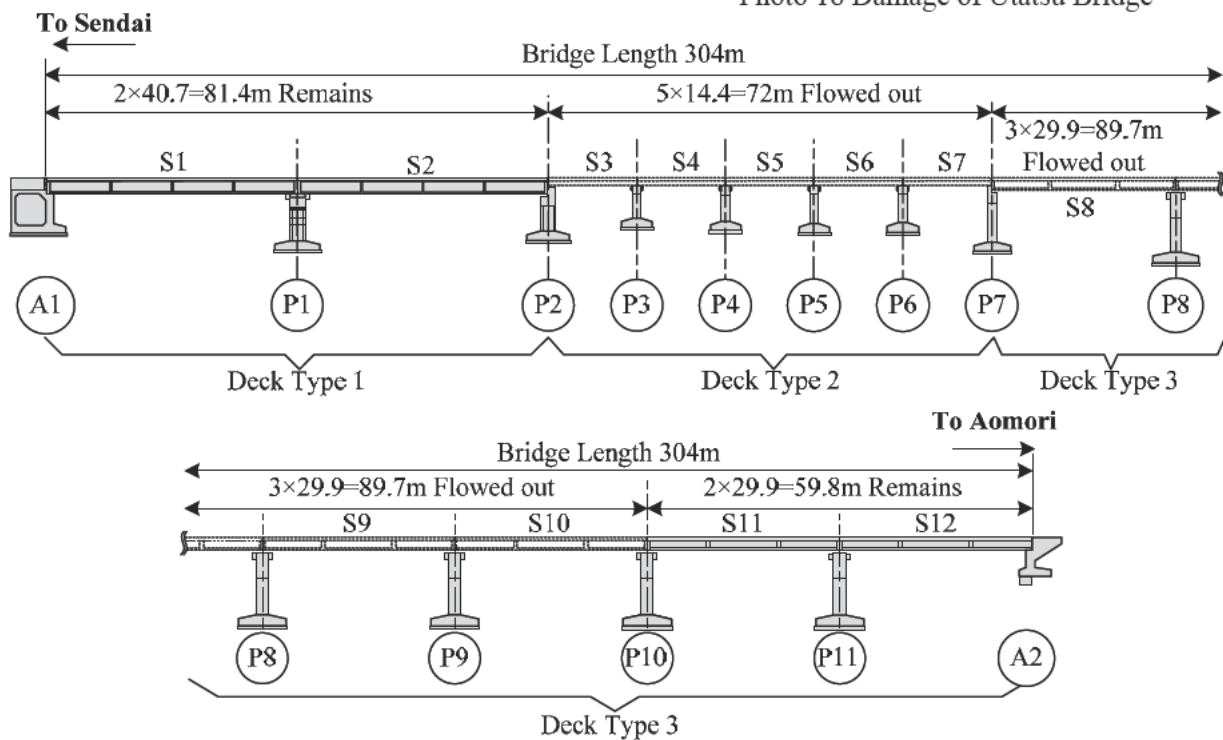

Fig. 6 Utatsu bridge

In the JR seismic evaluation, it was evaluated that shear failure occurred if the parameter α was smaller than 0.9. From the fact that the columns in No. 1 Nakasone viaducts failed in shear although α was not as small as 0.9, it is recommended to revise the criteria of failure mode in the future seismic retrofit program.

5. TSUNAMI INDUCED DAMAGE OF BRIDGES

5.1 Typical Damage to Road Bridges

More than 300 bridges were washed away by the

tsunami. Jurisdiction of the bridges which were washed away by tsunami can be classified as shown in Table 1. A large number of bridges which suffered damage were either on railways or regional roads. Smaller and shorter span bridges which were built in the early days were vulnerable to tsunami effect. It was generally seen that either tall bridges or short bridges did not suffer damage by tsunami because tsunami front did not reach the bridges or over passed. The bridges with mi-range height suffered extensive damage because debris or ships directly attacked decks [JSCE 2011].

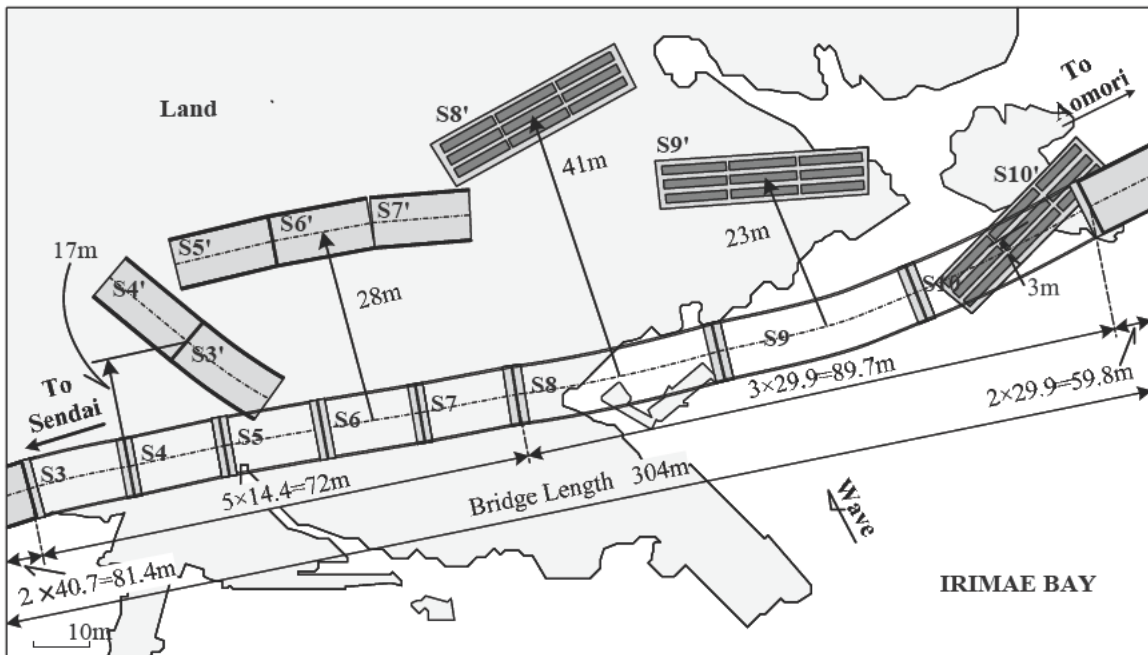

Fig. 7 Outflow of superstructure



Photo 19 Effective restrainers to tie together adjacent decks

Utatsu Bridge at Minami-sanriku Town over Irimae Bay suffered extensive damage by tsunami as shown in Photo 18. It consisted of 3 types of superstructures with spans ranging from 14.4m to 40.7m, as shown in Fig. 6. The superstructures from S3 to S10 were completely washed away from their supports in the transverse direction due to tsunami while the superstructures S1, S2, S11 and S12 were not



Photo 20 An overturned superstructure

washed away. The outflow displacements of S3~S10 are shown in Fig. 7. It should be noted that the spans located at the center such as S5-S7 and S8 were flowed 28 m and 41 m away from the original position, while the spans located at the sides such as S1, S2, S11 and S12 were not washed away. It is noted that S3, S4 and S4, and S5, S6 and S7 which flowed out together because they were tied by cable restrainers for preventing excessive superstructure response under a large seismic excitation as shown in Photo 19. S8, S9 and S10 overturned during being floated as shown in Photo 20.

Photo 21 shows the top of a pier after



Photo 21 Steel devices for extending seat length (short device) and steel stoppers for preventing excessive longitudinal deck response due to ground motions (tall device)

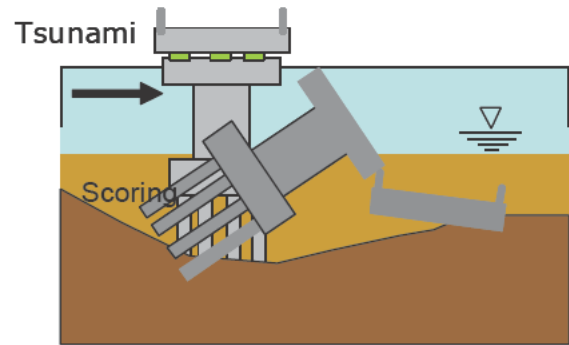

Photo 22 Failure of a RC side stopper, and four steel stoppers for preventing excessive longitudinal deck response which were not damaged

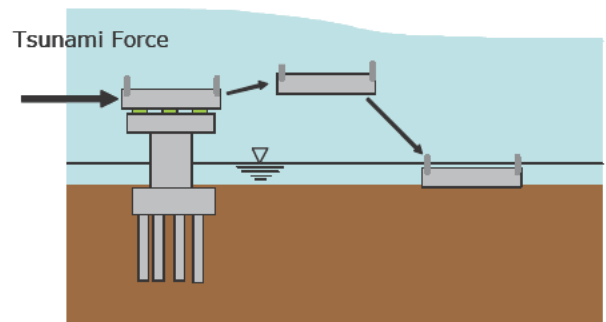

Photo 23 An upper steel bearing after damaged

superstructures were washed away. Two types of steel devices were set as an unseating prevention device in this column; one is the devices aiming of increasing seat length required by the recent code, and the other is the devices which were set



(a) Scoring



(b) Transverse offset

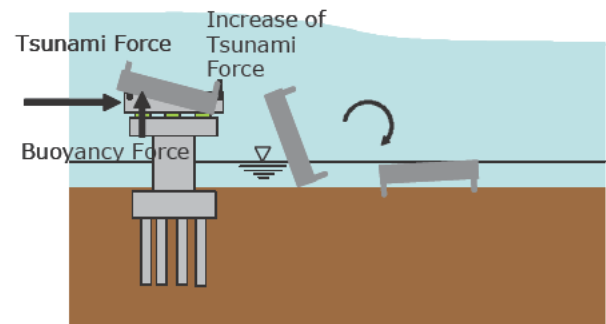

(c) Offset after overturning

Fig. 8 Possible mechanism of bridge damage by tsunami

for preventing excessive deck displacement in the longitudinal direction. It is important to know that none of those devices tilted or were detached from the pier which must have happened if the decks were simply washed away laterally. It is likely that the decks were uplifted by tsunami buoyancy force and then they were washed away. Steel plate bearings used in this bridge was very simple as shown in Photo 22 such that both uplift and lateral force capacities were limited.

This is also the case at a column shown in Photo 23 in which four stoppers did not tilt. But a RC side stopper at the land side collapsed probably

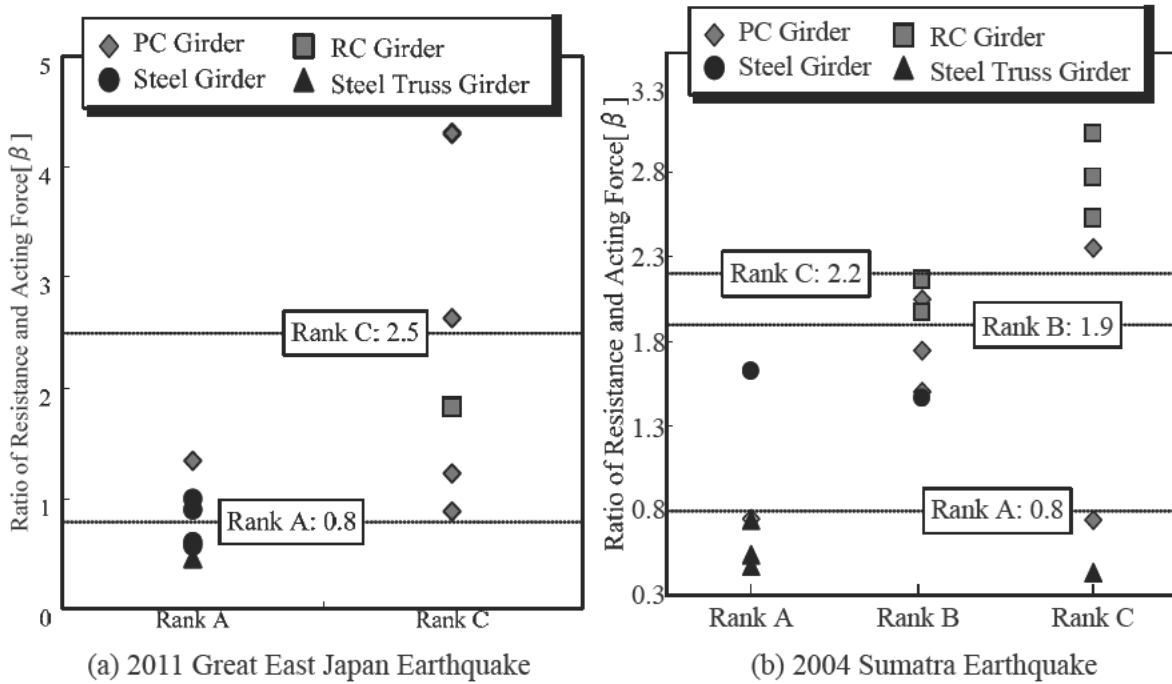

Fig. 9 Correlation of β value with damage ranks

due to a transverse force which applied from the deck. It is likely that due to tsunami force the deck uplifted at the sea side first being supported only at the land side, which resulted in larger tsunami force. Thus the side stopper at the land side collapsed due to excessive concentration of tsunami force.

Fig. 8 shows possible mechanism of damage of bridges due to tsunami. As mentioned earlier, overturning of foundation due to scouring did not occur in road bridges. It is likely that damage of decks in Photos 20 and 21 occurred due to mechanism shown in Fig. 8 (b) and (c), respectively.

In spite of the extensive damage of superstructures, none of piers suffered damage due to tsunami at Utatsu bridge.

5.2 An Evaluation of Tsunami Induced Damage

A preliminary analysis was conducted to evaluate tsunami induced damage of bridges by assuming that superstructures were simply laterally washed away without uplift. A parameter β was defined as [Kosa et al 2010]

$$\beta = \frac{S}{F} \tag{1}$$

in which F is tsunami force and S is the lateral capacity of a superstructure.

F and S were evaluated assuming that the lateral capacity of a superstructure in the transverse direction S can be evaluated by a friction force between a superstructure and a pier and that tsunami force F can be evaluated as a fluid force as [Kosa et al 2010]

$$F = \frac{1}{2} \rho_w C_d v^2 A \tag{2}$$

$$S = \mu W \tag{3}$$

in which ρ_w is mass density of fluid, C_d is the fluid water force coefficient, v is tsunami wave velocity, A is side area of a superstructure where tsunami force applies, μ is the friction coefficient, and W is dead weight of a superstructure. C_d was determined according to the Japanese specification [JRA 2002] and v was assumed as 6.0 m/s based on estimated

tsunami particle velocity at Utatsu Bridge. The frictional coefficient μ was assumed as 0.6 based on experiment [Shoji et al 2009].

Damage degree was defined Rank A; wash away of a superstructure, Rank B; some residual drift of a superstructure and Rank C; no movement of a superstructure.

Fig. 9 shows correlation of the parameter β with damage degree for 13 bridges. For comparison, β values evaluated for bridges during 2004 Sumatra Island earthquake are also shown here [Kosa et al 2010]. A correlation existed between the β value and damage degree for Indonesian bridges, with the mean β value of 0.8 for Rank A damage, 1.9 for Rank B damage, and 2.2 for Rank C damage. Consequently, there existed 2.5 times difference in β values between Ranks A and Rank C damage.

On the other hand, for 13 bridges, the mean β values was 0.8 for Rank A damage and 2.5 for Rank C damage during 2011 Great East Japan earthquake, though the latter had a relatively large scattering in the β value. The difference of β values between Ranks A and C damage was about 3.

6. CONCLUSIONS

Damage of road and railway bridges during 2011 Great East Japan earthquake was presented. Although more through collection of damage information as well as careful analyses is required, the following conclusions may be tentatively deduced based on the findings presented herein:

1) Ground motion induced damage of bridges which were built in accordance with the post-1990 design code was minor. Thus the effect of enhancing the shear and flexural capacity as well as ductility capacity, extensive implementation of elastomeric bearings and strengthening of unseating prevention devices were effective for mitigating damage during this earthquake. However, effectiveness of those measures against

much stronger near-field ground motions has to be carefully investigated since the ground motion induced by 2011 Great East Japan earthquake was smaller than anticipated target ground motions.

2) On the other hand, ground motion induced damage of bridges which were built in accordance with old code (approximately pre-1990) or which were not yet retrofitted was still extensive. This was in particular true for railway bridges. Appropriate seismic retrofit is required in the near future.

3) Tsunami induced damage was extensive to bridges along the Pacific coast. It seems that decks were uplifted and washed away upstream. Tsunami force effect has to be studied more so that it can be considered in design for bridges along the coast.

ACKNOWLEDGEMENTS

The authors express their sincere appreciation for a number of organizations and persons for their kind support and cooperation for the field damage investigation. A joint investigation was conducted as a part of UJNR Panel on Wind and Seismic Effect activity. Special appreciation is extended to Dr. Yen, F., FHWA and Professor Buckle, I., University of Nevada, Reno, and members of National Institute of Land and Infrastructure and Public Works Research Institute including Drs. Tamura, K., Unjoh, S., and Hoshikuma, J. Support of Disaster Risk Management Committee, World Federation on Engineering Organizations is also acknowledged.

REFERENCES

- 1) Huyck, C. K., Matsuoka, M., Takahashi, Y., and Vu, T. T.: Reconnaissance technologies used after the 2004 Niigata-ken Chuetsu, Japan, Earthquake, Earthquake Spectra, Vol.22, No. S1, pp. S133-S146, 2006.
- 2) Iemura, H., Takahashi, Y., Pradono, M. H., Sukamdo, P., and Kurniawan, R.: Earthquake and tsunami questionnaires in Banda Aceh and surrounding areas, Disaster Prevention and Management, Vol.15, No.1, pp.21-30, 2006.

- 3) Ishibashi, T, Ikeda, Y., Kanno, T. and Okamura, H.: The study on earthquake resistance on design and damage of reinforced concrete viaduct, *Journal of JSCE*, No.563/I-39, pp.95-103, 1997 (in Japanese).
- 4) Japan Road Association: Design specifications of highway bridges, Part V Seismic design, 1990.
- 5) Japan Road Association: Design specifications for highway bridges, Part I Common part I and Part V Seismic design, 2002.
- 6) Japan Society of Civil Engineers: Report on reconnaissance damage investigation to civil engineering facilities resulted from 2011 Great East Japan earthquake, 2011.
- 7) Japan Society of civil engineers: Damage analysis of concrete structures due to the earthquakes in 2003, *Concrete Library*, 114, 2004 (in Japanese).
- 8) Kawashima, K., Unjoh, S. and Hoshikuma, J.: A seismic evaluation method of RC bridge piers with inadequate anchoring length at termination of main reinforcements, *Journal of JSCE*, No. 525/I-33, pp. 83-95, 1995.
- 9) Kawashima, K., and Unjoh, S.: The damage of highway bridges in the 1995 Hyogo-ken-nanbu earthquake and its impact of Japanese seismic design, *Journal of Earthquake Engineering*, Vol. 1, No. 3, pp. 505-541, 1997.
- 10) Kawashima, K.: Seismic design and retrofit of bridges, Key note presentation, 12th World Conference on Earthquake Engineering, pp. 1-20, Paper No. 1818, Auckland, New Zealand, 2000.
- 11) Kawashima, K., Sasaki, T., Kajiwara, K., Ukon, H., Unjoh, S., Sakai, J., Kosa, K., Takahashi, Y., Yabe, M. and Matsuzaki, H.: Shake table experiment on RC bridge columns using E-Defense, Proc. 41st Panel on Wind and Seismic Effects, UJNR, Public Works Research Institute, Tsukuba Science City, Japan, 2009.
- 12) Kosa, K, Nii, S., Shoji G., Miyahara K.: Analysis of Damaged Bridge by Tsunami due to Sumatra Earthquake, *Journal of Structural Engineering*, Vol.56A, JSCE, pp. 454-463, 2010.
- 13) Quan, G. and Kawashima, K.: Effect of finger expansion joints on the seismic response of bridges, *Journal of JSCE, A*, Vol. 65, No. 1, pp. 243-254, 2009 (in Japanese).
- 14) Shoji, G., Moriyama, T., Fujima K., Shigihara Y., and Kasahara, K.: Experimental study associated with a breaking tsunami wave load acting onto a single span bridge deck, *Journal of Structural Engineering*, Vol. 55A, pp. 460-470, JSCE, 2009.

Port Damage from Tsunami of the Great East Japan Earthquake

by

Takashi Tomita¹, Gyeong-Seon Yeom², Daisuke Tatsumi², Osamu Okamoto³ and Hiroyasu Kawai⁴

ABSTRACT

This paper presents tsunami damage in ports caused by a tsunami of the Great East Japan Earthquake. The tsunami higher than tsunamis for plan and design of tsunami disaster mitigation structures such as tsunami breakwaters, seawalls and etc. caused destruction in some structures. Furthermore, the tsunami higher than the expected tsunamis for tsunami disaster mitigation plan in communities overflowed the tsunami disaster mitigation structures, and therefore caused devastating inundation in the communities. The tsunami whose inundation was deep on land changed big vessels and oil tanks into tsunami debris.

KEYWORDS: Debris, Destruction of Structure, Disaster, Great East Japan Earthquake, Inundation, Human Loss, Tsunami

1. INTRODUCTION

Japan has suffered many tsunami disaster experiences such as the 1896 Meiji Sanriku Tsunami in which 22,000 dead is reported. Even after improvement of coastal defense which has been implemented significantly since the 1960s, the 1983 Nihon-kai Chubu earthquake tsunami (Japan Sea tsunami) and 1993 Hokkaido Nansei-oki earthquake tsunami (Okushiri tsunami) caused 104 (100 persons were killed directly by the tsunami) and 230 dead and missing, respectively. In the Okushiri tsunami, since residents in Okushiri Island had a disaster experience of the 1983 Japan Sea tsunami that the southern part of the island was inundated and two persons were killed, many residents escaped to hills after an earthquake shock in 1993 and saved their lives. However, the tsunami came soon after the quake: for example, tsunami arrival time was 3 minutes in the northern part of the island near the epicenter. Some residents, therefore, did not have enough time for

evacuation. Furthermore two anglers were dead and missing in the mouth of a river by the 2003 Tokachi-oki earthquake tsunami. Since then no tsunamis have caused dead or missing.

However, a tsunami higher than the 1896 Meiji Sanriku Tsunami was generated by the 2011 off the Pacific coast of Tohoku Earthquake of Mw 9.0 at 14:46 JST on 11 March 2011, which occurred in a subduction zone where the Pacific plate subducts beneath the North American plate (or the Okhotsk plate). The tsunami caused devastating disasters in the northern part of main island of Japan. According to the National Police Agency, as of 27 August, the confirmed death is 15,735 persons and the missing is 4,467, the number of completely-damaged houses is 115,380. Further, 84,537 people were in 1,328 refuges as of 13 June, according to NPA. The Fishery Agency reported the number of damaged fishing boats is 25,008 as of 23 August.

2. OFFSHORE MEASUREMENT OF TSUNAMI

Buoys with a GPS sensor which have been installed offshore a coast in the Tohoku region [1] measured the tsunami propagating in the Pacific Ocean [2]. Figure 1 indicates a tsunami profile measured off Kamaishi Port as an example. Although the water depth is 204 m at the measurement point, the maximum tsunami height is 6.5 m. This high tsunami in the offshore region is enlarged due to wave transformation in shallower water depth region. The tsunami 0.5 m high was still measured 6 hours later after the

¹ Research Director, Asia-Pacific Center for Coastal Disaster Research, Port and Airport Research Institute, 3-1-1 Nagase, Yokosuka, 239-0826 Japan

² Researcher, ditto

³ Senior Researcher, ditto

⁴ Director of Marine Information Field, ditto

This report was written with some new additions into an original paper submitted to the Proceedings of the 21st International Offshore and Polar Engineering Conference.

earthquake shock. Uplift 0.55 m of the mean water level after the quake may indicate subsidence of land where a reference point was set to improve accuracy of vertical measurement with GPS.

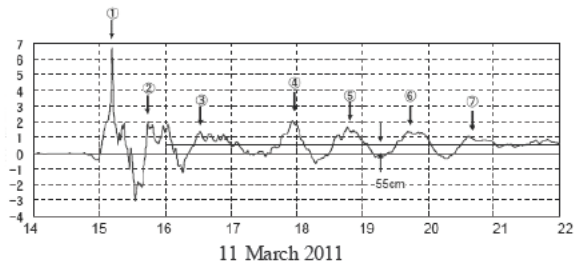

Fig. 1 Tsunami measured with GPS Buoy off Kamaishi Port.

3. TSUNAMI TRACE HEIGHTS

Since April many teams have conducted field surveys to measure heights of tsunami trace and understand tsunami damage. Useful and valuable data on tsunami inundation and runup heights at more than 5,000 points are summarized in a web page of the 2011 Tohoku Earthquake Tsunami Joint Survey Group (<http://www.coastal.jp/ttjt/>).

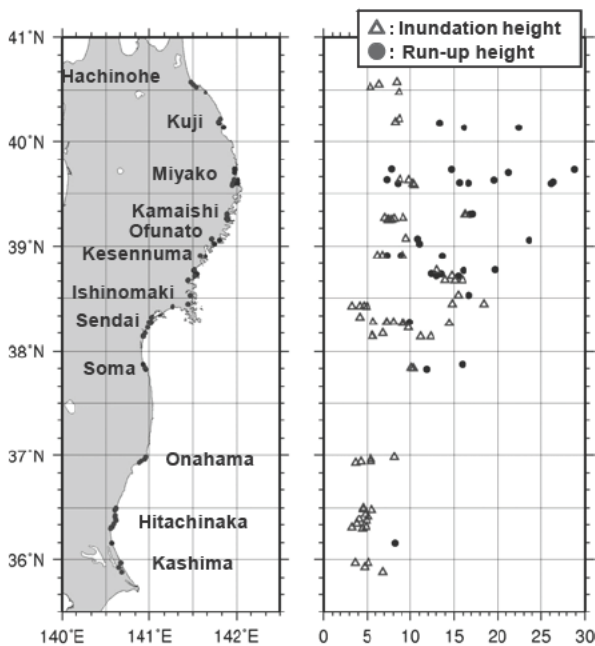

Fig. 2 Tsunami trace heights measured in major ports

Figure 2 indicates heights of tsunami trace measured by teams dispatched to major devastated ports by the Port and Airport Research Institute [3~5]. In the figure, (I) and (R) indicate inundation height and runup height, respectively. These values are height above the estimated tide level at the time of tsunami arrival.

In the Sanriku coast from Kuji to Kesennuma, which is a ria coast, tsunami inundation height is higher than those of Hachinohe and southern part from Ishinomaki. However, the tsunamis striking coasts of Ishinomaki and Sendai are more than 10 m high, and those of Soma and Onahama are still more than 5 m, which are higher than the expected tsunami heights for tsunami disaster mitigation plans in those areas.

4. TSUNAMI DAMAGE

According to the survey in Hachinohe Port [2], even at points protected by breakwaters inundation heights are 5.4 to 6.4 m. They are 2.5 to 2.9 m in terms of inundation depth above the ground surface. Since the inundation depth is deep enough to float fishing boats, some boats are landed as shown in Figure 3. On the other hand, at the points directly facing the Pacific Ocean, inundation heights are 8.3 to 8.4 m. The breakwaters may have effect of tsunami reduction in the protected area. Even in the outside of breakwater, inundation height is 6.0 m behind a coastal green belt consisting of pine trees. Although additional surveys are needed to determine direction of tsunami flooding at this point, the green belt may reduce tsunami flooding and actually prevents the fishing boats from hitting houses as shown in Figure 4.



Fig. 3 Landed boats



Fig. 4 Boats trapped by a coastal green belt

North breakwater caissons of 1,870 m out of the total length of 3,500 m were slipped out and submerged, being affected by tsunami, as shown in Figure 5. In the figure many caissons connecting to a caisson in the right side of the figure are submerged and parts of wave-absorbing blocks installed in front of caissons can be seen above the sea surface. Significant seabed scours were measured around a corner of a reclaimed island quay as well as at the mouths of the breakwaters.



Fig. 5 Damaged north breakwater in Hachinohe Port

In Kuji Port [2], the tsunami causing inundation depth of 4.4 m overtopped a line of tide protection wall of 3.6 m high, and flooded residential area. Furthermore, the tsunami causing 4.3 m inundation depth in the port area push oil tanks over sideways as shown in Figure 6. In Kesenuma, oil tanks became tsunami debris, which were landed on different places from the original positions.



Fig. 6 Damaged oil tanks in Kuji Port

In Kamaishi Port [4], the tsunami of 6.9 to 8.1 m in terms of inundation height floated and crushed wooden houses, as shown in Figure 7. Reinforced concrete (RC) buildings and large-scale grain silos were damaged but not collapsed. A number of vehicles together with destroyed houses were observed floated out on the road, as shown in Figure 8.



Fig. 7 Destruction of houses in Kamaishi



Fig. 8 Tsunami debris in Kamaishi

Offshore breakwater in Kamaishi Port was also damaged by the tsunami as shown in Figure 9. Caissons were slipped and submerged. Much difference in terms of water level between front and back of the breakwater may produce strong water pressure and fast current flowing in gaps between caissons to slide caissons [6].



Fig. 9 Damaged offshore breakwater in Kamaishi Port

In the Miyako bay including Miyako Port, almost same tsunami inundation heights were measured, as shown in Figure 10. The tsunami of 10 m overtopped a protection dike and inundated residential areas as shown in Figure 11. Vessels were landed on wharfs in the port. Logs and cars were also floated and impacted houses, as shown in Figure 12.



Fig. 10 Tsunami trace heights in Miyako Bay



Fig. 11 Destruction of residential area behind protection dike



Fig. 12 Debris impact

Tsunami debris are not only vessels, automobiles, oil tanks, logs but also shipping containers. In the Sendai-Shiogama port, many containers were scattered by the tsunami impact, as shown in Figure 13. In the Hachinohe port, many containers were taken away the sea.



Fig. 13 Scattered shipping containers in Sendai-Shiogama Port

4. TSUNAMI LEVELS FOR DISASTER PREVENTION AND MITIGATION

From the devastating and cruel tsunami disaster on March 11, tsunami levels are being reconsidered for tsunami disaster mitigation. Before the disaster, the tsunami level for disaster mitigation plan in a community was set based on the highest tsunami among historical tsunamis that a number of reliable data were remained on runup and inundation. Further, the tsunami level for a plan and design of tsunami reduction facilities such as a tsunami breakwater and seawall was also set based on the tsunami level for disaster mitigation plan in a community and other considerations. However, the March 11 tsunami was higher than those tsunami levels. Therefore, from now on, the maximum tsunami level in history of the area (Level-2 tsunami) is being considered to preserve human lives. Against this Level-2 tsunami, a community plan, evacuation plan and system should be integrated as well as structures to reduce tsunamis. However, it may be hard to construct the structures against such a high tsunami. Therefore, the Level-1 tsunami is also being considered. No damage is expected in a community against the Level-1 tsunami. Thus, structures prevent the tsunami of Level-1 or smaller to inundating the community.

5. CONCLUDING REMARKS

Tsunami-resilient communities should be built through integration of town/city planning, public education including evacuation drill, tsunami disaster mitigation structures, warning system and evacuation system including arrangement of emergency shelters.

Regarding tsunami reduction structures, such as breakwaters and seawall, they should have a function that prevents lives and properties from being lost by the level-1 tsunami or smaller. Even for a tsunami higher than the level-1

tsunami, their damage should be as little as possible. If damaged, it should be easily repaired. It is important to understand and explain to the public that the level-2 tsunami can overflow tsunami reduction structures and cause damage in the community.

6. REFERENCES

1. T Nagai, T., Satomi, S., Terada, Y., Kato, T., Nukada, K. and Kudaka, M.: GPS Buoy and Seabed Installed Wave Gauge Application to Offshore Tsunami Observation, *Proc. 15th Int. Offshore Polar Eng. Conf.*, ISOPE, Seoul, pp. 292-299, 2006.
2. PARI: Tsunami Measurement Result with GPS Wave Meters, <http://www.pari.go.jp/files/items/3527/File/results.pdf> (in Japanese), 2011.
3. PARI: Preliminary Report of Urgent Field Survey in Hachinohe and Kuji Ports, <http://www.pari.go.jp/files/3523/1658995676.pdf> (in Japanese), 2011.
4. PARI: Preliminary Report of Urgent Field Survey in Kamaishi and Oofunato Ports, <http://www.pari.go.jp/files/3524/1287232102.pdf> (in Japanese), 2011.
5. PARI: Preliminary Report of Urgent Field Survey in Sendai and Ishinomaki Ports, <http://www.pari.go.jp/files/3525/696358192.pdf> (in Japanese), 2011.
6. PARI: Factors to Damage Offshore Breakwater in Kamaishi Port by the 2011 Japan Earthquake and Tsunami, <http://www.pari.go.jp/files/items/3544/File/20110401-3.pdf> (in Japanese), 2011.
7. Takahashi S. et al.: Urgent Survey for 2011 Great East Japan Earthquake and Tsunami Disaster in Ports and Coasts, *Tech. of Note PARI*, No. 1231, 2011.

ASCE/JSCE Tohoku Tsunami Investigation of Structural Damage and Development of the ASCE 7 Tsunami Design Code for Buildings and Other Structures

by
Gary Chock¹

ABSTRACT

ASCE has sponsored several reconnaissance teams to survey various effects of the Great East Japan Earthquake and Tohoku Tsunami. The first of these was the ASCE Tsunami Team, which traveled to Japan from April 15 to May 1 and focused on tsunami effects on coastal infrastructure including buildings, bridges, port facilities and coastal protective structures. Members of the team were from the ASCE7 subcommittee on Tsunami Loads and Effects. This committee was formed to draft a chapter on Tsunami Loads and Effects for inclusion in the 2016 edition of ASCE7, Minimum Design Loads for Buildings and Other Structures. The purpose of this ASCE tsunami reconnaissance trip has been to investigate and document the performance of buildings and other structures in Japan, with the specific intent to apply this experience in ongoing work to develop tsunami structural design provisions for the ASCE 7 Standard.

KEYWORDS: Tohoku Tsunami, Great East Japan Earthquake, ASCE, structural design

1. INTRODUCTION

The Tohoku Tsunami presented all loading and effects including:

Hydrostatic Forces: Buoyant forces, additional loads on elevated floors, unbalanced lateral forces

Hydrodynamic Forces: Lateral and uplift pressures of tsunami bore and surge flow

Debris Damming and Debris Impact Forces: External and internal debris accumulation and striking

Scour Effects: Shear of cyclic inflow and outflow, and transient liquefaction due to depressurization during outflow.

There is great interest in the United States in studying the effects of the Tohoku Tsunami, due to the analogous threat posed by the Cascadia

subduction zone to the Pacific Northwest of North America. In 1700 it is believed that this subduction zone generated a tsunamigenic earthquake estimated to be magnitude 9.

The ASCE Structural Engineering Institute has decided to incorporate tsunami design provisions in the national load standard, ASCE 7, and it dispatched the ASCE Tsunami Team led by the author to Japan a month after the Tohoku Tsunami of March 11, 2011. It was crucially important to capture contextual tsunami damage evidence quickly before they were cleared. Otherwise, it is much more difficult to recreate an understanding of the circumstances to which a particular structure was subjected. The ASCE Tsunami Reconnaissance Team conducted field surveys starting on April 16, which was the first day officially recommended by JSCE for international tsunami reconnaissance teams.

The Tohoku Earthquake Tsunami Joint Survey Group has published considerable online data of the peak inundation and runup heights, compiled from the work of over 100 Japanese researchers who were in the field for at least three weeks in late March and early April (clearinghouse at <http://www.coastal.jp/ttjt>). Therefore, the ASCE Tsunami Team concentrated on identifying structures of interest, the local tsunami inundation depth at the site, and researching the probable flow velocities either by video analysis or by analysis of clearly defined failure mechanisms of “flow surrogate” structural elements.

Having traveled throughout the area both within and outside the inundated areas, we noted that the *surviving* structures observed did not appear to have significant earthquake damage.

¹ Chair, ASCE 7 Tsunami Loads and Effects Subcommittee; and President, Martin & Chock, Inc. Structural Engineers
<gchock@martinchock.com>

Presently prepared for publication as a monograph, The ASCE Tsunami Reconnaissance Team report [1] covers the following investigative areas. In this paper, we concentrate on describing the estimation of flow velocities and evaluation of building performance.

1. Introduction
2. ASCE-JSCE-BRI Collaboration
3. Great East Japan Earthquake and Tohoku Tsunami
4. Pre-Survey Preparatory Research
5. Tsunami Warning and Evacuation
6. Tsunami Flow Velocities
7. Debris Loading
8. Building Structural Performance
9. Bridge Performance
10. Breakwaters
11. Seawalls and Tsunami Barriers
12. Piers, Quays and Wharves
13. Scour Effects
14. Other Structures
15. Initial Recovery Efforts
16. Failure Mode Analyses
17. Findings and Recommendations
18. Acknowledgements
19. Appendices
20. References

2. METHODS OF ANALYSIS

2.1 Flow velocities

2.1.1 The Tohoku tsunami provided an unprecedented opportunity to analyze tsunami flow conditions based on video and field evidence. Much of this analysis has been performed remotely using only the captured videos and satellite imagery tools such as Google Earth. However, field verification of dimensions provided valuable confirmation of the assumptions made during video analysis. Field investigation was also necessary to determine flow depth which is difficult to estimate from the video evidence alone.

2.1.2 Flow surrogates

If video evidence is not available at a location of interest, it is possible to estimate the flow characteristics by reverse analysis of a “flow

surrogate”. Figure 1 shows an example of a “flow surrogate” adjacent to a critical structural test case of a large-scale wall blowout in the Takada Matsubara building in Rikuzentakata.

Table 1: Summary of flow velocities determined from video evidence

Location	Wave form	Tracking object	Est. velocity (m/s)
Natori River	River bore	Leading edge of bore	6.89
Sendai Airport	Sheet flow surge	Leading edge of flow	3.75
Kamaishi	Surge	Leading edge of flow	3.75
	Surge	Debris in flow	5.17
Kessenuma	Surge	Debris in flow between buildings	4.74 – 5.0
Onagawa	Initial sheet flow surge	Sheet flow over port streets	2.92
	Inflow at 50% inundation	Debris in flow	3.91
	Outflow between Marine Pal Bldgs.	Debris in flow	7.43 – 8.19
Minamisanriku	Incoming river surge	Debris in flow	5 – 8.73
Noda Tamagawa	Harbor bore	Leading edge of bore	9.78
	Unbroken swell	Leading edge of swell	13.4
Kuji Port	Unbroken swell	Leading edge of swell	12.33

Two large light standards stood on either side of the building. The maximum inundation depth measured by debris on the building was less than

the elevation of the light fixture on top of the pole. Based on structural analysis, the pushover of the light standards during the 10 meter deep inflow had following sequence. Under flexural bending, an initial buckling of the thin pipe walls above the base plate stiffeners resulted in rotation of the pipe until the initially dry light fixture frame at the top of the pole was lowered into the flow and captured debris. This debris load at the top of the pole greatly increased the moment at the base and initiated much more rotation until it generated tensile rupture of the anchor bolts. A depth-averaged flow velocity of at least 7.25 m/s was determined from structural analysis of the pole in order to create the initial buckling. The bolt anchorage group had higher moment capacity than the flexural local buckling strength of the pole. In the same vicinity, the undamaged railings of a bridge were analyzed to provide an upper bound for the flow velocity of 7-3/4 m/s at this location. Thus, at this location we have estimates that bracket the estimated flow velocity to be greater than 7-1/4 m/s but less than 7-3/4 m/s.



Figure 1 Takada Matsubara Building

2.1.3 Range of velocities determined

Utilizing both video and “flow surrogate” analysis, we have been able to ascertain flow velocities at numerous sites of interest. The characteristic tsunami flow velocities resulting in damage to engineered structures typically range from 5 to 8 m/s. However, there is evidence that flow velocities reached up to 10 m/s in areas of concentrated or accelerated flow.

2.2 Failure Analysis due to Fluid Forces

The ASCE Tsunami Reconnaissance Team selected a number of representative cases for failure mode analysis. In this section, cases studies of hydrostatic and hydrodynamic loading are further evaluated.

Yuriage Fish Market Concrete Wall Failures during Inflow

A large morning fish market building was located directly at the wharf area at the harbor of Yuriage. The building consisted of a large 120 m long by 20 m wide steel-truss framed single story high-bay building with a smaller attached one-story single bay of reinforced concrete bearing walls and concrete roof slab. The steel-framed main building was stripped off. A reinforced concrete utility closet for equipment had its sole door opening oriented towards the incoming tsunami, and was thus subjected to the internal pressure resulting from stagnation of the flow. Reinforcing bar samples tested to be equivalent to JIS G3112 SD 390 with 400 MPa average yield strength. In order for the failures shown here to have occurred, flow velocity would have been at least 7-1/2 meters/second.



Figure 2: Wall corner joint and flexural failure by internal hydrodynamic pressurization

Onagawa Two-Story Cold Storage Building Uplift

The building shown in Figure 3 was lifted by hydrostatic buoyancy off of its pile foundation, which did not have tensile capacity, and carried over a low wall before being deposited about 15 meters inland from its original location. This building was approximately 22 meters by 8.7 meters by 12 meters tall. Total deadweight of the structure was 8995 kN. The refrigerated space on the ground floor was effectively sealed off from being rapidly inundated with water, leading to a neutrally buoyant condition as soon as the water inundation depth reached 7 meters. The building was lifted off its original site and carried just barely over a short wall (background of photograph on the left), and then was apparently flipped over by contact with the top of the wall that it damaged in the process. Once sideways, the buoyant displaced volume was reduced from when it was upright.



Figure 3 The ASCE Tohoku Tsunami Reconnaissance Team at the Onagawa uplifted and overturned 2-story reinforced concrete cold-storage building - Note low wall with top edge spalled (Hideyuki Kasano)

Onagawa Three-Story Steel Building Pushover in Return Flow

The three-story steel moment-resisting frame in Figure 3 was exposed to flow returning to the ocean which has been estimated from video analysis at about 8 m/s. The beams were stronger than the columns, since our inspection did not indicate any beam damage. With about 67% blockage of the original enclosure, (33% open), the return flow is sufficient to yield the

top and bottom of the second story column but not the third floor columns, nor the second and third story of the exterior columns. At the first yield point of the system, the calculated lateral drift at the third floor would be about 30 cm (and at the second floor it would be about 7 cm). Subsequently sustained flow induced further displacement until loss of all cladding reduced the building's projected area. A subsequent LiDAR scan of the frame shows a third floor drift of up to 50 cm. Without such load shedding, collapse would have occurred.



Figure 4 Onagawa 3-Story Steel Frame Pushover

Minami Gamou Wastewater Treatment Plant

Video of this facility in Sendai showed a soliton bore directly striking the longitudinal walls of buildings at this wastewater treatment plant sited at the shoreline. (Figure 5) Also, structural drawings for the damaged buildings were obtained from the plant management.

Based on loading calculated from the height of bore using the method of Robertson, Paczkowski, and Riggs [2], the bore forces were found to be sufficient to create the midheight and top and bottom flexural yielding. The bore impact forces were also found to exceed the surge and

hydrostatic forces resulting from the rising tsunami surge. It is preliminarily concluded that repeated soliton bore impacts were likely to be responsible for the amount of deformation found in this wall and another building nearby.



Figure 5 Minami Gamou Wastewater Treatment Plant Building.

Rikuzentakata Tourist Center Concrete Wall Failure during Inflow

The Takada Matsubara Road Station in Rikuzentakata shown in Figure 1 endured a 10.5 meter tsunami inundation depth with flow of about 7-1/2 meters/second, but suffered a failure of its principal transverse shear wall due to unbalanced hydrostatic and hydrodynamic forces of the incoming tsunami. The wall was at the rear face of a three-sided concrete box with the opening in the fourth side being a main entrance into the building at the front. Reinforcing steel was sampled and tested at 510 MPa average yield strength, consistent with JIS G3112 SD 490. The sequence of nonlinearities was found to be:

1. Flexural yielding of the base of the wall as soon as when the flow level reached 1.6 meters above grade.
2. Bottom half of side edge supports of the wall and the two ends of the horizontal beam yield when the flow level reached 2.2 meters.
3. The top and upper portions of the side supports of the wall yield and concrete shear cracks occur at the bottom when the flow reaches 2.7 meters. Shear friction of the double dowels from the

wall base foundation maintains stability of the bottom portion the wall.

4. Side supports and horizontal beam supports reach concrete shear failure cracking when the flow reaches 7.2 meters. The flexurally yielded wall essentially became a membrane pinned at the bottom.
5. The top and upper portions of the side supports reach concrete shear failure cracking when the flow reaches 9.5 meters. The top half of the wall is hanging in tension from the top beam.
6. At 10.5 meters, the upper portion of the concrete walls hanging in tension drops down and relieves further loading increase; the unbalanced hydrostatic forces are relieved.

2.4 Comparison with Seismic Design

It is possible to compare tsunami loading to the ultimate inelastic structural capacity of buildings designed to present seismic codes in the USA and Japan [3]. During the Tohoku Tsunami, sustained hydrodynamic forces exceeded the minimum seismic design code forces for almost all structures. The Japanese seismic design code [4] generally results in greater lateral forces and stiffer systems for reinforced concrete and steel buildings than in the USA, so additional analytical comparisons are necessary, rather than directly extrapolating the performance of Japanese buildings to the USA. Seismic designs in the USA [5] utilize greater reduction of the elastic design force, and this may result in an impairment of capacity from earthquake damage prior to the arrival of the tsunami. However, seismic design does have a beneficial effect that increases with the height or size of the building. Larger scaled and taller buildings will be inherently less susceptible, provided adequate foundation anchorage for resistance to scour and uplift are present.

Structures of all material types can be subject to general and progressive collapse during tsunami. Figure 6 shows a comparison using a prototypical low-rise steel building of various heights.

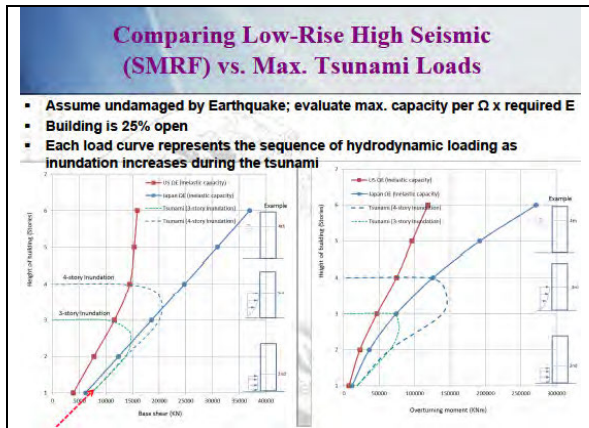

Figure 6

Figure 7 shows a comparison of a prototypical low-rise reinforced concrete building.

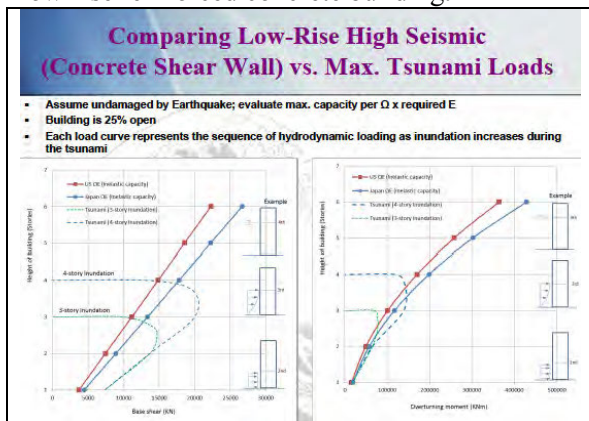

Figure 7

3. FURTHER DEVELOPMENT

3.1 Proposed Scope of the ASCE Tsunami Design Provisions in ASCE 7

It is presently anticipated that the new Chapter 6 - Tsunami Loads and Effects, will include the following code provisions:

- 6.1 General
- 6.2 Definitions
- 6.3 Symbols and Notation
- 6.4 Tsunami Design Criteria
- 6.5 Tsunami Depth and Velocity
- 6.6 Design Cases
- 6.7 Hydrostatic Loads
- 6.8 Hydrodynamic Loads
- 6.9 Waterborne Debris Loads
- 6.10 Foundation Design
- 6.11 Structural mitigation for reduced loading on buildings
- 6.12 Non - building critical facility

structures

6.13 Nonstructural Systems (Stairs, Life Safety MEP)

6.14 Site - Specific Analysis and Design Procedure Requirements

6.15 Special Occupancy Structures (such as vertical evacuation buildings)

3.2 Tsunami Design Performance Objectives

The provisions will have differing requirements based on the Risk Category of Building. Risk Categories are defined in ASCE 7 as:

Risk Category I: Buildings and other structures that represent a low risk to human life in the event of failure

Risk Category II: All buildings and other structures except those listed in Risk Categories I, III, and IV

Risk Category III: Buildings and other structures, not included in Risk Category IV, with potential to cause a substantial economic impact and/or mass disruption of day-to-day civilian life in the event of failure.

Risk Category IV: Buildings and other structures designated as essential facilities.

In Figure 8, the key performance levels are postulated for two return periods, the 100-year period for consistency with existing flood provisions, and a maximum considered 2500-year event consistent with existing seismic provisions. The design for the 2500-year event would be based on the inelastic range of structural behavior. The 500-year event is shown here for reference to the range of expected performance levels. “Light-Frame Residential” refers to single and two-family dwellings. Experience in storm surge and tsunamis has shown that this type of construction lacks the structural capability of surviving tsunami inundation of more than 3 to 4 meters depth, and so these buildings would be designed only for structural elevation above the 100-year tsunami inundation height, similar to existing requirements for coastal storm flooding.



Figure 8 Tsunami Performance Design Objectives

4. LESSONS FOR THE DESIGN OF BUILDINGS AND OTHER STRUCTURES

Structures of all material types can be subject to general and progressive collapse during tsunami, but it is feasible to design buildings to withstand extremely large tsunami events

Mid-to-high-rise reinforced concrete buildings with robust shear walls appear to survive structurally and can be successful evacuation structures if tall enough. Steel buildings robustly proportioned at their lower stories could also have similar capability.

Overtuning with buoyancy should be considered as a tsunami design condition for foundation anchorage and the superstructure.

Foundation system should consider uplift and scour effects particularly at corners. Scour depth is not linearly proportionate to the depth of inundation. Flow diversion and acceleration around large buildings significantly focus flow on downstream buildings.

Debris accumulation in tsunami inflow occurs rapidly once structures are encountered. Loads on structures must consider debris damming and blockage.

Have sufficient openness in buildings to alleviate buoyancy.

Avoid potential structurally boxed-in areas that will be subject to hydrodynamic pressurization.

Building lateral strength and local element resistance to impact are key to building survivability. Seismic design may not assure sufficient tsunami resistance, particularly for low-rise buildings.

5. REFERENCES

1. Chock, G., Robertson, I., Kriebel, D., and Francis, M., Tohoku Japan Tsunami of March 11, 2011 – Performance of Structures, ASCE/SEI, (in publication), 2011.
2. Robertson I.N., Paczkowski, K., Riggs, H.R., Mohamed, A., , “Tsunami Bore Forces on Walls”, *Proceedings of the ASME 2011 30th International Conference on Ocean, Offshore and Arctic Engineering*, June 19-24, 2011, Rotterdam, The Netherlands.
3. Yu, G., and Chock, G., Comparison of USA and Japan Seismic Design Procedures, (manuscript in preparation).
4. Kuromoto, H., Seismic Design Codes for Buildings in Japan, *Journal of Disaster Research*, Vol.1 No. 3, 341- 356, 2006.
5. Chock, G., Overview of Current USA Seismic Design Provisions for New Construction, China/USA Symposium for the Advancement of Earthquake Sciences and Hazard Mitigation Practices, Beijing, China, October, 2010.

The impulsive tsunami source of the 2011 Off the Pacific Coast of Tohoku Earthquake estimated from seismic wave and offshore tsunami data

by

Yutaka Hayashi¹, Hiroaki Tsushima², Yasuhiro Yoshida³, Takashi Yokota⁴

ABSTRACT

Offshore tsunami waveform data suggested that the maximum-amplitude tsunami at Tohoku district brought by the 2011 Off the Pacific Coast of Tohoku Earthquake was relatively short-period. By comparison of seismic and tsunami source models, we conclude that the source of tsunami with this short-period and large amplitude, namely impulsive tsunami, probably was generated in the area from the epicenter to the Japan Trench offshore.

KEYWORDS: Impulsive Tsunami Source, 2011 Off the Pacific Coast of Tohoku Earthquake, Strong Motion Waveform Inversion, Tsunami Back-propagation, Tsunami Waveform Inversion

1. INTRODUCTION

A massive M_w 9.0 earthquake occurred at 14:46 JST (05:46 UTC) on March 11, 2011, off the Pacific coast of the northeastern part of Honshu, Japan; it is named the 2011 off the Pacific coast of Tohoku Earthquake (abbreviated as 2011 Tohoku earthquake hereinafter in this paper) by Japan Meteorological Agency (JMA) [1]. Its epicenter was southeast of Sendai City ($38^{\circ}06.2'N$, $142^{\circ}51.6'E$) [2]. Seismic intensity of 7, the upper limit of JMA scale, was observed, for only the second time since JMA introduced instrument-based intensity observations in 1996 [3,4]. Intensities of 6-upper and 6-lower were widely observed at many stations in the Tohoku and Kanto districts, over an area of approximately $400\text{km} \times 100\text{km}$ [4]. The tsunami that accompanied the earthquake detected at various offshore observation stations

including coastal wave gauges [5, 6], real-time kinematic global positioning system (RTK-GPS) buoys [7] (Kato et al., 2005), cabled deep ocean-bottom pressure gauges (OBPG) (e.g. [8, 9]), and Deep-ocean Assessment and Reporting of Tsunami (DART) buoys [10]. Especially, OBPGs installed off Tohoku recorded impulsive tsunami with a short-period and large amplitude [11]. Periods of the tsunami initial waves observed at offshore stations at off Hokkaido were longer than those observed at off Iwate and Miyagi. Thus, impulsive tsunami was remarkable at west side of the tsunami source area.

In this paper, following three models are compared: the source of a seismic fault model on slip distribution estimated by strong waveform inversion [12], a tsunami source area estimated from tsunami arrival time data to offshore observatories [13], and a tsunami source area deformation field analyzed by tsunami waveform inversion [14]. Then, the source location of the impulsive tsunami is discussed.

2. STRONG MOTION WAVEFORM INVERSION

The source process of the 2011 Tohoku earthquake has been estimated from regional strong motion data. The strong motion data observed at near distance from the epicenter ($< 500\text{ km}$) is useful to obtain the more detailed view of the source process of large earthquake compared to the teleseismic body waves. Several studies have been performed using strong motion data [e.g. 12, 15]. In this section, we have summarized the results of source process of the 2011 Tohoku earthquake obtained from strong motion waveform inversion by Yoshida *et al.* (2011) [12].

Twenty-three strong motion seismograms from K-NET [16] and KiK-net stations [17], deployed by the National Research Institute for Earth Science and Disaster Prevention (NIED), and from the JMA, were used. Acceleration

¹ Senior Researcher, the 1st Laboratory, Seismology and Volcanology Research Division, Meteorological Research Institute, Tsukuba-shi, Ibaraki-ken 305-00526 Japan

² Researcher, the 1st Laboratory, ditto

³ Senior Researcher, the 2nd Laboratory, ditto

⁴ Director, ditto

seismograms were integrated to velocity, then the data were band-pass filtered between 0.01 and 0.15 Hz and decimated to 0.5 Hz. We used 250 s of data, starting from 10 s before the P wave arrivals. The strike and dip angles of the fault plane was fixed at 201° and 9°, respectively. The fault size was taken to be 475 km × 175 km, and the rupture was assumed to start at the hypocenter of the mainshock determined by JMA. We divided the fault into subfaults 25 km × 25 km in size.

The Green's function for each subfault was calculated by the discrete wavenumber method [18] using the reflection-transmission matrices [19]. The anelasticity effect was included by the use of complex velocity [20]. The moment rate function for each subfault was expressed by 20 basic triangle functions with 8 s duration overlapping by 4 s. The maximum rupture velocity was set at 2.5 km/s to minimize variance. We used the linear multiple time window inversion method with constraints on the smoothness of the spatiotemporal slip distribution [e.g. 21, 22]. The smoothness parameters (hyperparameters) were selected to minimize Akaike's Bayesian information criterion (ABIC) [23, 24]. Waveforms were aligned by onset time and weights on waveforms were equal for all stations.

Figure 2 shows the slip distribution obtained from the regional strong motion data analysis. The total seismic moment was 3.4×10^{22} Nm ($M_w = 9.0$). The slip area extends eastward from the hypocenter to the shallower part of the fault plane. The maximum slip amount is 38 m. The overall fit between observed and synthetic waveforms is quite good with a reduction in variance of about 91%.

The history of released seismic moment is as follows. In the first stage of the rupture (0–40 s), the rupture expands outward from the hypocenter. In the next stage (40–80 s), the rupture area extends toward the shallow part of the fault plane in both north and south directions. This stage causes large slip amounts and may be related to the generation of the large tsunami. The rupture velocity is very slow (about 1 km/s) during the first and second stages. In the third stage (after 80 s), the rupture extends southward, reaching the southern end of the fault plane at 160 s.

3. BACK-PROPAGATION OF TSUNAMI ARRIVAL TIME

In this section, we have summarized the results of tsunami source area obtained by back-propagation of tsunami arrival time by Hayashi et al. (2011) [13].

The 2011 Tohoku earthquake tsunami was detected in a time-series observation data of sea-level heights or ocean-bottom pressures. Waveform data were acquired from total of 21 stations; MLIT (each coastal wave gauge and RTK-GPS buoy), JAMSTEC (stations KPG-1 and 2), ERI at the University of Tokyo (stations TM-1 and 2), JMA (stations Boso-2 and 3), NOAA (DART 21413 and 21418), and RFERHR (DART 21401). From the filtered waveforms, tsunami arrival times of each phase are manually read.

To find the edge of the tsunami source area, Huygen's principle was applied to back-propagate the tsunami from each observation station. For these calculations we used Geoware tsunami travel-time software (TTT v. 3.0) and bathymetric data at one-minute intervals (ETOPO1 [25]). The phase velocity of tsunami propagation was assumed to be equal to the square root of gravity multiplied by bathymetry. For very large earthquakes, the difference between the time of the main shock and the generation of the tsunami is not negligible [26]. Therefore, for back-propagation using tsunami arrival times, modification values are used by 1 min corresponding to a distance of 120 km from the epicenter to the contact point of the back-propagation line and the tsunami source area (Fig. 3a). This correction is to account for typical differences between the time of the main shock and the generation of the tsunami; this is almost equivalent to assuming an averaged apparent (i.e. projected to the seafloor) fault rupture velocity of 2 km/s.

The tsunami source area of the 2011 Tohoku earthquake, determined by back-propagation of tsunami arrivals from offshore observation stations, is indicated in Fig. 3a. The tsunami source area was approximately 500-km long with a maximum width of about 200 km. The eastern edge of the tsunami source area was along the west side of the Japan Trench, and the southern one was near N36°. Meanwhile, the aftershock

area [1] includes the east side of the trench and the south of $N36^\circ$. Sea-level observed at TM1, TM2, GPS804, GPS802, GPS803, and GPS801 started to change almost instantly with the arrival of a seismic wave at each station. Therefore, these offshore stations were within the tsunami source area.

Back-propagation methods were also applied to the primary crests to discuss the location of major seafloor uplift in the tsunami source area. However, this was done only for the primary crests observed by OBPGs and GPS buoys, in order to limit data to near-field tsunami in deep sea, so that using data strongly affected by non-linear effects or dispersions was avoided as much as possible.

Back-propagation curves of the primary crests observed during the 2011 Tohoku earthquake tsunami are indicated in Fig. 3. All curves, except those from GPS807 and GPS806, go through the area near $N38^\circ E143.5^\circ$ surrounded by the gray dotted line in Fig. 3b. The area is several tens of kilometers east away from the epicenter. If the seafloor uplift area identified was confined only within the small area through which most back-propagation curves of the primary crests go (Fig. 3b), most of the arrival-time data of the primary crests observed at GPS buoys or OBPGs can be reasonably explained.

However, this is but one of the possible solutions which can explain the timing of the primary crests, from following reasons.

One reason is, of course, that uplifted area from a great earthquake such as the 2011 Tohoku Earthquake may be excited at multiple locations (e.g. more than one seafloor uplifted area) in the source area. In this case, it may be difficult to find the location of the maximum uplift area from the back-propagation curves of the primary crests from each station.

The other reason is that the back-propagation analysis is based on the assumption that the tsunami phase-velocity is equal to the square root of gravity multiplied by bathymetry. Nonlinearity of the phase velocity results in wave crests moving faster than this assumption; on the other hand, dispersion results in crests moving slower. These effects may cause some estimation errors in the highly-uplifted area.

The latter reason might be why it is difficult to

explain the back-propagation curves from GPS807 and GPS806 (Fig. 3), unless the seafloor-uplift area has some extension in the north-to-south direction, instead of assuming the only seafloor uplift exists east of the epicenter.

4. TSUNAMI WAVEFORM INVERSION

Tsunami waveform inversion is a technique to determine a tsunami source, which is a spatial distribution of earthquake fault slip or that of an initial sea-surface displacement, from observed tsunami waveforms by a least-square approach. Many studies have applied this technique to the records of the past tsunami events [27, 28, 29, 30], as well as the 2011 Tohoku earthquake [31], and found the source characteristics of those earthquakes. Furthermore, a couple of studies have proposed a tsunami forecasting algorithm based on inversion of offshore tsunami waveforms [14, 32, 33, 34]. In this section, we have summarized the results of tsunami source region of the 2011 Tohoku earthquake by tsunami waveform inversion by Tsushima et al. (2011) [14].

The huge tsunami generated by the 2011 Tohoku earthquake was recorded at several offshore tsunami stations as shown in Fig. 1. Tsunami waveforms observed at offshore provide a tsunami source signature without distortions due to complex coastal topography [35]. Taking the advantage, in our tsunami inversion we used the offshore tsunami waveform data acquired at the four ocean bottom pressure gauges (OBPGs) and five GPS buoys deployed at offshore around Japan, meaning near-field tsunami data (Figs. 4a and 4b). The impulsive tsunami was recorded at OBPG stations TM1 and TM2, and GPS buoys 802 and 804. It is noteworthy that the only parts of waveform data which had been available on real-time basis were used in our tsunami inversion.

We estimated the distribution of an initial sea-surface displacement as tsunami source model. The inversion method applied here is a part of a tsunami forecasting algorithm developed by his previous study [34]. In the inversion, two constraints are imposed to stabilize the solution of an inverse problem. One is smoothing and the other is damping constraint. The damping constraint is based on *a priori* information that an

initial sea-surface displacement due to a tsunamigenic earthquake should be zero if the epicenter is far enough away. The tsunami Green's functions were computed by the finite-difference approximation of the linear long-wave equations [36].

The comparison between the observed tsunami waveforms and the calculations shows good agreement (Figs. 4a and 4b). The uplifted area estimated by the tsunami inversion is distributed circularly from the epicenter to the trench (Fig. 4c). It is difficult to determine the more accurate location and extent of the source area of the impulsive tsunami because the azimuthal coverage of the offshore stations is not sufficient [14], but the result indicates the possibility that the significantly elevated sea-surface source is located within and/or around the estimated elevation area near the trench.

5. DISCUSSION AND CONCLUSIONS

The impulsive tsunami waves are corresponding to the primary crests detected at offshore observatories located off the Pacific coast of Tohoku district (Fig. 1). Tsunami waveform inversion determined highly-uplifted area from the epicenter to the trench (Section 4 and Fig. 4c). And, as described in Section 3, if highly-uplifted area exists between epicenter and the trench (Fig. 3b), timings of the primary crests observed at most offshore stations. In addition, the area of large slip obtained from the inversion of seismic strong-motion waves [12] is almost coincident with the area marked in Fig.3b and highly-uplifted area in Fig.4b.

Therefore, we conclude that the origin of the impulsive tsunami, which brought initial high tsunami to the Pacific coast of Tohoku, probably was from the epicenter to the Japan Trench.

6. REFERENCES

- [1] Hirose, F., K. Miyaoka, N. Hashimoto, T. Yamazaki, and M. Nakamura, Outline of the 2011 off the Pacific coast of Tohoku Earthquake (*Mw* 9.0)—Seismicity: foreshocks, mainshock, aftershocks, and induced activity—, *Earth Planets Space*, **63**, 2011 (in print).
- [2] Japan Meteorological Agency, *Monthly Report on Earthquakes and Volcanoes in Japan March 2011*, pp.57-148, 2011 (in Japanese).
- [3] Hoshihara, M., K. Ohtake, K. Iwakiri, T. Aketagawa, H. Nakamura, and S. Yamamoto, How precisely can we anticipate seismic intensities? A study of uncertainty of anticipated seismic intensities for the Earthquake Early Warning method in Japan, *Earth Planets Space*, **62**, 611-620, 2010.
- [4] Hoshihara, M., K. Ohtake, K. Iwakiri, T. Aketagawa, H. Nakamura, and S. Yamamoto, Outline of the 2011 off the Pacific coast of Tohoku earthquake (*Mw*9.0) - earthquake early warning and observed seismic intensity -, *Earth Planets Space*, 2011 (in print).
- [5] Nagai, T., Development and improvement of the Japanese coastal wave observation network (NOWPHAS), *J. Jpn. Soc. Civil. Eng.*, no. 609 (VI- 41), 1-14, 1998 (in Japanese).
- [6] Nagai, T., S. Satomi, Y. Terada, T. Kato, K. Nukada, and M. Kudaka, GPS buoy and 4 seabed installed wave gauge application to offshore tsunami observation, *Proceedings of the 15th International Offshore and Polar Engineering Conference*, Volume III, 292-299, 2005.
- [7] Kato, T., Y. Terada, K. Ito, R. Hattori, T. Abe, T. Miyake, S. Koshimura, and T. Nagai, Tsunami due to the 2004 September 5th off the Kii Peninsula earthquake, Japan, recorded by a new GPS buoy, *Earth Planets Space*, **57**, 279-301, 2005.
- [8] Fujisawa, I., S. Tateyama, and J. Fujisaki, Permanent ocean-bottom earthquake and tsunami observation system off the Boso Peninsula, *Weath. Serv. Bull.*, **53**, 127-166, 1986 (in Japanese).
- [9] Hirata, K., M. Aoyagi, H. Mikada, K. Kawaguchi, Y. Kaiho, R. Iwase, S. Morita, I. Fujisawa, H. Sugioka, K. Mitsuzawa, K. Suyehiro, H. Kinoshita, and N. Fujiwara, Real-time geophysical measurements on the deep seafloor using submarine cable in the southern Kurile subduction zone, *IEEE J. Ocean Eng.*, **27**, 170-181, 2002.
- [10] González, F. I., E. N. Bernard, C. Meinig, M. C. Ebel, H. O. Mofjeld, and S. Stalin, The NTHMP tsunameter network, *Nat. Hazards*, **35**, 25-39, doi:10.1007/s11069-004-2402-4,

- 2005.
- [11] Ito, Y., T. Tsuji, Y. Osada, M. Kido, D. Inazu, Y. Hayashi, H. Tsushima, R. Hino, and H. Fujimoto, Frontal wedge deformation near the source region of the 2011 Tohoku-Oki earthquake, *Geophys. Res. Lett.*, 2011 (in print).
- [12] Yoshida, Y., H. Ueno, D. Muto, and S. Aoki, Source process of the 2011 Off the Pacific Coast of Tohoku Earthquake with the combination of teleseismic and strong motion data, *Earth Planets Space*, **63**, 2011 (in print).
- [13] Hayashi, Y., H. Tsushima, K. Hirata, K. Kimura, and K. Maeda, Tsunami source area of the 2011 off the Pacific Coast of Tohoku Earthquake determined from tsunami arrival times at offshore observation station, *Earth Planets Space*, **63**, 2011 (in print).
- [14] Tsushima, H., K. Hirata, Y. Hayashi, Y. Tanioka, K. Kimura, S. Sakai, M. Shinohara, T. Kanazawa, R. Hino, and K. Maeda, Near-field tsunami forecasting using offshore tsunami data from the 2011 off the Pacific coast of Tohoku Earthquake, *Earth Planets Space*, **63**, 2011 (in print).
- [15] Suzuki, W., S. Aoi, and H. Sekiguchi, Source inversion analysis of the 2011/3/11 Off the Pacific Coast of Tohoku Earthquake using regional strong motion data, http://www.kyoshin.bosai.go.jp/kyoshin/topics/TohokuTaiheiyo_20110311/inversion/, 2011 (in Japanese).
- [16] Kinoshita, S., Kyoshin net (K-NET), *Seism. Res. Lett.*, **69**, 209-332, 1998.
- [17] Aoi, S., K. Obara, S. Hori, K. Kasahara, and Y. Okada, New Strong-Motion Observation Network: Kik-net, *EOS Trans. AGU*, p. 329, 2000.
- [18] Bouchon, M., A simple method to calculate Green's functions for elastic layered media, *Bull. Seism. Soc. Am.*, **71**, 959-971, 1981.
- [19] Kennett, L. N. and N. J. Kerry, Seismic waves in a stratified half space, *Geophys. J. R. Astr. Soc.*, **57**, 557-583, 1979.
- [20] Takeo, M., Near-field synthetic seismograms taking into account the effect of anelasticity, *Meteorol. Geophys.*, **36**, 245-257, 1985 (in Japanese).
- [21] Ide, S., M. Takeo, and Y. Yoshida, Source process of the 1995 Kobe earthquake: Determination of spatio-temporal slip distribution by Bayesian modeling, *Bull. Seismol. Soc. Am.*, **86**, 547-566, 1996.
- [22] Nakayama, W. and M. Takeo, Slip history of the 1994 Sanriku-haruka-oki, Japan, earthquake deduced from strong-motion data, *Bull. Seismol. Soc. Am.*, **87**, 918-931, 1997.
- [23] Akaike, H., Likelihood and the Bayes procedure, in Bayesian statistics, Edited by J. M. Bernardo, M. H. DeGroot, D. V. Lindley, and A. F. M. Smith, University Press, Valencia, Spain, 1980.
- [24] Fukahata, Y., Y. Yagi, and M. Matsu'ura, Waveform inversion for seismic source processes using ABIC with two sorts of prior constraints: comparison between proper and improper formulations, *Geophys. Res. Lett.*, **30**(6), 1305, doi:10.1029/2002GL016293, 2003.
- [25] Amante, C. and B. W. Eakins, ETOPO1 1 arc-minute global relief model: Procedures, data source and analysis, *NOAA Technical Memorandum*, NESDIS NGDC-24, 19p, 2009.
- [26] Seno, T. and K. Hirata, Did the 2004 Sumatra-Andaman earthquake involve a component of tsunami earthquakes?, *Bull. Seismol. Soc. Am.*, **97**, S296-S306, 2007.
- [27] Satake, K., Inversion of tsunami waveforms for the estimation of heterogeneous fault motion of large submarine earthquakes: The 1968 Tokachi-oki and 1983 Japan Sea earthquakes, *J. Geophys. Res.*, **94**, 5627-5636, doi:10.1029/JB094iB05p05627, 1989.
- [28] Tanioka, Y., Yudhicara, T. Kususose, S. Kathiroll, Y. Nishimura, S. Iwasaki, and K. Satake, Rupture process of the 2004 great Sumatra-Andaman earthquake estimated from tsunami waveforms, *Earth Planets Space*, **58**, 203-209, 2006.
- [29] Fujii, Y., and K. Satake, Tsunami sources of the November 2006 and January 2007 great Kuril earthquakes, *Bull. Seism. Soc. Am.*, **98**, 1559-1571, doi:10.1785/0120070221, 2008.
- [30] Saito, T., K. Satake, and T. Furumura, Tsunami waveform inversion including dispersive waves: the 2004 earthquake off Kii Peninsula, Japan, *J. Geophys. Res.*, **115**, B06303, doi:10.1029/2009JB006884, 2010.
- [31] Fujii, Y., K. Satake, S. Sakai, M. Shinohara, and T. Kanazawa, Tsunami source of the

- 2011 off the Pacific coast of Tohoku, Japan Earthquake, *Earth Planets Space*, **63**, 2011 (in press).
- [32] Titov, V. V., F. I. González, E. N. Bernard, M. C. Eble, H. O. Mojfeld, J. C. Newman, and A. J. Venturato, Real-time tsunami forecasting: Challenges and solutions, *Nat. Hazards*, **35**, 35-41, doi:10.1007/s11069-004-2403-3, 2005.
- [33] Wei, Y., E. N. Bernard, L. Tang, R. Weiss, V. V. Titov, C. Moore, M. Spillane, M. Hopkins, and U. Kanoglu, Real-time experimental forecast of the Peruvian tsunami of August 2007 for U.S. coastlines, *Geophys. Res. Lett.*, **35**, L04609, doi:10.1029/2007GL032250, 2008.
- [34] Tsushima, H., R. Hino, H. Fujimoto, Y. Tanioka, and F. Imamura, Near-field tsunami forecasting from cabled ocean bottom pressure data, *J. Geophys. Res.*, **114**, B06309, doi:10.1029/2008JB005988, 2009.
- [35] González, F. I., E. N. Bernard, C. Meinig, M. Eble, H. O. Mofjeld, and S. Stalin, The NTHMP tsunameter network, *Nat. Hazards*, **35**, 25-39, doi:10.1007/s11069-004-2402-4, 2005.
- [36] Satake K., Linear and nonlinear computations of the 1992 Nicaragua earthquake tsunami, *Pure Appl. Geophys.*, **144**, 455-470, doi:10.1007/BF00874378, 1995.

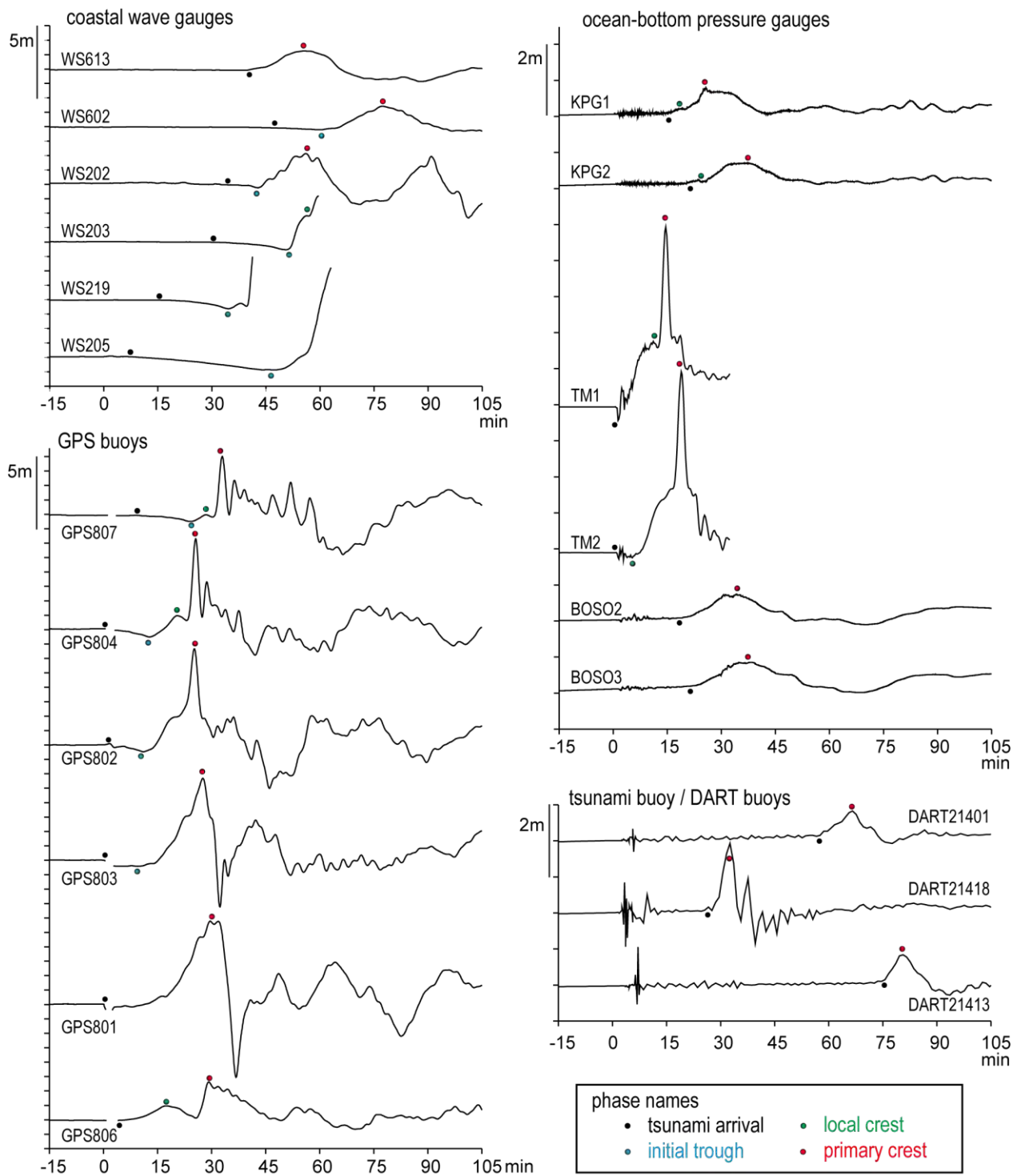

Fig. 1. Tsunami waveforms recorded offshore for the 2011 Tohoku earthquake and phase nomenclature [14]. Data are low-pass filtered. See Fig. 3 for locations of observation stations.

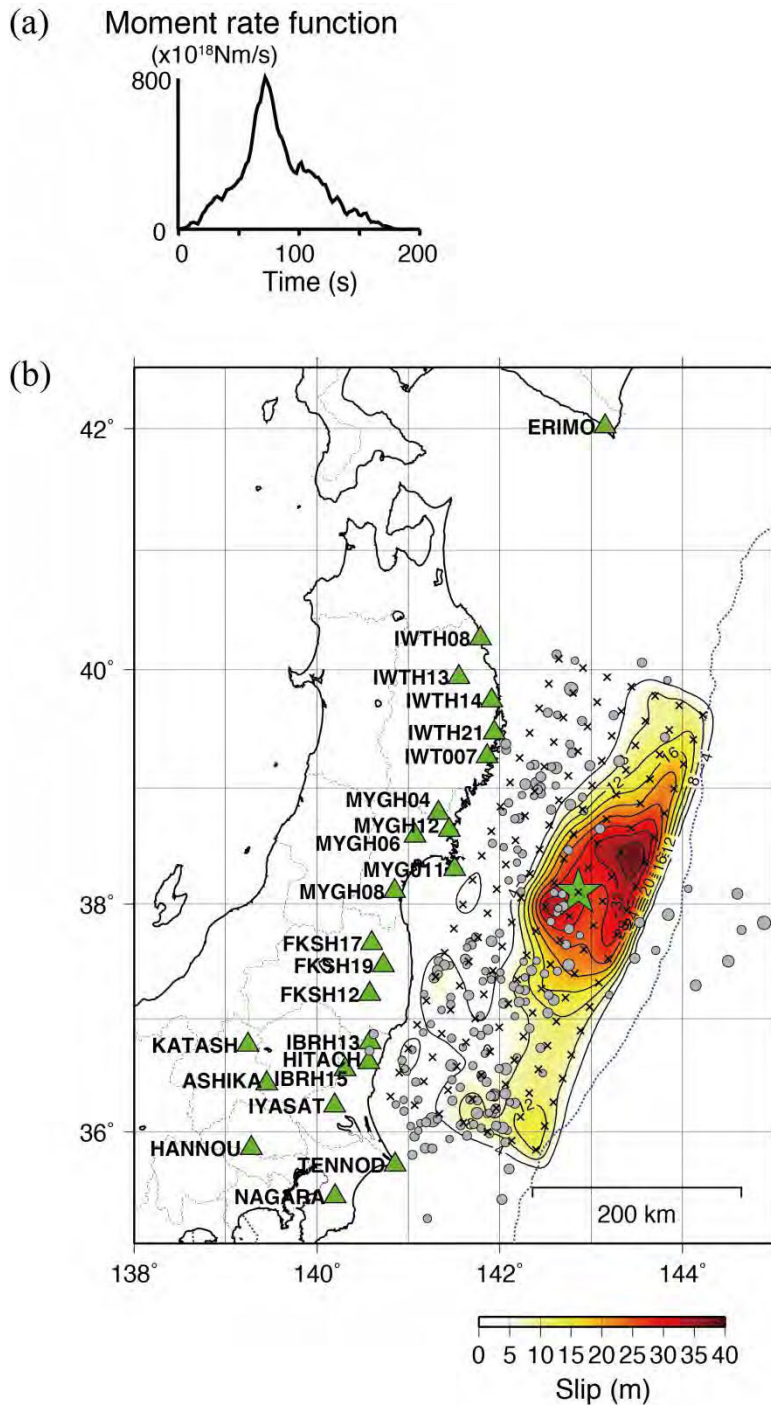

Fig. 2 Finite-source model from inversion of strong motion waves [12]. (a) Moment rate function. (b) Slip distribution on the fault. Large green star represents the epicenter of the mainshock ($M_w = 9.0$), and gray circles represent aftershocks ($M \geq 5.0$) within 24 h of the mainshock. Crosses represent grid points on the fault plane for calculating synthetic waveforms. Triangles denote seismic stations used in this analysis. Contour interval in slip distribution is 4 m.

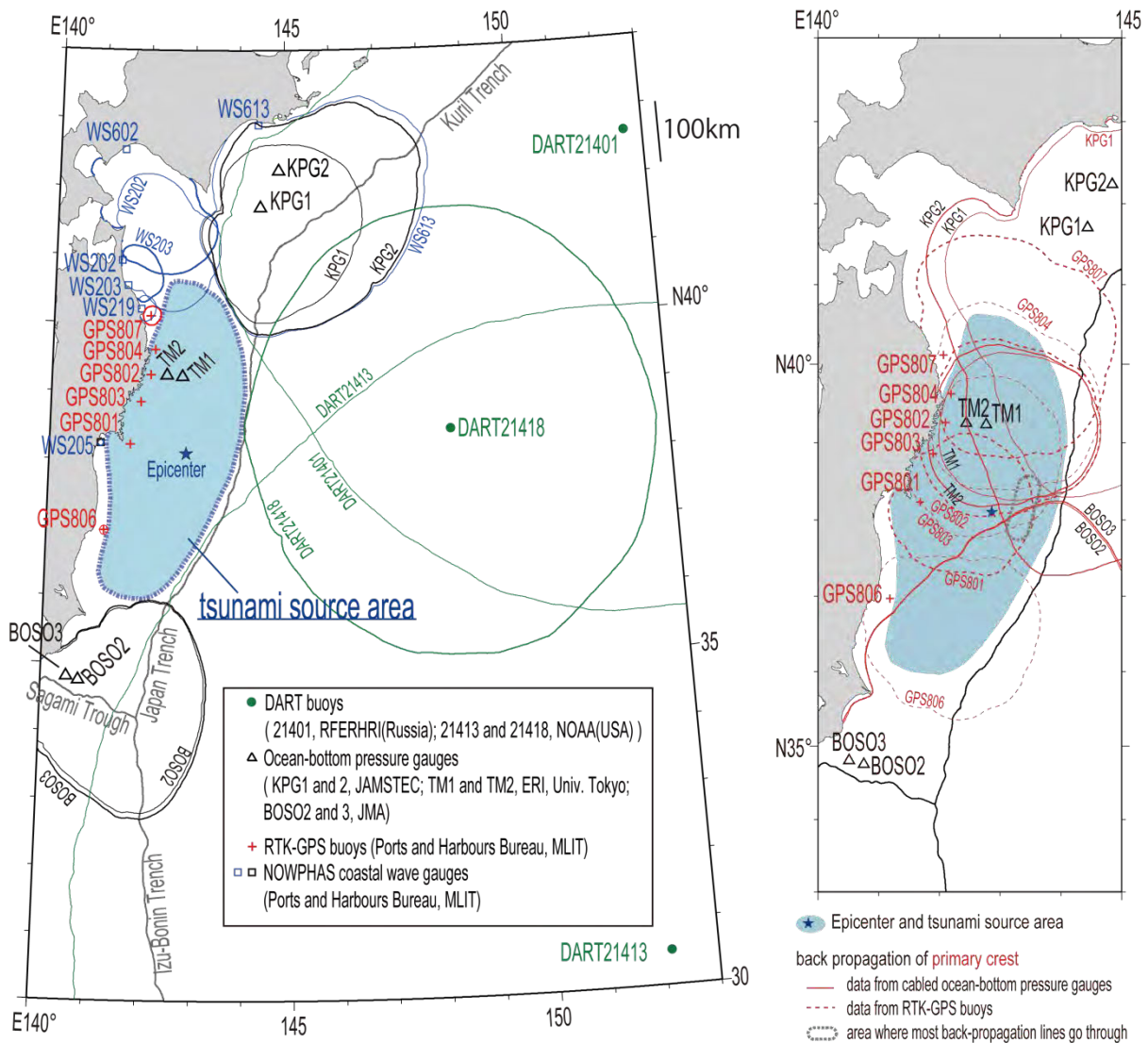

Fig. 3. Tsunami source area of the 2011 Tohoku earthquake determined by the back-propagation of tsunami arrivals (left) and occurrence times of the primary crests (right) from offshore observation stations [13].

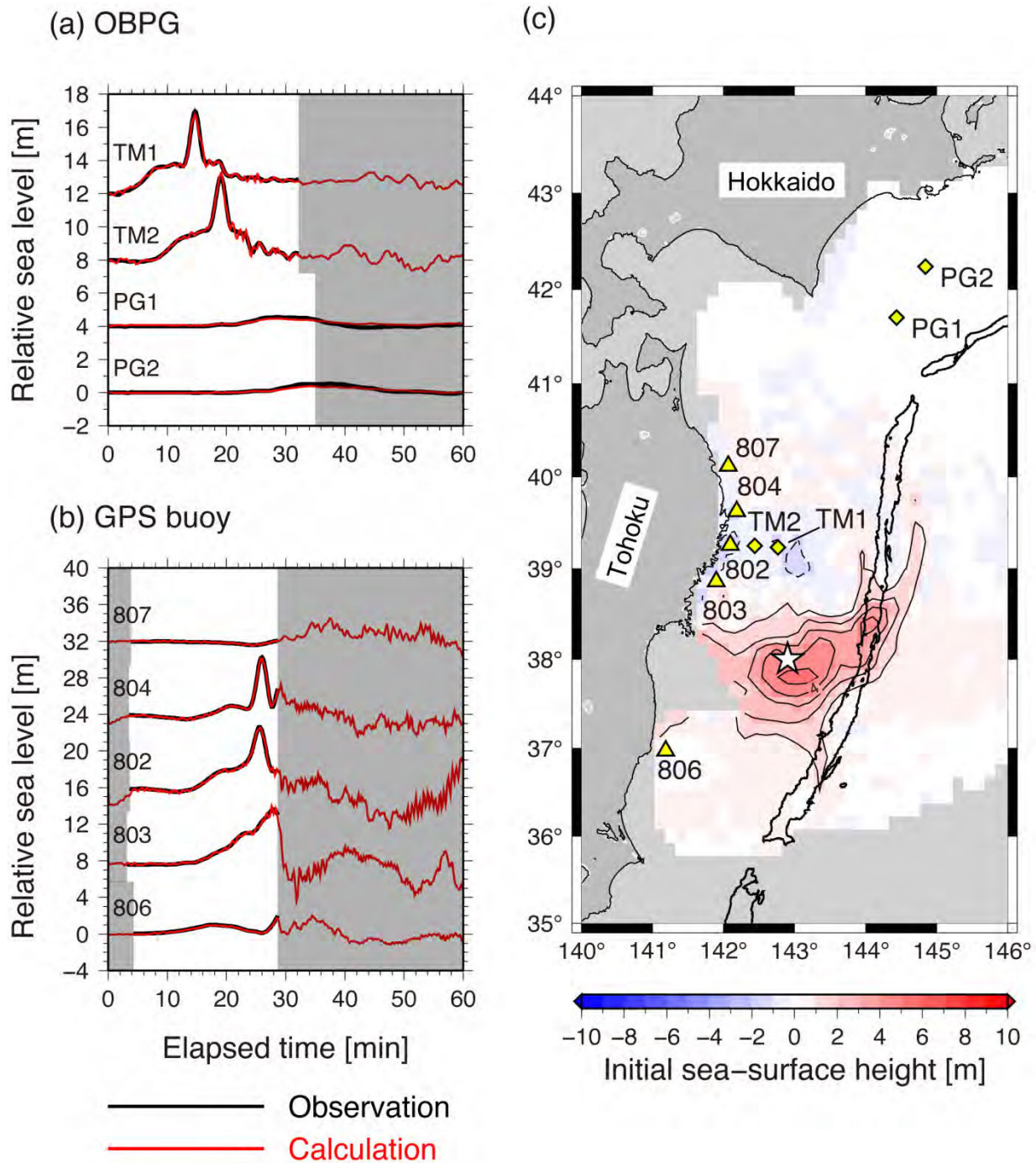

Fig. 4. Result of tsunami waveform inversion using the offshore tsunami waveforms from the 2011 Tohoku earthquake. Comparison of observed (black lines) and calculated (red lines) waveforms at (a) four OBPGs and (b) five GPS buoys. The waveforms in unshaded areas of each panel were used in the inversion. (c) Distribution of the initial sea-surface height estimated by tsunami waveform inversion. Star indicates earthquake epicenter used as the damping constraint in the inversion. Areas shaded gray are outside the influence area. Contour interval is 1 m.

APPENDIX

TASK COMMITTEE REPORTS

Report of Task Committee B BUILDINGS

Date: 29 August 2011

Place: National Institute for Land and Infrastructure Management, Tsukuba, Japan

Attendees:	U.S. Side --	Steven McCabe (Acting Chair)	NIST
		Mehmet Celebi	USGS
		Jeffrey Dragovich	NIST
		James R. Harris	J. R. Harris & Company
		Stephen Mahin	UCB
		Joy Pauschke	NSF
		Julio Ramirez	Purdue University
	Japan Side --	Isao Nishiyama (Co-Chair)	NILIM
		Hiroshi Fukuyama (Co-Chair)	BRI
		Yoshihiro Iwata	NILIM
		Seitaro Tajiri	BRI

1. Objective and Scope of Work

(1) Objective:

The objective of the Task Committee is to improve the seismic performance of buildings in the U.S. and Japan, thus reducing future earthquake damage to buildings. This Task Committee accomplishes this objective by promoting sharing technical information, performing appropriate cooperative research, exchanging personnel to address common issues, and working together to translate research results into the seismic provisions of codes and standards in the U.S. and Japan.

(2) Scope of Work:

- a) Conduct joint workshops and meetings to identify new technical information and possible research cooperation/collaboration for the development of improved codes and standards.
- b) Encourage the development, enhancement and application of new technologies and design methods to improve safety, sustainability and productivity of buildings and to improve the resilience of buildings and infrastructure.
- c) Coordinate development of databases, test procedures, and guidelines for interpretation of test results and their applications.
- d) Coordinate joint research including the utilization of experimental facilities.
- e) Enhance the exchange of information and personnel.

2. Accomplishments

The earthquake motion induced building damage due to the 2011 Great East Japan Earthquake and resulting administrative issues as the lessons from the earthquake were presented and shared. Joint field reconnaissance was conducted to investigate damage to retrofitted buildings, seismically isolated buildings, and buildings designed based on the current code or the previous code in Japan. An excellent workshop on motion induced building damage was also conducted in Tohoku University with Prof. M. Maeda. The strong motion data recorded in the annex building of NILIM and BRI and its drawings will be shared for future cooperative research.

3. Future Plans

A number of future cooperative activities were discussed in an excellent Task Committee meeting. It was

decided to engage in the following:

- (1) A common concern about wall performance was identified. A program to develop cooperative planning of research to coordinate testing and analytical studies is to be developed.
- (2) The Task Committee endorsed a proposed workshop to be held probably in 2012 with engineers from Japan, US, Chile and New Zealand to discuss building performance in the recent earthquakes. ASCE has proposed this workshop with requests that NEHRP and UJNR be sponsors.
- (3) Future workshops, "U.S.-Japan Workshop on Earthquake Engineering in Building Codes and Standards", will be held periodically to share technical information which can be reflected within the technical codes and standards of the respective countries.

Report of Task Committee C DAMS

Date: 29 August 2011

Place: National Institute for Land and Infrastructure Management, Tsukuba, Japan

Attendees: U.S. Side -- Robert Hall (Acting Chair) USACE
Japan Side -- Yoshikazu Yamaguchi (Chair) PWRI
Masafumi Kondo PWRI

1. Objective and Scope of Work

To promote better understanding of the response of dams to dynamic loads, the T/C will identify, coordinate, and support initiatives by government agencies, private sector, and professional organizations to advance the safety and resilience of these critical structures, improve their performance under dynamic loading, and promote effective remediation measures.

The scope of work includes:

- (1) Identify, review, and assess methods for dynamic analysis and performance evaluation of dams.
 - a) Assessment of models and numerical procedures used for non-linear response analysis of concrete and embankment dams.
 - b) Definition of input ground motions for non-linear analysis.
 - c) Assessment of performance-based design and analysis approaches.
 - d) Development of effective counter-measure alternatives.
- (2) Identify, review, and assess physical modeling efforts supporting dynamic analysis and performance evaluation of dams.
 - a) Determination of strength and deformation characteristics of concrete, soil, and rock materials under dynamic conditions.
 - b) Experimental evaluation of non-linear performance (e.g., shake table testing, centrifuge testing, etc.).
- (3) Evaluate observed performance during earthquakes.
 - a) Support and calibrate empirical techniques for simplified assessment.
 - b) Review observed failure and damage mechanisms to improve the development of advanced numerical models.
 - c) Application of the analysis of the observed dynamic behavior to the improvement of design and evaluation criteria.
- (4) Collaborate with academia and professional organizations to promote information sharing across the dam engineering community.

2. Accomplishments

- (1) Technical exchange and collaborative research on *Nonlinear response analysis and discrete element method analyses of concrete dams* has been conducted between the U.S. (U.S. Army Engineer Research and Development Center) and Japan (Public Works Research Institute). The shaking table experiments for crack-segmented concrete specimens considering the uplift pressure in a crack were successfully conducted at PWRI in 2009 and 2010. The U.S. Bureau of Reclamation is continuing to conduct shaking table tests at different scales and nonlinear response analyses, and the joint comparison and evaluation of test and analysis results will be extremely beneficial to advance the state of the art in constitutive modeling of mass concrete structures.
- (2) Technical exchange and collaborative research on *Experimental characterization of nonlinear tensile behavior of mass concrete* has been conducted between U.S. (U.S. Army Engineer Research and

- Development Center & U.S. Bureau of Reclamation) and Japan (Public Works Research Institute).
- (3) The Task Committee extended an invitation to professional organizations, such as the U.S. Society on Dams and Japan Commission on Large Dams, to actively participate as members of the Task Committee by designating the corresponding representatives. Some engineers and professors have become new members of the Task Committee from these professional organizations.

3. Future Plans

- (1) The Task Committee will continue the current efforts focused on the development of improved mechanisms to facilitate the continuous exchange of results of research activities and general technical information related to the performance of dams under dynamic loading.
- (2) The Proceedings of the *4th U.S.-Japan Workshop on Advanced Research on Dams* will be published in 2011.
- (3) The Task Committee will conduct a U.S.-Japan joint reconnaissance on four dams damaged due to the 2011 Great East Japan Earthquake from August 31 through September 2, 2011.
- (4) The Task Committee will pursue collaborative efforts with the professional organizations, such as the U.S. Society on Dams and Japan Commission on Large Dams, and will seek to hold joint workshops, seminars, and other means of technical exchange in conjunction with their regularly scheduled conferences and annual meetings.
- (5) The Task Committee will hold the *5th U.S.-Japan Workshop on Advanced Research on Dams* in 2012. Specific location and time of the Workshop will finally be determined through correspondence between the Chairs of the Task Committee on Dams.
- (6) The Task Committee will coordinate exchange visits of scientists and engineers from the U.S. and Japan. A series of case histories of mutual interest will be identified and prioritized and they will serve as the focus for this exchange program.
- (7) The Task Committee will identify and promote collaborative opportunities on the following research areas:
 - a) ***Criteria for seismic analysis progression:***
The Task Committee will support the review and comparison of the state of practice in the U.S. and Japan regarding current recommendations for progression of seismic analysis based on stages of increasing complexity.
 - b) ***Seismic evaluation of embankment dams:***
The Task Committee will support the review of criteria and guidelines for post-earthquake stability and deformation analysis of embankment dams.
 - c) ***Dam-foundation interaction:***
The Task Committee will support the development of improved numerical models for dam-foundation interaction.

4. Related Activities

- (1) PWRI researchers conducted detailed field investigations on dams damaged due to the 2011 Great East Japan Earthquake, and made safety evaluation of these dams. They also summarized the results of the field investigations, and submitted the technical paper titled *Safety Inspections and Seismic Behavior of Dams during the 2011 Off the Pacific Coast of Tohoku Earthquake* to the 24th Congress of International Commission on Large Dams (ICOLD), which will be held in 2012 at Kyoto, Japan.

Report of Task Committee D WIND ENGINEERING

Date: 29 August 2011

Place: National Institute for Land and Infrastructure Management, Tsukuba, Japan

Attendees:

U.S. Side --	Long Phan (representing Co-Chair Marc Levitan)	NIST
	Solomon Yim	OSU
	Gary Chock	Martin & Chock, Inc.
Japan Side --	Yasuo Okuda (Co-Chair)	BRI
	Takashi Tomita	PARI
	Masaomi Nakamura	MRI
	Toshikazu Kabeyasawa	BRI

1. Objective and Scope of Work

To exchange technical information and to jointly plan, promote, and foster research and dissemination, in order to improve understanding of wind and its effects on structures, to establish more rational wind-resistant design procedures for structures, and to contribute collaboratively and synergistically to wind hazard mitigation. Specific objectives for the Task Committee include:

- (1) Strategically and collaboratively, identify research needs in wind hazard mitigation in the areas of new impacts of wind events.
- (2) Facilitate cooperation and collaborative research between U.S. and Japanese researchers in wind engineering.
- (3) Identify and exchange successes in wind engineering and wind hazard mitigation.

The scope of the US-Japan collaboration includes:

- (1) Characterization of strong wind, especially boundary layer extreme winds.
- (2) The study of wind effects including wind loading on and wind-induced response of structures.
- (3) Performance of experimental and analytical research to predict wind effects.
- (4) Sharing damage surveys of wind hazard and storm surge and risk assessments in cooperation with Task Committee H.
- (5) Development of new technologies for wind hazard mitigation.

2. Accomplishments

- (1) A presentation of collaborative research concerned with a large tornado simulator was made at the ICWE13 in July, 2011.
- (2) US shared information on tornado damage in the US from the May 22, 2011 Joplin Missouri tornado.
- (3) US and Japan communicated on potential sharing of Japanese building aerodynamics data, for possible expansion of the NIST database-assisted-design tools.

3. Future Plans

- (1) The 6th US-Japan Workshop on Wind Engineering will be held in Yokohama in 2014.
- (2) Conduct collaborative research on the following topics. More concrete subjects were proposed at 5th US-Japan workshop in 2010.
 - a) Wind effects on buildings and wind energy systems (land based and offshore)
→ Continuation of ongoing collaborative study of tornadic flow and effects on buildings structures
 - b) Wind effects on bridges

- Follow-up of benchmark study on flutter derivatives
- c) Evolving Technologies
 - Development of collaborative research on emerging innovative techniques for laboratory modeling and instrumentation
- (3) Exchange technical information on the following topics.
 - a) Wind characteristics and wind hazards
 - Conduct study on the urban flow using CFD simulation of flow over the cities
 - b) Wind pressures, loadings and performance of buildings
 - Development of database of pressures on roofs and solar panels, resulting from comparative study carried out in Japan
 - c) Wind-induced response of flexible, cable-suspended bridges and their components
 - d) New prediction and mitigation techniques for wind effects
 - Use C_p pressure coefficient of hip roof and parapet
 - e) Share the database of storm damage assessments with Task Committee H.
 - Establish wind induced damage database for buildings and infrastructure in Japan and US
- (4) Engage in more regular interaction and communication among Task Committee members. Use email and exchange visits between full Panel meetings were suggested as a means of facilitating and coordinating collaborative activities.

4. Related Activities

- (1) BRI and some private companies cooperatively conducted wind tunnel tests for some improvement of the BSL concerned with wind loads on buildings in 2009 - 2010.
- (2) The AIJ committee has revised AIJ Recommendations for Loads on Buildings (2004 Edition). The new edition will be completed in 2014.
- (3) ASCE 7 has revised and published ASCE 7-10. Major changes related to wind load provisions are as follows:
 - a) Basic design wind maps according to four risk categories
 - b) Strength level
 - c) Reorganization of wind load chapter

**Report of Task Committee G
TRANSPORTATION SYSTEMS**

Date: 29 August 2011

Place: National Institute for Land and Infrastructure Management, Tsukuba, Japan

Attendees:

U.S. Side --	David Sanders (Acting Chair)	UNR
Japan Side --	Tetsuro Kuwabara (Chair)	PWRI
	Kazuhiko Kawashima	TIT
	Jun-ichi Hoshikuma	PWRI
	Hideaki Nishida	PWRI

1. Objective and Scope of Work

The objectives of work include:

- (1) To plan, promote and foster research on the behavior of transportation facilities when subjected to wind and seismic forces, and
- (2) To disseminate research results and provide specifications and guidelines based on the Task Committee's findings.

The scope of work includes:

- (1) To investigate existing and new bridges design, the behavior of whole bridge systems and/or single component of a bridge without limitation on their size and function.

2. Accomplishments

- (1) The proceedings of the 26th US-Japan Bridge Engineering Workshop, which was held during 20-22 September 2010, in New Orleans, LA, U.S., were printed and distributed. The program and papers of the workshop were posted on the website of the Panel on Wind and Seismic Effects, UJNR at PWRI (http://www.pwri.go.jp/eng/ujnr/tc/g/tc_g.htm) and FHWA.
- (2) The joint reconnaissance of highway bridge damage due to the 2011 Great East Japan Earthquake was performed during 3-6 June 2011. 6 U.S. and 7 Japanese participants attended it and total of 11 bridges were investigated.
- (3) Both sides conducted post earthquake damage evaluation study in Chile Maule Earthquake in March - April 2010, and the information has been exchanged.

3. Future Plans

- (1) The 27th US-Japan Bridge Engineering Workshop will be held during 7-9 November 2011, in Tsukuba, Japan. Specific program and itinerary will be proposed by the Japan-side Task Committee G with the concurrence of the US-side Task Committee G.
- (2) The joint reconnaissance report of bridge damage will be posted on the website of the Task Committee G, Panel on Wind and Seismic Effects, UJNR, so that the selected significant pictures in high resolution format can be downloaded worldwide by researchers and engineers.
- (3) Following a devastating earthquake or hurricane (typhoon) in the US or Japan, the committee will form a joint reconnaissance team to investigate the performance of transportation systems.
- (4) With increasing concerns over structural member fractures of older bridges in the US and Japan, the committee will conduct joint efforts to investigate detection methods, causes and repairs. The joint efforts should be initiated by the hosting side.
- (5) Both sides agreed to conduct joint researches and share technical information on the following topics.
 - a) Strategy to determine design criteria, design loads, and load factors that consider ductility and

- redundancy for multiple hazards
 - b) Best and poor practices in bridge design and maintenance
 - c) Post earthquake response and repair
 - d) Study on policy making to set different performance levels of routes and allocate resources for seismic upgrading/retrofit, bridge inspection, and rehabilitation based on the assigned characteristics
 - e) Impact of seismic design of long duration earthquakes
 - f) Applications of high performance materials (Nano, SMA and UHPC) in seismic design and retrofitting
 - g) Study of tsunami effects on bridge performance in cooperation with Task Committee H
- (6) Both sides agreed to have personnel exchange for young engineers in sharing research activities and technical information.

4. Related Activities

- (1) Task committee G members supported the investigation of transportation systems by the ASCE Technical Council on Lifeline Earthquake Engineer.

Report of Task Committee H STORM SURGE AND TSUNAMI

Date: 29 August 2011

Place: National Institute for Land and Infrastructure Management, Tsukuba, Japan

Attendees:	U.S. Side --	Solomon Yim (Chair)	OSU
		Gary Chock	Martin & Chock, Inc.
		Long Phan	NIST
	Japan Side --	Takashi Tomita (Chair)	PARI
		Toshikazu Kabeyasawa	BRI
		Masaomi Nakamura	MRI
		Yasuo Okuda	BRI

1. Objective and Scope of Work

The objectives of work include:

- (1) To exchange scientific and technical information
- (2) To jointly plan, promote and foster research and dissemination of knowledge
- (3) To develop measures to prevent and mitigate damages from storm surges and tsunamis

The scope of work includes:

- (1) Perform joint research on storm surge and tsunami occurrences, generation, propagation, and coastal effects. Develop database on storm surge, tsunami and wave measurements.
- (2) Improve coordination of strategies and systems for observations of storm surges and tsunamis by field surveys, satellites, and in-situ measurements.
- (3) Exchange results and status of storm surge and tsunami mitigation activities including analysis of the problem, planning, warning, and engineering approaches.
- (4) Exchange information on development of technologies including numerical models to predict propagation processes, landfall locations, inundation and run-up heights, and wave characteristics, improved instrumentation, and use of satellite communication for detection and warning.
- (5) Facilitate research result and technology development disseminations through exchange of literature, technical reports at joint meetings, special workshops, joint projects, and direct interaction among participants.
- (6) Develop planning, design and construction guidelines in storm surge and tsunami flooding zones to serve as a model for international standards.
- (7) Provide technical support to develop storm surge and tsunami mitigation programs worldwide.
- (8) Encourage conduct of joint investigation following storm surge and tsunami events in cooperation with Task Committees D and G.

2. Accomplishments

- (1) Most of the panel members on both the US and Japan sides participated in surveys of the 2011 Great East Japan Earthquake Tsunami (e.g., ASCE groups 1 and 2, and the EERI/PEER group).
- (2) Panel members of both US and Japan participated in numerical simulations of tsunami propagation and structural damage of the 2011 Great East Japan Earthquake Tsunami.

3. Future Plans

- (1) Create joint research between the US and Japan to develop and improve numerical models of storm surge and tsunami dynamics and to exchange experimental and field data. The following topics have

been identified as areas of future research collaboration on storm surges and tsunamis:

- a) field observation
 - b) characterization
 - c) physical experiment models
 - d) numerical simulation models
 - e) effects on coastal structures and damage estimations
 - f) design of protective structures for different levels
 - g) hazard maps development and warning system design
 - h) storm surge and tsunami information communication and warning systems development
 - i) risk assessment including hazard beyond designed levels
- (2) Develop database for existing and planned experiments including description and parameters of experiments to maximize overall available experimental data for understanding of physical behavior, numerical model validation and structural design.
 - (3) Include the effects of global warming on atmospheric and oceanographic environmental conditions leading to changes in the probability of occurrence and intensity of typhoons, cyclones and hurricanes, and sea level rise. These changes in typhoon and sea level characteristics will directly influence the characteristics and induced damages of future storm surges and tsunamis.
 - (4) Collaborate with T/C D on Winds to develop storm surge research.
 - (5) Collaborate with T/C G on Bridges on tsunami impact design.
 - (6) Explore possibility of holding a UJNR Panel Meeting at a future natural hazard conference.

4. Related Activities

- (1) Japan side T/C members have cooperative research activities with the Technical Committee on Estimation and Reduction Technologies on Multi-Hazards of Earthquake and Tsunami, Japan Society of Civil Engineers.
- (2) Japan side T/C members have cooperation with Japan local and central government on planning of recovery and reconstruction policies, and improvement of design codes of buildings, bridges and other structures.
- (3) US side T/C members are participating in developing tsunami design provisions for the ASCE 7 standard applicable to buildings and other structures.
- (4) US side T/C members have several on-going research projects on tsunami and storm surge numerical modeling and experiments at the HWRL of OSU, and research at NIST on risk quantification for design of coastal structures exposed to combined hurricane wind and storm surge effects.
- (5) Several US panel members participated in the ASCE 7 Tsunami Loads and Effects Committee in the July 2011 meeting in Hawaii.
- (6) The 8th International Workshop on Coastal Disaster Prevention will be held on September 8, 2011 in Tokyo, Japan, organized by the Port and Airport Research Institute, the Coastal Development Institute of Technology, and the Ministry of Land, Infrastructure, Transport and Tourism of Japan, in cooperation with the US, Chile and Indonesia.

Task Committee A Charter

1. Name of Task Committee

Strong Motions and Effects

2. Lead Agency and Task Committee Chairmen

U.S.-Side:	Mehmet Çelebi	USGS
	Nicolas Luco	USGS
Japan-Side:	Izuru Okawa	BRI
	Masanori Iiba	BRI

3. Participating Agencies and their Representatives

U.S.-Side:	Mehmet Çelebi	USGS
	Nicolas Luco	USGS
	Roger Borchardt	USGS
	John Ake	US-NRC
	Vladimir Graizer	US-NRC
	Erol Kalkan	USGS
Japan-Side:	Izuru Okawa	BRI
	Masanori Iiba	BRI
	Shojiro Kataoka	NILIM
	Tatsuya Azuhata	NILIM
	Shin Koyama	BRI
	Toshihide Kashima	BRI
	Koichi Morita	BRI

4. Function of Task Committee

1) Objective

The main objectives of the task committee are:

- (1) To promote sharing of strong motion earthquake data among researchers and practicing engineers, and enhance the availability of technology for evaluating the destructive effects of earthquake motion.
- (2) To promote, and when feasible, conduct collaborative research with other task committees of the Wind and Seismic Effects Panel on the dynamic behavior of structures.
- (3) To promote and coordinate research on ground motion characterization, ground motion prediction and processing, and site-characterizations as applied to structural design considerations in building codes and other standards.

2) Scope of Work

The scope of work includes:

- (1) Exchange strong motion data and associated meta-data regularly and identify significant issues.
- (2) Exchange information on technological developments, state-of-the-art and practice related to strong motion recording, archiving and processing, design

ground motion estimation, hazard mapping, selection and modification of recordings for dynamic structural analysis, soil-structure interaction, soil behavior, and stability during earthquakes.

- (3) Coordinate, and when feasible, plan and conduct programs of cooperative research and/or workshops in coordination with the proposed or ongoing programs. Disseminate results of workshops.

3) Plan of Cooperative Activities during 2011-2013

- (1) Joint studies on recorded motions obtained during the recent damaging earthquakes, including the 2011 Great East Japan Earthquake from buildings and other structures. The studies include/require:
 - a. Exchange of data, meta-data related to the buildings and other structures from which data have been recorded.
 - b. Understanding the effect of long-period ground motions to tall buildings and long-period structures.
 - c. Determine the variation of structural characteristics of damaged buildings during the events.
 - d. Study data for correlation with damage detection methodologies.
 - e. Developing better instrumentation methods to obtain improved data during future events.
 - f. Exchange of data on the near source ground motions to study impacts on design considerations.
- (2) As a result of numerous recorded free-field data during the recent events:
 - a. Study how they may affect design response spectra in Japan and the USA.
 - b. Study site response issues, including topographical effect in particular, testing the transfer function procedures (e.g. Nakamura method)
- (3) Exchange of information on the seismic hazard mapping for improving structural design
- (4) Other activities as appropriate and events dictate

CHARTER

CHARTER OF THE UJNR PANEL ON WIND AND SEISMIC EFFECTS

OBJECTIVES

- 1) Encourage, develop, and implement the exchange of wind and seismic technology between appropriate United States and Japanese organizations to share scientific and technological knowledge.
- 2) Develop strong technical links of scientific and engineering researchers between the two countries and encourage exchanges of guest researchers.
- 3) Conduct joint research in areas of winds and seismic technology including exchange of available research equipment and facilities in both countries. Publish findings from joint research efforts.
- 4) Conduct cooperative programs to improve engineering design and construction practices and other wind and earthquake hazard mitigation practices. Publish results from cooperative programs.

CURRENT TOPICS AND SUBJECT AREAS OF INTEREST

- 1) Strong Motion Instrumentation Arrays and Data
- 2) Large Scale Testing Program
- 3) Repair and Retrofit of Existing Structures
- 4) Evaluation of Performance of Structures
- 5) Natural Hazard Assessment and Mitigation Through Land Use Programs
- 6) Disaster Prevention Methods for Lifeline Systems
- 7) Wind Characteristics and Structural Response
- 8) Soil Behavior and Stability During Earthquakes
- 9) Storm Surge and Tsunamis
- 10) Wind and Earthquake Engineering for Transportation Systems

COOPERATIVE ACTIVITIES

- 1) Conduct annual joint panel meetings alternating locations between the United States and Japan.
- 2) Publish proceedings of annual meetings and of task committee events.
- 3) Exchange data and information between both countries.
- 4) Exchange guest scientists and engineers.
- 5) Develop cooperative research programs on mitigating the effects of wind and seismic forces on structures. Concerning these programs, exchange available research equipment and facilities in both countries, if necessary.
- 6) Conduct task committee meetings and workshops in areas identified in “Current Topics and Subject Areas of Interest” to facilitate exchange of technical information.
- 7) Establish and maintain effective communications between scientists, engineers, and administrators of the two countries.

PANEL MEMBERSHIP

- 1) Members of the panel are personnel of government agencies designated by the agencies.
- 2) Other experts may be selected, as temporary members, from appropriate disciplines representing industry, academia, and research organizations.

CHARTER MODIFICATIONS

This Charter may be revised by the concurrence of the US and the Japanese sides.